

STEEL FLOOR DECK CATALOG VF5



VERCO DECKING, INC.

a NUCOR company



VERCO DECKING, INC.

HONORING THE PAST | CELEBRATING THE PRESENT | EMBRACING THE FUTURE

1964 HONORING OUR PAST

Since our start in 1964, testing has been a key to the innovative products Verco has introduced to the market:

- ShearTranz® System
- System 80
- FORMLOK™ System
- ShearTranz® II System
- PunchLok® System

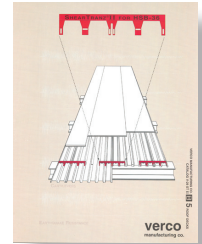

CELEBRATING THE PRESENT

Innovative high quality products combined with our teammates dedication to excellence and superior service are fundamental to Verco's success. We strive to be the deck supplier of choice by being the safest, most innovative and most productive steel deck company in the world.



2014 EMBRACING THE FUTURE

Verco is pleased to begin our second 50 years of service to the construction community with the introduction of the N3 roof and floor deck profiles and the PunchLok II System.

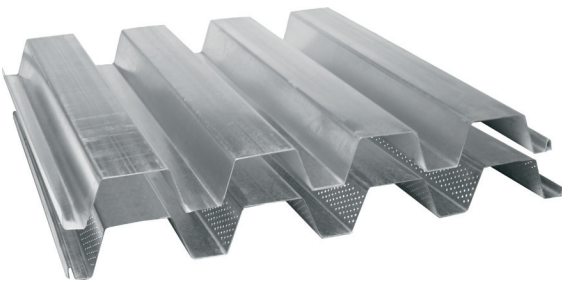

PLN3™/HSN3™/N3

The Verco N3 roof and floor deck profiles have a 32" cover width. This additional cover width results in fewer sheets to spread and less sidelaps to fasten. The N3 profile offers superb shear strength with fewer support and sidelap fasteners to install.



PUNCHLOK® II SYSTEM

Building on the success of the industry changing PunchLok System, the Verco PunchLok II System provides an even stronger sidelap connection with the same benefits of the original PunchLok System including simple visual inspection, consistency, and efficiency.

CATALOG CONTENTS

VERCO® PROFILES	2
TECHNICAL GUIDELINES	3
PLB™ FORMLOK™ and B FORMLOK™ DECK	37
PLW2™ FORMLOK™ and W2 FORMLOK™ DECK	49
PLW3™ FORMLOK™ and W3 FORMLOK™ DECK	67
PLN3™ FORMLOK™ and N3™ FORMLOK™ DECK	85
PLN™ FORMLOK™ and N FORMLOK™ DECK	97
CELLULAR FORMLOK™ DECK	109
DEEP & SHALLOW VERCOR™ NON-COMPOSITE and PLB & HSB FORMLOK™ FORM DECK	127

COMMON VERCO® PROFILES



PLB™ and B FORMLOK™
1½" Deep, 36" Wide



PLB™-CD AC and BCD AC FORMLOK™
1½" Deep, 36" Wide
(Non-Acoustic Versions Available)



PLW2™ and W2 FORMLOK™
2" Deep, 36" Wide

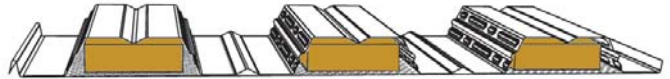

PLW2™-CD AC and W2CD AC FORMLOK™
2" Deep, 36" Wide
(Non-Acoustic Versions Available)



PLW3™ and W3 FORMLOK™
3" Deep, 36" Wide

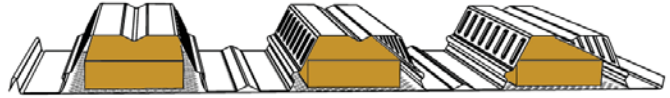

PLW3™-CD AC and W3CD AC FORMLOK™
3" Deep, 36" Wide
(Non-Acoustic Versions Available)



PLN3™ and N3 FORMLOK™
3" Deep, 32" Wide

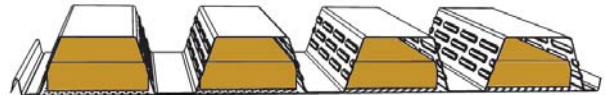

PLN3™-CD AC and N3CD AC FORMLOK™
3" Deep, 32" Wide
(Non-Acoustic Versions Available)

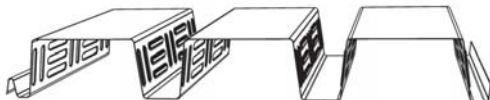

PLN™ and N FORMLOK™
3" Deep, 24" Wide

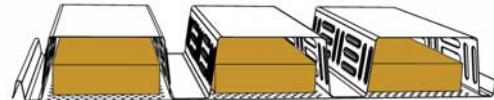

PLN™-CD AC and NCD AC FORMLOK™
3" Deep, 24" Wide
(Non-Acoustic Versions Available)



Shallow VERCOR™
9/16" Deep, 36" Wide

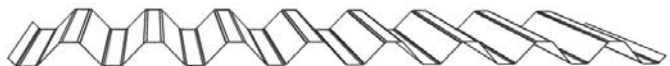

Deep VERCOR™
1⁵/₁₆" Deep, 36" Wide

TECHNICAL GUIDELINES CONTENTS

Profile Designations	4
Material	4
Floor Deck Vertical Loads	5
Superimposed Load Tables	5
Uniform Load Tables	5
Concentrated Loads	5
Parking Structures	6
Moving/Vibratory Loads	6
Hanging Loads	6
Overhanging Deck	6
Floor Deck Concrete Fill	7
Concrete Reinforcing	7
Concrete Type	7
Concrete Thickness	7
Floor Deck Design Considerations	7
Composite Slab Floor Vibrations	7
Fire-Rated Composite Slabs	8
Venting Floor Deck	8
Floor Deck Diaphragms	9
Attachment of Floor Deck	10
Support Fastening	10
Steel Headed Stud Anchors/Arc Spot Welds	10
Mechanical Fasteners to Supports	11
Sidelap Connections	11
Parallel Collectors	12
Verco Floor Deck Finishes	13
Floor Deck During Construction	14
Spans	14
Gage Selection	15
Concrete Placement	15
Bearing	15
Design Criteria for Deck-as-a-Form	16
Design Formulas	16
FORMLOK Composite Slab Design Example	18
Design Goals	18
Span Options	18
Concrete Type & Fire Rating Options	18
FORMLOK Deck Options	19
Specific Considerations	19
Concrete Volumes and Weights	20
Steel Headed Stud Anchors	22
FORMLOK Composite Slab—Suggested Details	27
Edge Form Suggestions	28
Floor Deck Accessories	29
Openings in FORMLOK Decks	30
FORMLOK Composite Slab Fire Resistance Ratings	32
Acoustical Cellular FORMLOK Deck	34
Specification Section 05 31 13 - Steel Floor Decking	35
Using the Tables	36
Metric (SI) Conversions	141

VERCO® FLOOR DECK TECHNICAL GUIDELINES

VERCO® FORMLOK™ and VERCOR™ floor decks provide savings by the elimination of temporary forms and shoring, and allow for immediate use of the deck as a working platform for all trades. Verco FORMLOK floor decks provide positive reinforcing of the one-way slab due to the mechanical bond between the deck and the concrete thus creating an effective composite slab. FORMLOK deformations and indentions (embossments) have been specifically designed to provide optimal vertical load capacity.

PROFILE DESIGNATIONS

Deck for PunchLok® II Systems:

- PLB FORMLOK, PLB-CD FORMLOK, and PLB-CD AC FORMLOK
- PLW2 FORMLOK, PLW2-CD FORMLOK, and PLW2-CD AC FORMLOK
- PLW3 FORMLOK, PLW3-CD FORMLOK, and PLW3-CD AC FORMLOK
- PLN3 FORMLOK, PLN3-CD FORMLOK, and PLN3-CD AC FORMLOK
- PLN FORMLOK, PLN-CD FORMLOK, and PLN-CD AC FORMLOK

Deck for Button Punch and Top Seam Weld Sidelaps:

- B FORMLOK, BCD FORMLOK, and BCD AC FORMLOK
- W2 FORMLOK, W2CD FORMLOK, and W2CD AC FORMLOK
- W3 FORMLOK, W3CD FORMLOK, and W3CD AC FORMLOK
- N3 FORMLOK, N3CD FORMLOK, and N3CD AC FORMLOK
- N FORMLOK, NCD FORMLOK, and NCD AC FORMLOK

Deck for Screwed Sidelaps:

- B FORMLOK-SS (Interlocking Screwed Sidelap)
- W2 FORMLOK-SS (Interlocking Screwed Sidelap)
- W3 FORMLOK-SS (Interlocking Screwed Sidelap)
- N3 FORMLOK-SS (Interlocking Screwed Sidelap)
- N3 FORMLOK-NS (Nestable Screwed Sidelap)
- N FORMLOK-SS (Interlocking Screwed Sidelap)
- Shallow VERCOR (Nestable Screwed Sidelap)
- Deep VERCOR (Nestable Screwed Sidelap)

MATERIAL

Galvanized FORMLOK deck panels are formed from either ASTM A653 or A1063 steel. Phosphatized/painted FORMLOK deck panels are formed from either ASTM A1008 or A1039 steel.

Cellular FORMLOK deck sections are fabricated from galvanized steel conforming to ASTM A653 or A1063. The fluted top and flat bottom sections are factory resistance-welded together.

Note: Weld marks will be visible on the exposed flat bottom.

Shallow and Deep VERCOR decks are fabricated from G90 galvanized steel conforming to ASTM A653 or A1063.

FLOOR DECK VERTICAL LOADS

Superimposed Load Tables

The FORMLOK deck with concrete fill tables in this catalog list the Allowable Superimposed Loads. This is the uniform load in addition to the weight of concrete and FORMLOK deck that the composite slab can support based on concrete with a minimum 28-day compressive strength of 3,000 psi.

FORMLOK slab capacity is based on the composite slab acting as a one-way, simply supported single span slab. The immediate deflection of the composite slab due to allowable superimposed load is limited to $L/360$.

The allowable superimposed loads listed in the tables are limited to 400 psf for all FORMLOK decks with concrete fill. Contact the Verco Engineering Department when using heavier loads. Such loads often indicate conditions, such as concentrated or long-term loadings, that may require further evaluation.

Uniform Load Tables

The allowable uniform load values for FORMLOK decks without concrete fill and VERCOR decks are based on the allowable bending moment (stress) and limiting deflection to $L/360$, $L/240$ or $L/180$. Allowable uniform load values for cellular deck panels are also governed by the allowable vertical shear (governed by the horizontal shear strength of the resistance welds between the fluted top section and the flat bottom section).

The formulas used to determine the allowable uniform loads for FORMLOK decks without concrete fill and VERCOR decks due to flexure (stress), shear and deflection are listed on page 5 of the VERCO Roof Deck Catalog VR4.

Refer to Verco's Evaluation Report or Verco's Roof Deck Catalog VR4 for allowable uniform load values for B, N3 and N FORMLOK decks without concrete fill. Note that the FORMLOK indentations (embossments) do not impact vertical load capacity of panels without concrete fill.

Concentrated Loads

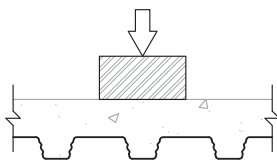

An allowable concentrated load (based on an effective width of slab determined using structural engineering principles) on the FORMLOK composite slab can be determined by comparing moments and shears from the allowable superimposed loads to those from the actual superimposed loads.

Since the deck provides only positive reinforcing, composite slabs are assumed to be simple spans, even though the deck alone may be evaluated as multiple spans during construction.

Composite slabs should be evaluated for concentrated / moving loads from construction equipment such as manlifts.

Note: Additional reinforcing (distribution steel) or other means to distribute the load may be required.

Parking Structures

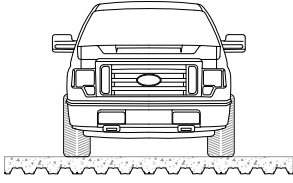

FORMLOK deck has been used successfully in parking structures. When used in such structures we suggest:

- **Do not** use where salt is used for snow or ice removal. Salt from vehicles may deteriorate the FORMLOK deck by penetrating the slab through cracks.
- A 3 in. minimum depth of concrete should be used over the top of the FORMLOK deck.
- Instead of welded wire fabric (WWF), use rebars perpendicular to the FORMLOK deck flutes as distribution steel and rebars parallel to the FORMLOK deck flutes for shrinkage. Consider use of the parallel rebars as negative reinforcement.
- Seal the surface of the concrete slab to prevent water from seeping into the slab and deteriorating the deck.

Moving/Vibratory Loads

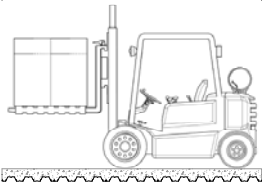

Allowable superimposed loads are based on static loading. FORMLOK composite slabs should not be used where heavy vibratory loads or heavy moving loads might occur. These types of loads may be detrimental to the bond between the deck and concrete. Where moving loads such as forklifts occur, it is suggested that the concrete slab be designed as reinforced concrete to carry the superimposed loads, with the deck acting only as a permanent form.

Hanging Loads

Where loads hanging from the composite slab are anticipated, the hangers should be embedded in the concrete slab rather than connected only to the deck. The FORMLOK composite slab selected should be evaluated based on the actual loading condition (concentrated load from the hanger plus uniform load).

Overhanging Deck

If FORMLOK or VERCOR deck is overhanging, it is non-composite, and acts as a form only. The length of the overhang can be determined by using the deck section properties. Negative steel may be added over the supporting beam to help minimize cracking and to reinforce the slab for superimposed loads. An alternate approach is to select the deck alone to meet the total load requirements. See Figure 1.

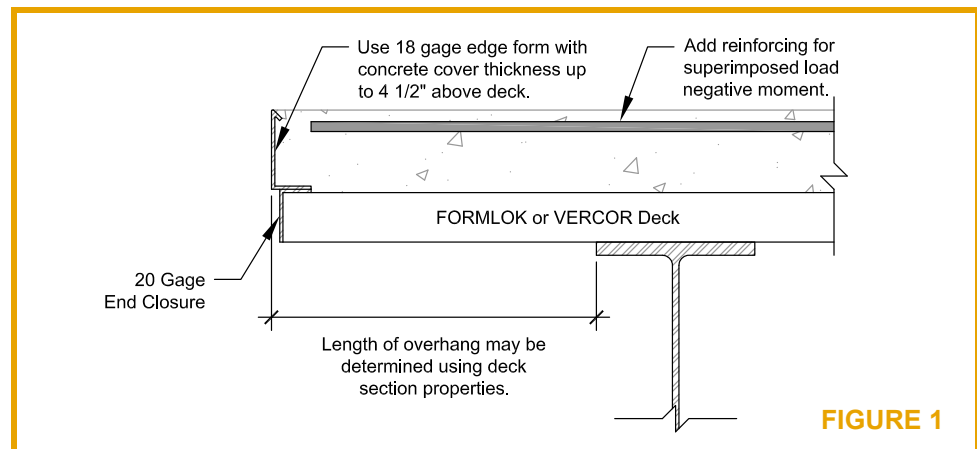

FLOOR DECK CONCRETE FILL

Concrete Reinforcing

Reinforcement for temperature and shrinkage crack control should be provided by welded wire fabric (WWF), reinforcing bars or fibers.

Welded wire fabric or reinforcing bars with an area equal to 0.00075 times the area of concrete fill over the FORMLOK deck, but not less than the area provided by 6 x 6 - W1.4 x W1.4 WWF is required.

Steel fibers meeting the criteria of ASTM A820, Types I, II or V, may be used in concrete specified in accordance with ASTM C1116, Type I. Follow the steel fiber manufacturer's recommended dosage rate, but not less than 25 lbs/yd³.

Macro synthetic fibers meeting the criteria of ASTM D7508 may be used in concrete specified in accordance with ASTM C1116, Type III. Follow the macro synthetic fiber manufacturer's recommended dosage rate, but not less than 4 lbs/yd³.

Use of alternative fibers or combinations of fibers, which the designer is satisfied will effectively resist temperature and shrinkage cracking, should be based on the fiber manufacturer's recommended dosage rate.

The use of fibers may affect the choice of UL assemblies if a fire-rated composite slab is required.

Concrete Type

The decision to use normal weight (NW) or structural light weight (LW) concrete is typically based on the relative costs and availability. The dead load of structural concrete slabs vary considerably with concrete type. Table 4 lists the concrete weight to be added to the deck weight to determine slab dead load.

Note: The concrete weights listed in Table 4 do not include the allowance for deck deflection discussed on page 16.

Concrete Thickness

A minimum 2 in. thickness of concrete over the FORMLOK deck is required to achieve composite action. A 2½ in. thickness is suggested for better stiffness of the composite slab. Greater thickness may be required to attain fire ratings or meet specific load requirements.

FLOOR DECK DESIGN CONSIDERATIONS

Composite Slab Floor Vibrations

FORMLOK composite slab stiffness increases as the span to total slab depth ratio decreases. Span to depth ratios in the low to mid-20s are suggested. Evaluation of floor vibrations must consider the entire floor assembly, including the slab and supporting structure. "Floor Vibrations Due to Human Activity" (AISC Steel Design Guide Series 11) is one source of additional information.

Fire-Rated Composite Slabs



FORMLOK composite slabs may be used to meet hourly fire ratings. The type and thickness of concrete specified will determine whether fireproofing will be required on the underside of the FORMLOK deck. Typically 2½ in. of concrete over the top of the deck is required for fire ratings with fireproofing on the underside of the deck. Refer to the specific UL assembly, or use the fireproofing manufacturer’s data to determine fireproofing thickness required to meet a specific hourly rating.

Table 1 summarizes the thickness of concrete required over the top of the FORMLOK deck to achieve restrained unprotected hourly ratings with no fireproofing on the underside of the deck. See specific UL assemblies for unrestrained hourly ratings.

**Table 1: Unprotected Fire Resistance Rating
Concrete Thickness over FORMLOK Deck**

Restrained Assembly Rating	Normal Weight (in.)	Light Weight (in.)
1 Hour	3½	2½
2 Hour	4½	3¼
3 Hour	5¼	4¾

Refer to Table 9 on pages 32–33 for a listing of UL fire-rated assemblies utilizing FORMLOK profiles. Refer to the particular UL assembly being considered for full details of construction, including specific information about concrete thickness, strength requirements, and span limitations.

Venting Floor Deck

Factory vent tabs are available as an option for FORMLOK deck as shown in Figure 2. The structural performance and fire rating of the FORMLOK composite slab are not affected by the venting.

The drying performance of concrete cast on steel deck can be expected to be similar to that of a slab cast on grade over a vapor barrier. The nominal venting provided by vent tabs will not significantly affect concrete drying. Vent tabs should only be specified based on the requirements of the materials installed over the slab. Leakage will occur during concrete placement with vented deck.

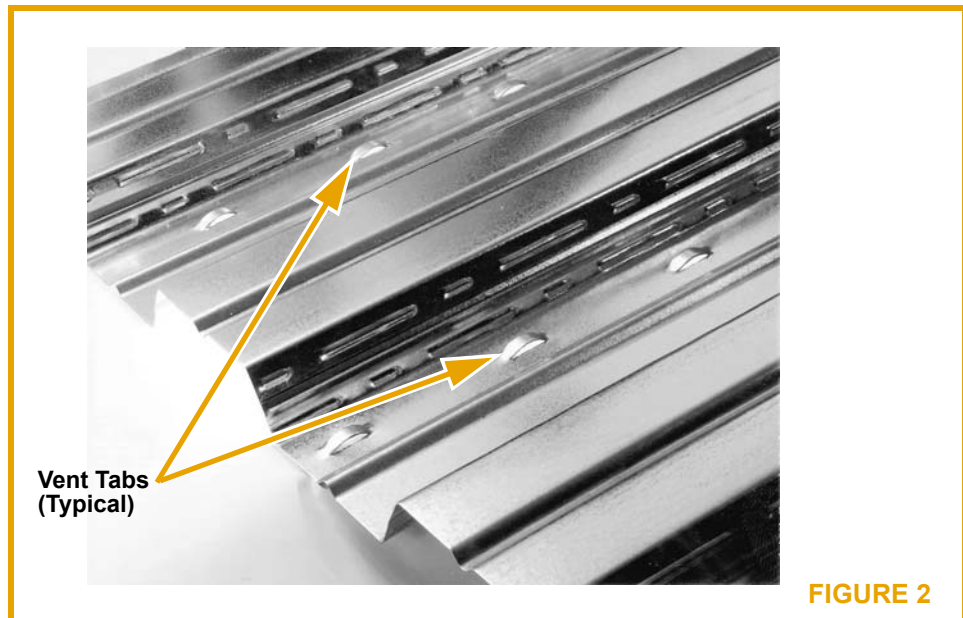
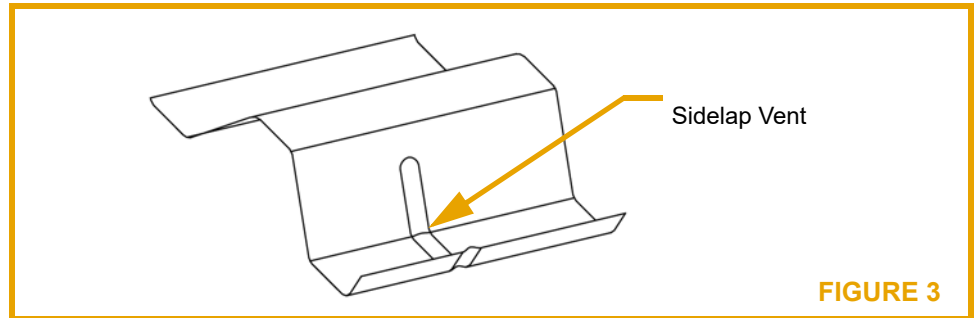

FIGURE 2

Vent tabs projecting upwards are staggered in interior low flutes at approximately 6 in. on center:

- 5 rows in PLB and B FORMLOK.
- 3 rows in PLW2 and W2 FORMLOK, and PLW3 and W3 FORMLOK (each low flute except at male side joint).
- 3 rows in PLN3 and N3 FORMLOK.
- 2 rows in PLN and N FORMLOK.

Shallow and Deep VERCOR decks are available with rolled-in sidelap vents as shown in Figure 3. Vents are spaced at approximately 10 in. on center.



FLOOR DECK DIAPHRAGMS

Diaphragm Load Tables

The allowable diaphragm shear strengths in the FORMLOK deck tables are based on the attachment of the deck to the perpendicular supports with puddle welds. Mechanical fasteners may be used in lieu of puddle welds as described below.

Allowable diaphragm shear strength tables for VERCOR deck with structural concrete fill are based on attachment of the deck to the perpendicular supports with minimum #12 SDI recognized self-drilling self-tapping screws.

The attachment patterns for each profile are shown in the illustrations following the section properties for each profile. The attachments to the supports provide shear transfer between the deck and the structure.

Increased diaphragm shear values may be achieved when steel headed stud anchors are used. Refer to Table 5 on page 22 for further information about concrete diaphragms using steel headed stud anchors.

- The allowable stress increase permitted for load combinations in IBC Section 1605.3.2, including wind or seismic forces, shall not be used for allowable diaphragm shear strengths.
- The flexibility factor (F) is the number of micro-inches a diaphragm web will deflect in a span of 1 ft under a shear load of 1 pound per ft.
- Allowable diaphragm shear strengths and flexibility factors for concrete-filled decks apply to either FORMLOK deck or deck without deformations or indentations (embossments).

- Allowable diaphragm shear strengths for FORMLOK deck fastened to supports with mechanical fasteners should be determined by multiplying the puddle weld diaphragm shear strengths in the diaphragm tables by the adjustment factors shown in the diaphragm table footnotes.
- Allowable diaphragm shear strengths and flexibility factors for FORMLOK decks with structural concrete fill are not affected by the choice of sidelap connection and apply whether the sidelaps are fastened or not. Connection of the sidelaps is suggested to resist construction loads and may be required to meet fire rating requirements.
- Allowable diaphragm shear strengths and flexibility factors for VERCOR decks with structural concrete fill are based on minimum #10 screws at the sidelaps for the spacings shown in the tables on pages 134-139.
- Allowable diaphragm shear strengths and flexibility factors for PLW2, W2, PLW3, and W3 FORMLOK decks used without concrete fill are provided on pages 64–65 and 82–83 of this catalog.

Floor Deck Without Concrete Fill

Refer to Verco's Evaluation Report or Verco's Roof Deck Catalog VR4 for diaphragm values for B, N3 and N FORMLOK decks and VERCOR decks without concrete fill. Note that the FORMLOK indentations (embossments) do not impact shear strength or flexibility of panels without concrete fill.

ATTACHMENT OF FLOOR DECK

Support Fastening



FORMLOK deck is to be welded to supports with arc spot (puddle) welds having an effective fusion diameter of at least ½ in., or arc seam welds having an effective fusion width of at least ¾ in. x 1 in. long (excluding the circular ends) as shown in Figure 4. Arc seam and arc spot welds are to be located and spaced as described in the tables. Welds are to be spaced not more than 12 in. on center across the width of the unit for all FORMLOK decks to meet UL requirements.

VERCOR deck with structural concrete fill is to be attached to supports with minimum #12 SDI recognized self-drilling self-tapping screws.

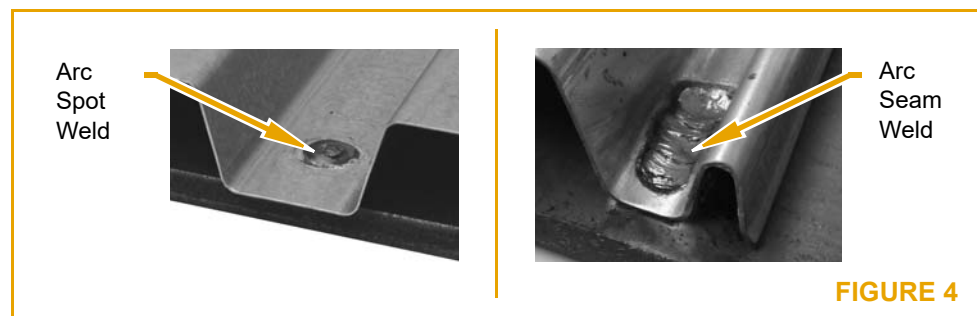

FIGURE 4

Steel Headed Stud Anchors/Arc Spot Welds

Arc spot welds may be eliminated where they coincide with steel headed stud anchors. If FORMLOK or VERCOR deck with concrete fill is attached to the supports with steel headed stud anchors, refer to Table 5 on page 22 for allowable diaphragm shear strengths and flexibility factors.

Mechanical Fasteners to Supports

As an alternate to welds, FORMLOK deck may be attached to the supports with mechanical fasteners, specifically, Hilti Fasteners, Pneutek Fasteners, and SDI recognized #12 or #14 screws from Buildex, Elco, Hilti, and Simpson. Allowable shear strengths for FORMLOK decks attached with mechanical fasteners are determined by multiplying the allowable diaphragm shear strengths for deck attached with welds by the adjustment factors shown in the diaphragm table footnotes for each FORMLOK profile and attachment pattern.

Comply with minimum and maximum substrate thickness requirements for applicable mechanical fasteners. Consult fastener manufacturer for applicable fire-resistance assembly ratings.

Sidelap Connections

FORMLOK deck is to be fastened at the sidelap with the PunchLok II tool, button punches, screws, or 1½ in. long top seam welds at 36 in. on center maximum. VERCOR deck is to be fastened at the sidelaps with screws at the spacing shown in the tables.

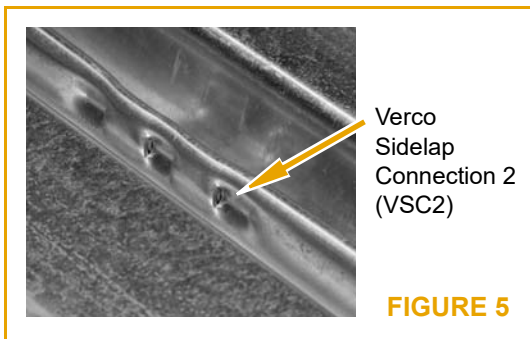

PunchLok® II System: Connect sidelaps of the PLB, PLW2, PLW3, PLN3, and PLN FORMLOK decks with the Verco PunchLok II tool. The PunchLok II tool creates a positive connection between the male and female lips of the FORMLOK decks. The connection made by the PunchLok II tool is referred to as a VSC2 (Verco Sidelap Connection 2). An acceptable VSC2 connection has been made when the sidelap material has been sheared and offset so the sheared surface of the male leg is visible (Figure 5). The VSC2 connection may be made in either direction.



Button Punches: When sidelaps of FORMLOK decks are connected with button punches (BP), as shown in Figure 6, an average-sized person should be able to stand (not jump) on the flange adjacent to the attachment without the joint coming apart.

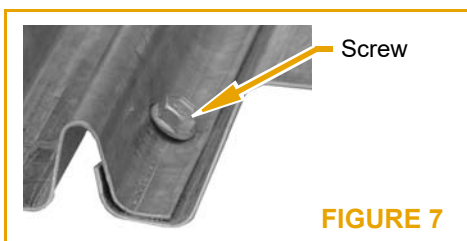
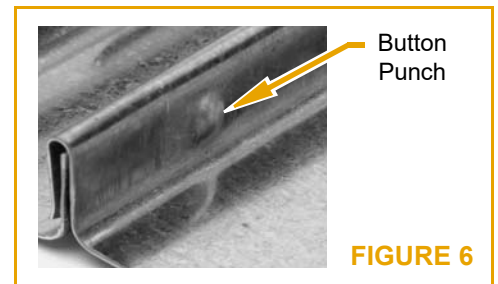

Screws: When self-drilling, self-tapping screws are used to connect the sidelaps of B-36-SS, W2-36-SS, W3-36-SS, N3-SS, N3-NS, or N-24-SS FORMLOK decks, they are to be minimum #10 x ¾ in. long. The “SS” designation indicates deck provided with modified female lip for screw fastening. See Figure 7. The “NS” designation for N3 FORMLOK deck indicates deck provided with nested sidelap. Shallow and Deep VERCOR decks have a nested sidelap.

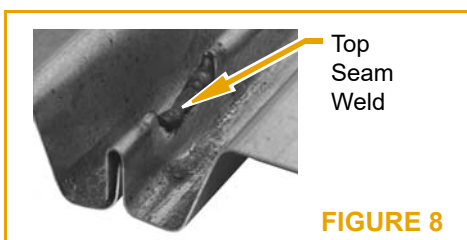

Top Seam Welds: When sidelaps of FORMLOK decks are connected with top seam welds (TSW) (Figure 8), the 1½ in. long weld must engage the top of the inner (male) leg. Clinch the joint before welding to create positive contact between the lips.

Consider the PunchLok II system as a cost-effective alternative to top seam welds.

Parallel Collectors

Spacing of the connections at diaphragm chords, struts, ties or other collector elements that are parallel to the deck flutes shall be based on the actual shear to be transferred and shear strength of the connections used. The maximum spacing of connections at parallel collectors is 3 ft.

Allowable shear strengths for Arc Spot Welds, Arc Seam Welds, Hilti Fasteners, Pneutek Fasteners, and SDI Recognized Screws are listed in Table 2.

Table 2: Allowable Shear Strength (lbs/connection) for Arc Spot Welds, Arc Seam Welds, Hilti Fasteners, Pneutek Fasteners, and SDI Recognized Screws for Verco Deck Support Connections^{11,12}

Deck Gage	Profile ¹	BMT ²	ARC SPOT WELD ^{3,4}	ARC SEAM WELD ^{3,4}	HILTI ⁵ X-EDNK22 or X-HSN 24	HILTI ⁵ X-ENP-19	PNEUTEK ⁶ SDK61	PNEUTEK ⁶ SDK63	PNEUTEK ⁶ K64	PNEUTEK ⁶ K66	SDI RECOGNIZED SCREWS ^{7,8,9,10}
		(in.)	(lbs)	(lbs)	(lbs)	(lbs)	(lbs)	(lbs)	(lbs)	(lbs)	(lbs)
22	B, N & W3	0.0299	783	1231	603	650	618	691	694	736	561
	W2	0.0300	788	1236	605	652	620	693	697	739	563
21	W2 & W3	0.0330	936	1365	664	715	678	744	797	822	619
20	B, N & W3	0.0359	1091	1491	720	775	733	791	886	903	673
	W2	0.0360	1096	1495	722	777	735	792	889	906	675
19	B, N, W2 & W3	0.0420	1455	1758	837	901	846	884	1057	1079	788
18	W2	0.0470	1793	1981	932	1003	937	956	1184	1228	881
	B, N & W3	0.0478	1850	2017	947	1020	951	967	1204	1253	896
16	W2	0.0590	2280	2527	1155	1244	1145	1115	1457	1604	1106
	B, N & W3	0.0598	2309	2564	1169	1259	1158	1125	1474	1630	1121

Deck Gage	Profile ¹	BMT ²	SDI RECOGNIZED SCREWS ^{7,8,9,10}
		(in.)	(lbs)
26	9/16" SV	0.0179	376
	1-5/16" DV	0.0195	410
24	9/16" SV	0.0239	502
	1-5/16" DV	0.0254	533
22	9/16" SV	0.0299	628
	1-5/16" DV	0.0314	659
20	1-5/16" DV	0.0374	785

1. The profile designations used in this table apply to the profile families as summarized below:

- "B" – PLB & B FORMLOK deck
- "N" – PLN3, N3, N3-NS, PLN & N FORMLOK deck
- "W2" – PLW2 & W2 FORMLOK deck
- "W3" – PLW3 & W3 FORMLOK deck
- "9/16" SV" - 9/16 in. (Shallow) VERCOR deck
- "1-5/16" DV" - 1-5/16 in. (Deep) VERCOR deck

2. Base metal thickness (BMT) = specified minimum uncoated base metal thickness used in design. Deck subject to thickness tolerances as described in Section A2.4 of AISI S100.

3. The minimum arc spot weld effective fusion diameter, d_e , is 1/2 inch. The minimum arc seam weld effective fusion width, d_e , is 3/8 inch and the minimum arc seam weld length, L, is 1 inch excluding circular ends.

4. Details, workmanship, technique and qualification of welds must comply with AWS D1.3.

5. The Hilti fasteners are applicable to the following substrate thicknesses:
 - X-EDNK22: 1/8 in. ≤ substrate thickness ≤ 1/4 in.
 - X-HSN 24: 1/8 in. ≤ substrate thickness ≤ 3/8 in.
 - X-ENP-19: substrate thickness ≥ 1/4 in.
6. The Pneutek fasteners are applicable to the following substrate thicknesses:
 - SDK61 series: 0.113 in. ≤ substrate thickness ≤ 0.155 in.
 - SDK63 series: 0.155 in. ≤ substrate thickness ≤ 0.250 in.
 - K64 series: 0.187 in. ≤ substrate thickness ≤ 0.312 in.
 - K66 series: substrate thickness ≥ 0.281 in.
7. Select appropriate minimum #12 screw based on actual substrate thickness. This table is provided as a guide, proper selection should be verified based on the specific fasteners used.

Support Thickness	Fastener Designation
33 mil (0.0346") to 3/16"	#3 Drill Point
1/8" to 1/4"	#4 Drill Point
1/8" to 1/2"	#5 Drill Point

8. SDI recognized #12 or #14 screws to supports are limited to Buildex, Elco, Hilti, or Simpson Strong-Tie screws with a minimum substrate thickness of 0.0385 in.
9. The #12 screws are self-drilling self-tapping screws with a minimum washer diameter of 5/16-in. and a minimum washer thickness of 0.05 in. The screws must be compliant with ASTM C1513.
10. The allowable shear strength of the individual screws, as published by their manufacturer, must meet or exceed the allowable screw connection shear strengths listed above.
11. The strength is the ASD allowable connection shear strength, where Ω is 3.0 for welds and 2.5 for Hilti, Pneutek and SDI Recognized Screw fasteners. Convert ASD shear strengths to LRFD based on $\phi = 0.55$ for welds and $\phi = 0.65$ for Hilti, Pneutek and SDI Recognized Screw fasteners.
12. Allowable shear strength may not be increased for wind or seismic loading.

VERCO FLOOR DECK FINISHES

Verco floor decks are offered in various finishes:

Phosphatized/Painted

The bottom (exposed) side of FORMLOK deck produced from cold rolled steel conforming to ASTM A1008 or ASTM A1039 is painted with a heat-cured gray acrylic primer applied by a roller coat process. The top side of the deck in contact with the concrete is left uncoated. The formation of light rust on the top side before placement of the concrete is normal and is not detrimental to the FORMLOK deck or the composite slab. Verco gray primer is approved by UL for use in protected and unprotected fire-rated assemblies. Refer to Table 9 on pages 32–33 for specific listings.

Due to varying job site conditions, application methods, coating manufacturers, environmental conditions and expectations, it is essential to conduct a field test to determine compatibility of the field applied top coat with the Verco primer coat prior to full scale painting. Primer specifications are available from the Verco website (www.vercodeck.com). Verco is not responsible for topcoat compatibility.

Verco assumes no responsibility for adhesion of any spray applied fire-proofing material, nor any treatment, cleaning, or surface preparation of the deck required for the adhesion of the fire protection material.

Primer paint is intended to protect steel deck for a short period of exposure to ordinary atmospheric conditions. It should be considered an impermanent and provisional coating.

Minor aesthetic irregularities and/or imperfections may appear in the paint coating as a result of the manufacturing and handling processes.

Galvanized

Galvanized FORMLOK deck is produced from cold rolled zinc coated steel (ASTM A653 or ASTM A1063). Coating designation G60 is the standard zinc coating of the deck industry. Coating designation G90 is a heavier, more costly zinc coating sometimes specified for exposed exterior applications or other project specific requirements.

Shallow and Deep VERCOR form decks are fabricated from G90 galvanized steel conforming to ASTM A653 or A1063. Galvanized VERCOR deck can be considered as a permanent form. Uncoated decks should not be considered permanent forms; therefore, the reinforced slab should be designed for the total load. Uncoated VERCOR deck is available only as a special order.

Galvanized with Primer

Galvanized FORMLOK deck is available with factory gray or white primer applied to the bottom (exposed) side of the deck for applications where the deck will be field-painted (eliminates the need for field priming) or must meet other specific requirements. Fire ratings with spray applied fireproofing are not applicable for galvanized decks with primer painted underside.

Exposed Product Appearance

FORMLOK deck and cellular FORMLOK deck are structural products. Minor dents and scratches which do not affect the structural capacity of deck are not grounds for rejection. Note that lighter gage material is more susceptible to the appearance of oil canning and minor dents during the shipping, handling and installation process. For cellular FORMLOK deck, flat bottom pans are susceptible to the appearance of oil-canning, particularly when perforated. The appearance of oil canning does not affect the structural integrity of fluted and cellular FORMLOK decks and is not grounds for rejection.

FLOOR DECK DURING CONSTRUCTION



The maximum spans of FORMLOK and VERCOR deck without shoring shown in the tables on pages 40–139 are based on the dead weight of concrete and deck plus the more critical of either a 20 psf construction live load or a 150 lb concentrated load which simulates the effects of a worker standing on the deck. If these loads are exceeded, there may be excessive deflection and/or buckling of the web and top flange, resulting in subsequent deck failure.

Spans

Span length is one of the key factors in determining an appropriate deck profile. Determine logical span multiples (3 span minimum if possible) based on the bay size. The maximum length for FORMLOK or VERCOR deck is 40 ft. Contact your Vercor representative regarding the availability of deck if lengths between 40 ft and 45 ft are required. The maximum length for cellular FORMLOK deck is 32 ft. Handling the deck during installation should also be considered when evaluating long deck lengths, especially in heavier gages.

Table 3: FORMLOK Deck Span Suggestions

Span Length	Deck Type
≤ 8 ft	PLB or B FORMLOK
7–10 ft	PLW2 or W2 FORMLOK
9–15 ft	PLW3 or W3 FORMLOK

Gage Selection

FORMLOK deck gage is normally selected by determining the lightest gage which meets the superimposed load requirements and which is in the unshaded, and therefore unshored, area of the tables. Unshored construction is usually more economical. When selecting FORMLOK deck gages, also consider the following:

- 20 gage minimum is recommended for multi-story construction since FORMLOK deck is used extensively for storage and as a working platform. Note that construction loads must not exceed the carrying capacity of the deck.
- Availability of 21 and 19 gage PLW2, W2, PLW3, or W3 FORMLOK deck should be checked if quick delivery is required or the quantity of FORMLOK deck is less than approximately 22,500 ft².

Concrete Placement



FORMLOK or VERCOR deck may be overloaded by the method used to place the concrete or by excessive deflection of beams or girders that are not shored or cambered. **Place concrete first over beams and girders rather than at mid-span. Do not pile it higher than the finished depth of the slab.** If overloading is anticipated, either select a heavier gage or shore deck during the placement and curing of concrete.

Note: Calcium chloride and concrete admixtures containing chloride salts can cause deck corrosion and shall not be used on steel deck.

Bearing

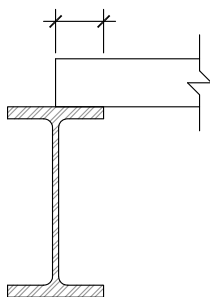

Verco recommends 2 in. minimum bearing length for FORMLOK and VERCOR deck. The required bearing length should be verified based on specific project conditions. Adequate bearing length is required to prevent web crippling of the deck during concrete placement and to allow for proper attachment of the deck. The allowable reactions shown in the tables are normally compared to the reactions due to dead load of the slab plus a 20 psf uniform construction live load. Allowable reactions are applicable to FORMLOK deck before the concrete has acquired minimum compressive strength. Adequate bearing length at parallel supports should be provided to make the specified connections.

Note: The maximum unshored clear span on pages 40–139 assume allowable reactions that correspond to the bearing length listed in table footnotes. Project conditions where these assumptions are not valid require further evaluation and may result in reduced maximum unshored clear spans.

Design Criteria for Deck-as-a-Form

The following design criteria and formulas were used to calculate the maximum spans of FORMLOK and VERCOR deck without shoring. Loading combinations utilized are illustrated in Figure 9 for clarity.

- w_{dl} is the dead load of concrete plus deck plus deflection allowance.
- The following allowances for ponding due to deck deflection between support members are included in w_{dl} :
 - 3 psf for light weight concrete,
 - 4 psf for normal weight concrete.
- No allowance is included for deflection of structural supports.
- w_{ll} is 20 psf uniform construction live load.
- P is 150 pound concentrated construction live load.
- L is span length in feet. Span lengths shown in the tables are clear spans.
- ASD allowable moment, $M = M_n / \Omega_b$, where:
 - $\Omega_b = 1.67$
 - $M_n = F_y \cdot S_{eff}$ (+ or -), where:
 - $F_y = 50$ ksi (all FORMLOK decks)
 - $F_y = 60$ ksi (all VERCOR decks)
 - S_{eff} (+ or -) = Effective section modulus
- Deck deflection is limited to the lesser of $L/180$ or $\frac{3}{4}$ in.
- The tables assume allowable reactions based on the maximum bearing length permitted by AISI S100. Specific project conditions should be evaluated.

Design Formulas

+M = Positive Bending Moment in ft-lb
-M = Negative Bending Moment in ft-lb
 Δ = Deflection in inches
E = 29,500,000 psi
 R_e = End reaction in lb/ft
 R_i = Interior reaction in lb/ft

Single Span

Stress

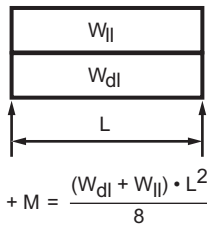
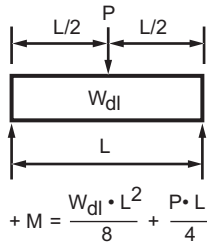

Deflection

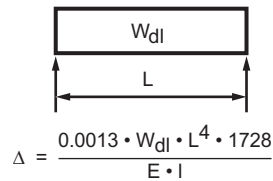

Reactions

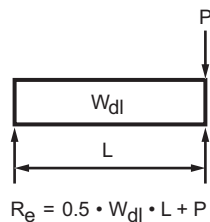
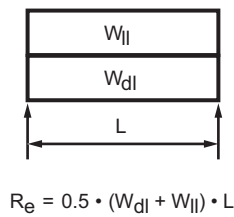

Double Span

Stress

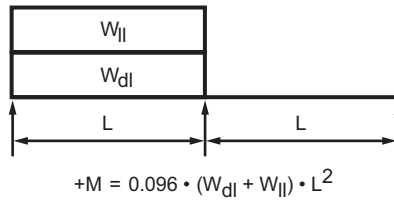
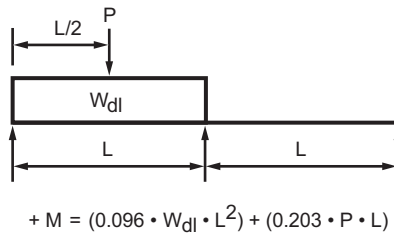
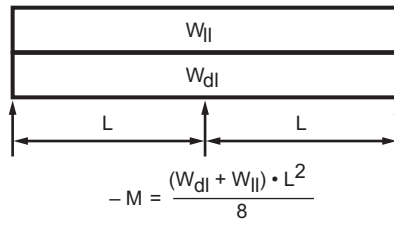

Deflection

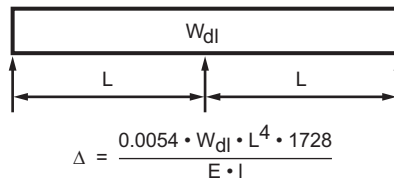

Reactions

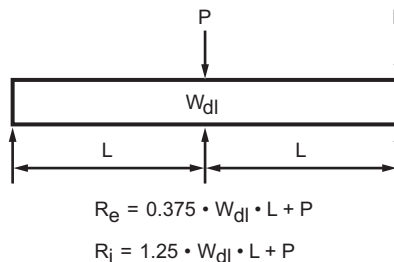
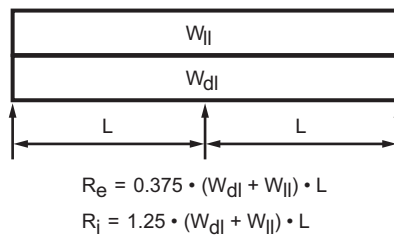

Triple Span

Stress

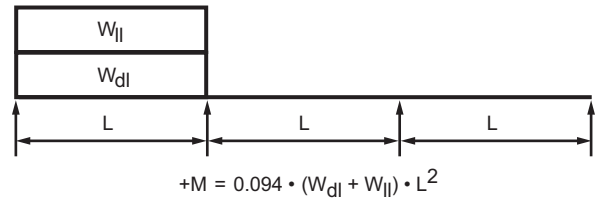
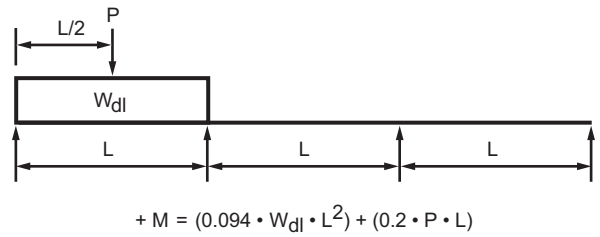
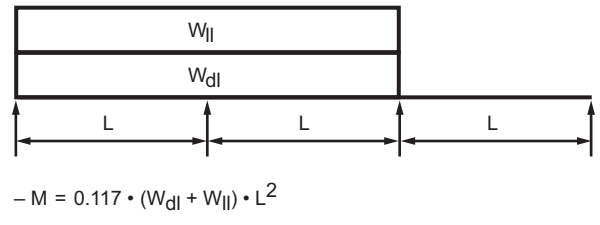

Deflection

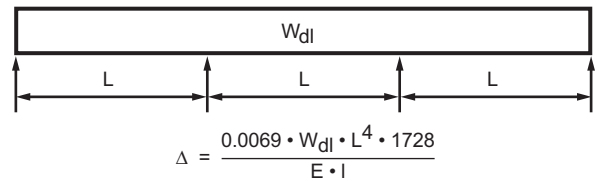

Reactions

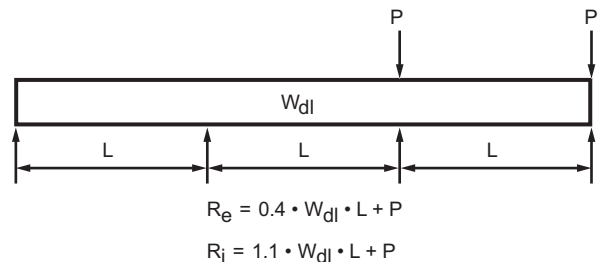
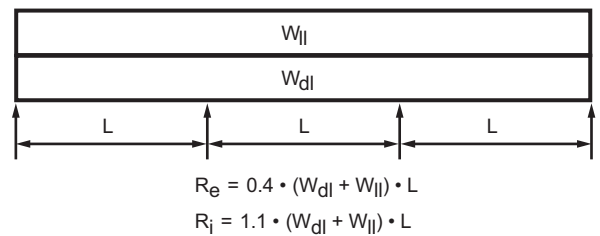

FIGURE 9

FORMLOK COMPOSITE SLAB DESIGN EXAMPLE

This is a simple design example to illustrate the steps involved in the proper selection of FORMLOK deck. Various options are outlined for each point to be considered. *This example illustrates the steps, not all possible selection options.*

Design Goals

The design goals for this example are as follows:

- Minimize dead load
- Eliminate temporary shoring

Given: 30' x 40' bay size

2-hour fire rated floor required

Underside of slab not exposed to view

Loads:

Live load	100 psf
Partition	20 psf
Mechanical	5 psf
Total Superimposed Load	125 psf

Span Options

Spacing between beams determines the deck profile options. Refer to “Spans” on page 14 for more information.

Assume 6" wide framing members regardless of span used.

1. 13'-4" c-c span, 12'-10" clear span, 3 span condition.
Choice: PLW3 (or W3) FORMLOK - may require shoring based on concrete type and thickness chosen.
2. 10'-0" c-c span, 9'-6" clear span, 4 span condition.
Choices: PLW2 (or W2) FORMLOK **or** PLW3 (or W3) FORMLOK
3. 8'-0" c-c span, 7'-6" clear span, 5 span condition.
Choices: PLB (or B) FORMLOK **or** PLW2 (or W2) FORMLOK

—▶ **Select:** Option 1 reduces the required framing, but may require shoring based on concrete selection. Options 2 and 3 offer reduced deck costs and eliminate any shoring requirements.

Concrete Type & Fire Rating Options

Use availability and relative cost of structural light weight (LW) versus normal weight (NW) concrete to determine the appropriate option. Refer to “Fire-Rated Composite Slabs” on page 8 and Table 9 on pages 32–33 for more information.

1. 4½" NW concrete over deck – without fireproofing.
2. 3¼" LW concrete over deck – without fireproofing.
3. 2½" concrete over deck (NW or LW) – with fireproofing.

—▶ **Select:** Option 2 based on reduced weight and no fireproofing of deck required.

FORMLOK COMPOSITE SLAB DESIGN EXAMPLE (CONTINUED)

FORMLOK Deck Options Select FORMLOK profile and gage such that shoring is not required. Verify that adequate bearing is provided.

Option	Clear Span	FORMLOK Deck Profile	LW Concrete Total Slab Depth (in.)	Shoring Required?	Allowable Super-imposed Load (psf)	Total Slab Weight ¹ (psf)	Number of Spans	FORMLOK Deck Bearing	
								End 2"	Interior 6"
1	13'-0" ²	PLW3-19 ga ³	6¼	NO	184	49.2	3	OK	OK
2	13'-0" ²	PLW3-18 ga	6¼	NO	203	49.4	3	OK	OK
3	9'-6"	PLW2-20 ga	5¼	NO	258	44.1	4	OK	OK
4	9'-6"	PLW3-20 ga	6¼	NO	275	48.8	4	OK	OK
5	7'-6"	PLB-22 ga	4¾	NO	255	39.6	5	OK	OK

1. Total slab weight = concrete + deck deflection allowance + FORMLOK deck (galvanized deck assumed).

2. Use 13'-0" span length for comparison.

3. Verify availability of 19 gage based on project delivery requirements.

➔ **Select:** Selection should be based on framing layout. Options 1 and 2 minimize the number of framing members. Choose between Options 3 and 4 based on assembly weight vs. slab stiffness. Utilizing the PunchLok II system with any choice gives the optimal combination of strength and installed cost.

Note: When selecting longer spans, investigations of slab stiffness and project serviceability requirements may be warranted. See “Composite Slab Floor Vibrations” on page 7 for further information.

FORMLOK Finish Options

FORMLOK finish options should be discussed with your Verco representative. Based on a typical installation with the deck exposed only to an interior environment, phosphatized/painted deck may offer an economical FORMLOK option. Phosphatized/painted deck may also yield labor savings due to easier steel headed stud anchor welding.

Refer to “Verco Floor Deck Finishes” on page 13 for more information.

Specific Considerations

Determine whether factory-punched vent tabs should be specified in the FORMLOK deck. Specify attachment of the FORMLOK deck to supports as necessary to meet diaphragm requirements.

Refer to “Venting Floor Deck” on page 8 and “Attachment of Floor Deck” on page 10.

CONCRETE VOLUMES AND WEIGHTS

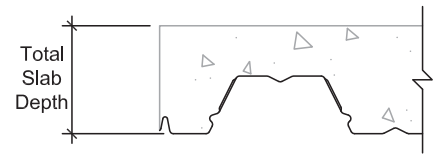

Table 4

Deck Type	Item	Units	Total Slab Depth								
			2½"	3"	3½"	4"	4½"	4¾"	5"	5¼"	
Flat Slab	Volume	yd ³ /100 ft ²	0.772	0.926	1.080	1.235	1.389	1.466	1.543	1.620	
	Weight	NW	psf	30.2	36.3	42.3	48.3	54.4	57.4	60.4	63.4
		LW	psf	22.9	27.5	32.1	36.7	41.3	43.5	45.8	48.1
Shallow VERCOR	Volume	yd ³ /100 ft ²	0.685	0.839	0.993	1.148	1.302	1.379	1.456	1.534	
	Weight	NW	psf	26.8	32.9	38.9	44.9	51.0	54.0	57.0	60.0
		LW	psf	20.3	24.9	29.5	34.1	38.7	41.0	43.3	45.5
Deep VERCOR	Volume	yd ³ /100 ft ²			0.878	1.032	1.186	1.264	1.341	1.418	
	Weight	NW	psf			34.4	40.4	46.4	49.5	52.5	55.5
		LW	psf			26.1	30.7	35.2	37.5	39.8	42.1
PLB B PLB-CD BCD	Volume	yd ³ /100 ft ²			0.781	0.936	1.090	1.167	1.244	1.321	
	Weight	NW	psf			30.6	36.6	42.7	45.7	48.7	51.7
		LW	psf			23.2	27.8	32.4	34.7	37.0	39.2
PLW2 W2 PLW2-CD W2CD	Volume	yd ³ /100 ft ²				0.926	1.080	1.157	1.235	1.312	
	Weight	NW	psf				36.3	42.3	45.3	48.3	51.4
		LW	psf				27.5	32.1	34.4	36.7	39.0
PLW3 W3 PLW3-CD W3CD	Volume	yd ³ /100 ft ²							1.080	1.157	
	Weight	NW	psf						42.3	45.3	
		LW	psf						32.1	34.4	
PLN3 N3 PLN3-CD N3CD	Volume	yd ³ /100 ft ²							0.979	1.056	
	Weight	NW	psf						38.3	41.3	
		LW	psf						29.1	31.4	
PLN N PLN-CD NCD	Volume	yd ³ /100 ft ²							0.878	0.955	
	Weight	NW	psf						34.4	37.4	
		LW	psf						26.1	28.4	

Notes:
(continued
next page)

- Volumes and weights do not include allowance for deflection.
- Weights are for concrete only and do not include weight of steel deck.
- Density of NW concrete is considered 145 pcf for chart above.
- Density of LW concrete is considered 110 pcf for chart above.
- Volume in table is cubic yards per 100 square feet.
- Weight given is pounds per square foot.

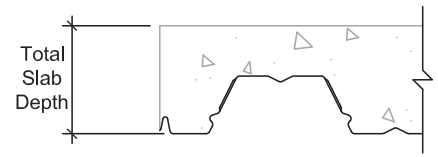

Table 4 (continued)

Deck Type	Item	Units	Total Slab Depth								
			5½"	5¾"	6"	6¼"	6½"	7"	7¼"	7½"	
Flat Slab	Volume	yd ³ /100 ft ²	1.698	1.775	1.852	1.929	2.006	2.160	2.238	2.315	
	Weight	NW	psf	66.5	69.5	72.5	75.5	78.5	84.6	87.6	90.6
		LW	psf	50.4	52.7	55.0	57.3	59.6	64.2	66.5	68.8
Shallow VERCOR	Volume	yd ³ /100 ft ²	1.611	1.688	1.765	1.842	1.919	2.074	2.151	2.228	
	Weight	NW	psf	63.1	66.1	69.1	72.1	75.1	81.2	84.2	87.2
		LW	psf	47.8	50.1	52.4	54.7	57.0	61.6	63.9	66.2
Deep VERCOR	Volume	yd ³ /100 ft ²	1.495	1.572	1.649	1.726	1.804	1.958	2.035	2.112	
	Weight	NW	psf	58.5	61.5	64.6	67.6	70.6	76.7	79.7	82.7
		LW	psf	44.4	46.7	49.0	51.3	53.6	58.2	60.4	62.7
PLB B PLB-CD BCD	Volume	yd ³ /100 ft ²	1.399	1.476	1.553	1.630	1.707	1.861	1.939	2.016	
	Weight	NW	psf	54.8	57.8	60.8	63.8	66.8	72.9	75.9	78.9
		LW	psf	41.5	43.8	46.1	48.4	50.7	55.3	57.6	59.9
PLW2 W2 PLW2-CD W2CD	Volume	yd ³ /100 ft ²	1.389	1.466	1.543	1.620	1.698	1.852	1.929	2.006	
	Weight	NW	psf	54.4	57.4	60.4	63.4	66.5	72.5	75.5	78.5
		LW	psf	41.3	43.5	45.8	48.1	50.4	55.0	57.3	59.6
PLW3 W3 PLW3-CD W3CD	Volume	yd ³ /100 ft ²	1.235	1.312	1.389	1.466	1.543	1.698	1.775	1.852	
	Weight	NW	psf	48.3	51.4	54.4	57.4	60.4	66.5	69.5	72.5
		LW	psf	36.7	39.0	41.3	43.5	45.8	50.4	52.7	55.0
PLN3 N3 PLN3-CD N3CD	Volume	yd ³ /100 ft ²	1.133	1.210	1.288	1.365	1.442	1.596	1.673	1.751	
	Weight	NW	psf	44.4	47.4	50.4	53.4	56.5	62.5	65.5	68.5
		LW	psf	33.7	36.0	38.2	40.5	42.8	47.4	49.7	52.0
PLN N PLN-CD NCD	Volume	yd ³ /100 ft ²	1.032	1.109	1.186	1.264	1.341	1.495	1.572	1.649	
	Weight	NW	psf	40.4	43.4	46.4	49.5	52.5	58.5	61.5	64.6
		LW	psf	30.7	32.9	35.2	37.5	39.8	44.4	46.7	49.0

Notes:
(continued
from page 20)

- PLB-CD, BCD, PLW2-CD, W2CD, PLW3-CD, W3CD, PLN3-CD, N3CD, PLN-CD, and NCD refer to cellular FORMLOK. Refer to page 109 for additional information.
- To calculate volumes or weights if slab is thicker than listed in table: Combine volumes or weights from the maximum total slab depth for the specified profile with those of a flat slab to equal the desired total slab depth. For example, to determine the weight of a 12" total slab depth using PLW3 and NW concrete, combine weights of a 7½" slab depth for PLW3 (72.5 psf) with a 4½" flat slab (54.4 psf) for a total weight of 126.9 psf.

DIAPHRAGMS WITH STEEL HEADED STUD ANCHORS

Table 5: Allowable Diaphragm Shear Strengths (plf) and Flexibility Factors (in./lbx10⁶) for Decks with Concrete Fill and ¾" Diameter Steel Headed Stud Anchors ^{1-8, 11, 16, 17, 19}

Concrete Type ⁹	Concrete Thickness ¹⁰	Spacing of Steel Headed Stud Anchors ¹⁴							F ¹²
		12"	16"	18"	24"	30"	32"	36"	
Minimum Concrete Reinforcement of 0.0025 Times the Area of Fill Above the Deck									
NW	2" ¹⁸	3110	3110	3110	3110	2980	2790	2480	0.40
	2½"	3890	3890	3890	3720	2980	2790	2480	0.32
	3"	4670	4670	4670	3720	2980	2790	2480	0.26
	3½"	5450	5450	4970	3720	2980	2790	2480	0.23
	4½"	7000	5590	4970	3720	2980	2790	2480	0.18
	6"	7450	5590	4970	3720	2980	2790	2480	0.13
LW	2" ¹⁸	2910	2910	2910	2910	2910	2770	2460	0.56
	2½"	3640	3640	3640	3640	2960	2770	2460	0.45
	3¼"	4740	4740	4740	3700	2960	2770	2460	0.35
	4¼"	6190	5550	4930	3700	2960	2770	2460	0.26
	6"	7400	5550	4930	3700	2960	2770	2460	0.19
Minimum Concrete Reinforcement of 0.00075 Times the Area of Fill Above the Deck¹³									
NW	2" ¹⁸	1310	1310	1310	1310	1310	1310	1310	0.40
	2½"	1640	1640	1640	1640	1640	1640	1640	0.32
	3"	1970	1970	1970	1970	1970	1970	1970	0.26
	3½"	2300	2300	2300	2300	2300	2300	2300	0.23
	4½"	2950	2950	2950	2950	2950	2790	2480	0.18
	6"	3940	3940	3940	3720	2980	2790	2480	0.13
LW	2" ¹⁸	1110	1110	1110	1110	1110	1110	1110	0.56
	2½"	1390	1390	1390	1390	1390	1390	1390	0.45
	3¼"	1810	1810	1810	1810	1810	1810	1810	0.35
	4¼"	2370	2370	2370	2370	2370	2370	2370	0.26
	6"	3350	3350	3350	3350	2960	2770	2460	0.19

1. The allowable diaphragm shear strengths are based on concrete slab reinforcement with a minimum area as stated in the following table. Reinforcement shall have an equivalent area and spacing in both directions. Welded wire fabric of the sizes listed in the following table meet this requirement. The reinforcement is placed approximately 1" below the top of the concrete.

(Table 5 Note 1 continued on following page)

Table 5 Note 1 (continued from preceding page)

Minimum Reinforcement for Tabulated Shear Strengths

Concrete Thickness ¹⁰	Reinforcement = 0.0025 Times Area of Fill Above the Deck		Reinforcement = 0.00075 Times Area of Fill Above the Deck	
	Area of Steel (in. ² /ft)	Suggested Fabric ¹⁵	Area of Steel (in. ² /ft)	Suggested Fabric ¹⁵
2"	0.060	4 x 4 - W2.0 x W2.0	0.028	6 x 6 - W1.4 x W1.4
2½"	0.075	4 x 4 - W2.5 x W2.5	0.028	6 x 6 - W1.4 x W1.4
3"	0.090	6 x 6 - W4.5 x W4.5	0.028	6 x 6 - W1.4 x W1.4
3¼"	0.098	6 x 6 - W5.0 x W5.0	0.029	6 x 6 - W2.0 x W2.0
3½"	0.105	4 x 4 - W3.5 x W3.5	0.032	6 x 6 - W2.0 x W2.0
4¼"	0.128	6 x 6 - W6.5 x W6.5	0.038	6 x 6 - W2.0 x W2.0
4½"	0.135	4 x 4 - W4.5 x W4.5	0.041	4 x 4 - W1.4 x W1.4
6"	0.180	4 x 4 - W6.0 x W6.0	0.054	6 x 6 - W2.9 x W2.9

- Steel headed stud anchor diameter must be less than or equal to 2.5 times the steel support thickness unless stud anchor is located directly over the support web.
- See Figure 10 for details.
- Allowable diaphragm shear strengths assume "weak stud position" as shown in Figure 12 with a single stud anchor per rib at the spacing shown in the tables. The allowable diaphragm shear strengths may be used when the deck is either perpendicular or parallel to the supports.
- For local shear transfer within the field of the diaphragm, ¾" diaphragm steel headed stud anchors having an allowable shear strength of 7.46 kips per stud for normal weight concrete fills and 7.40 kips per stud for structural light weight concrete shall be used. However, when using Deep VERCOR, ½" diameter stud anchors having an allowable shear value of 3.31 kips per stud anchor for normal weight concrete and 3.29 kips per stud for light weight concrete shall be used.
- Sidelap connections shall be spaced at 36" on center maximum with either button punch, No. 10 screw, 1½" long top seam weld (standing seams), or 1½" long fillet weld (nested seams) used with the appropriate profile. Sidelaps of PLB, PLW2, PLW3, and PLN shall be connected with Verco Sidelap Connection (VSC2) at 36" on center maximum.
- To obtain factored (LRFD) diaphragm shear strengths, the tabulated strengths may be multiplied by a factor of 1.5 for all load combinations.
- See ACI 318, Section 9.3.4 for possible reductions of the diaphragm shear strength dependent on the vertical components of the primary lateral-force-resisting system. Tabulated values may be multiplied by $\phi/0.75$, where ϕ is modified in accordance with ACI 318, Section 9.3.4.
- Design compressive strength of concrete $f'_c = 3000$ psi minimum.
NW = Normal weight concrete (145 pcf); LW = Structural light weight concrete (110 pcf).
- Concrete thickness (t_f) is measured above top flute of steel deck.
- FORMLOK deck types PLB, B, PLBCD, BCD, BR, PLW2, W2, PLW2-CD, W2CD, PLW3, W3, PLW3-CD, W3CD, PLN3, N3, PLN3-CD, N3CD, PLN, N, PLN-CD, and NCD shall use a minimum ¾" diameter steel headed stud anchors to achieve the tabulated strengths. Deep VERCOR (1⅝" deep) shall use ½" diameter steel headed stud anchors. The tabulated strengths shall be multiplied by a factor of 0.44 for Deep VERCOR.
- The flexibility factor (F) is the number of microinches a diaphragm web will deflect in a span of 1 foot under a shear load of 1 pound per foot.
- Also compare tabulated strengths to the allowable diaphragm strength for FORMLOK decks with concrete shown on pages 40–108.
- The maximum center-to-center spacing of steel headed stud anchors shall not exceed either 8 times the total slab thickness or 36".
- Minimum lap of welded wire fabric shall be 12".
- Steel decks shall be fastened to intermediate deck supports with arc spot welds or mechanical fasteners.
- Steel headed stud anchors shall extend not less than 1½" above top of steel deck and shall have at least ½" concrete cover. Minimum stud lengths for each deck profile are given in Figure 10.
- Tabulated shear strengths for slabs with 2" concrete cover thickness are not applicable to Deep VERCOR deck unless steel headed stud anchors meeting the requirements of footnote 17 are used.
- All FORMLOK and Deep VERCOR steel deck profiles have an average rib width, w_r , of not less than 2" as required in AISC Specification Section I3.2.

Steel Headed Stud Anchors at Supports Parallel to Flutes

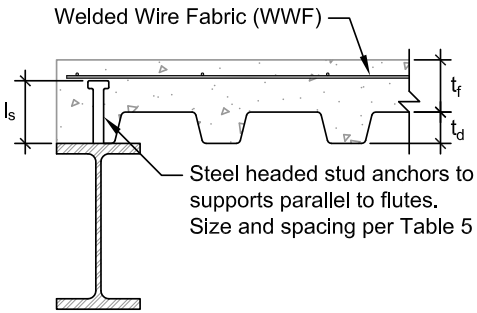

Typical Exterior or Interior Steel Headed Stud Anchors

Deck Height (t_d)	Stud Length* (l_s)
1 $\frac{5}{16}$ "	3"
1 $\frac{1}{2}$ "	3"
2"	3 $\frac{1}{2}$ "
3"	4 $\frac{1}{2}$ "

* Minimum finished length

Steel Headed Stud Anchors at Supports Perpendicular to Flutes

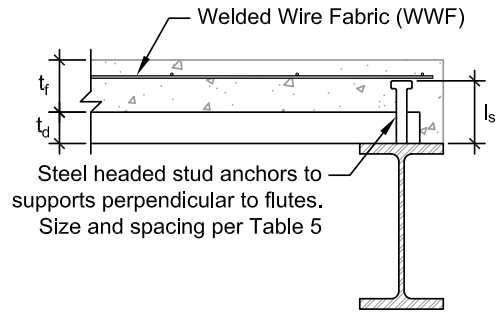
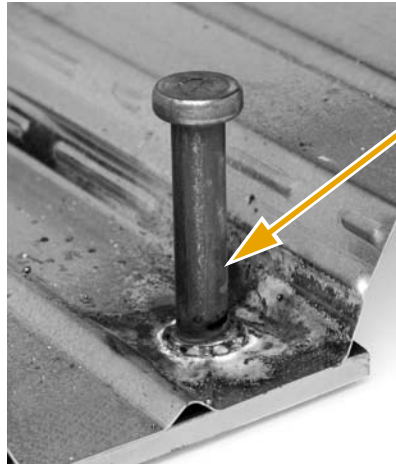

FIGURE 10



Steel Headed Stud Anchors

FIGURE 11

STEEL HEADED STUD ANCHORS

Table 6: Allowable Shear Strength (kips) per 3/4" Diameter Steel Headed Stud Anchor with FORMLOK Deck

Deck Condition		Normal Weight Concrete (145 pcf)		Light Weight Concrete (110 pcf)		
		f' _c = 3 ksi	f' _c = 4 ksi	f' _c = 3 ksi	f' _c = 4 ksi	
No Deck (Solid Concrete)		9.11	9.32	7.40	9.19	
Deck Parallel	w _r /h _r ≥ 1.5	9.11	9.32	7.40	9.19	
	w _r /h _r < 1.5	7.92	7.92	7.40	7.92	
Deck Perpendicular	Weak Studs per Rib	1	7.46	7.46	7.40	7.46
		2	6.34	6.34	6.34	6.34
		3	5.22	5.22	5.22	5.22
	Strong Studs per Rib	1	9.11	9.32	7.40	9.19
		2	7.92	7.92	7.40	7.92
		3	6.53	6.53	6.53	6.53

Notes:

- Values in Table 6 are based on the AISC 360-10 Specification Table 3-21 and Section I8.2a "Strength of Steel Headed Stud Anchors".
- For Deep Vercor, strengths in Table 6 shall be modified by a factor of 0.44 for both parallel and perpendicular conditions, using a 1/2" diameter stud.
- w_r/h_r ≥ 1.5 for PLW2 and W2 FORMLOK, PLW3 and W3 FORMLOK, and Deep VERCOR.
w_r/h_r < 1.5 for PLB and B FORMLOK, PLN3 and N3 FORMLOK, PLN and N FORMLOK.
- Strengths in Table 6 are applicable only to concrete made with ASTM C33 aggregate.
- w_r indicates average width of concrete rib or haunch (in.); h_r indicates nominal rib height (in.).
- Steel headed stud anchor lengths are assumed to be ≥ deck height + 1.5 in.
- An ASD safety factor of Ω = 2.31 was utilized to determine the allowable shear per steel headed stud anchor in Table 6.
- A "weak" stud is defined as a stud whose distance from the edge of the stud shank to the steel deck web, measured at mid-height of the deck and in the load-bearing direction of the stud, is < 2". For "strong" studs, this distance is ≥ 2". See detail at bottom of Figure 12 for weak and strong stud position.
- When using composite beams or girders, designers should consider adding reinforcing steel in the concrete fill over the metal deck in the effective width of the composite beam or girder.
- Designers should consider using partial composite design for possible reduction of the number of studs required.
- If openings will be cut in the slab adjacent to the composite beams or girder during the life of the building, consideration should be given to the design of the composite section.

STEEL HEADED STUD ANCHOR PLACEMENT AND DETAILS

Minimum Rib Widths for Full Value of Stud

All Deck Profiles

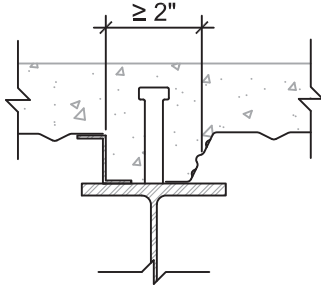

FORMLOK Deck Parallel to Girder

1 Row of Studs

2 Rows of Studs

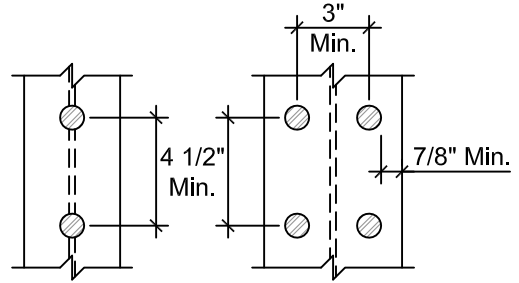

Suggested 3/4" Diameter Stud Placement and Minimum Flange Widths

1 Stud per Flute

(PLB and B FORMLOK, PLN3 and N3 FORMLOK, PLN and N FORMLOK)

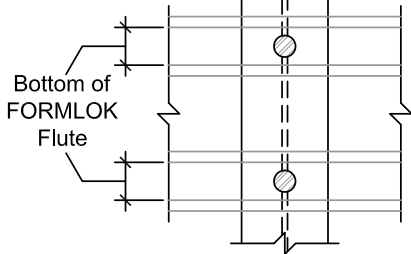
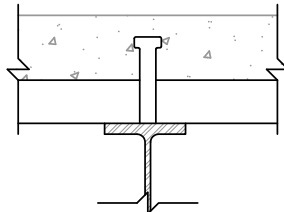

1 or 2 Studs per Flute

(PLW2, W2, PLW3, and W3 FORMLOK)

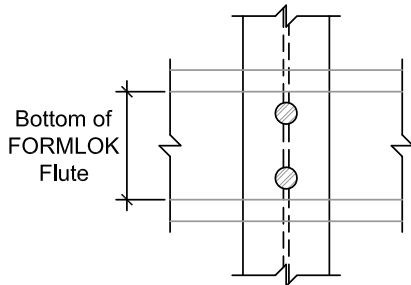

2 Studs per Flute

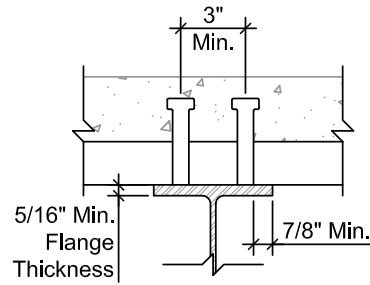

3 Studs per Flute

(PLW2, W2, PLW3, and W3 FORMLOK)

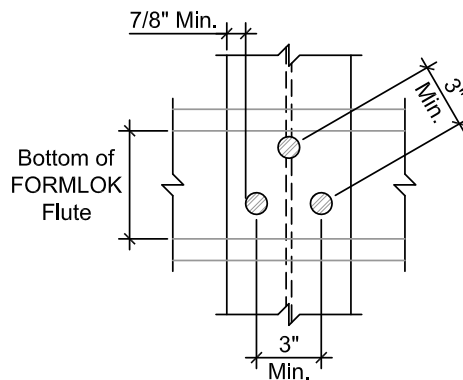
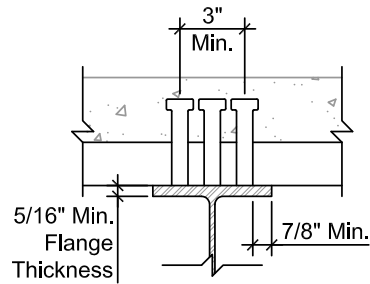

Strong Stud/Weak Stud Positions

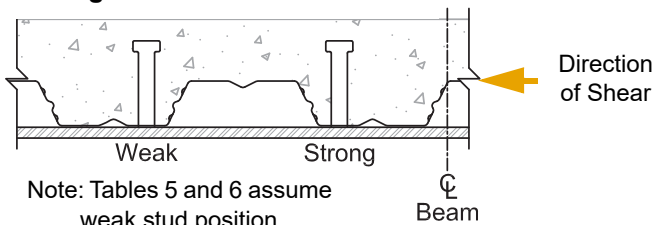

FIGURE 12

FORMLOK COMPOSITE SLAB—SUGGESTED DETAILS

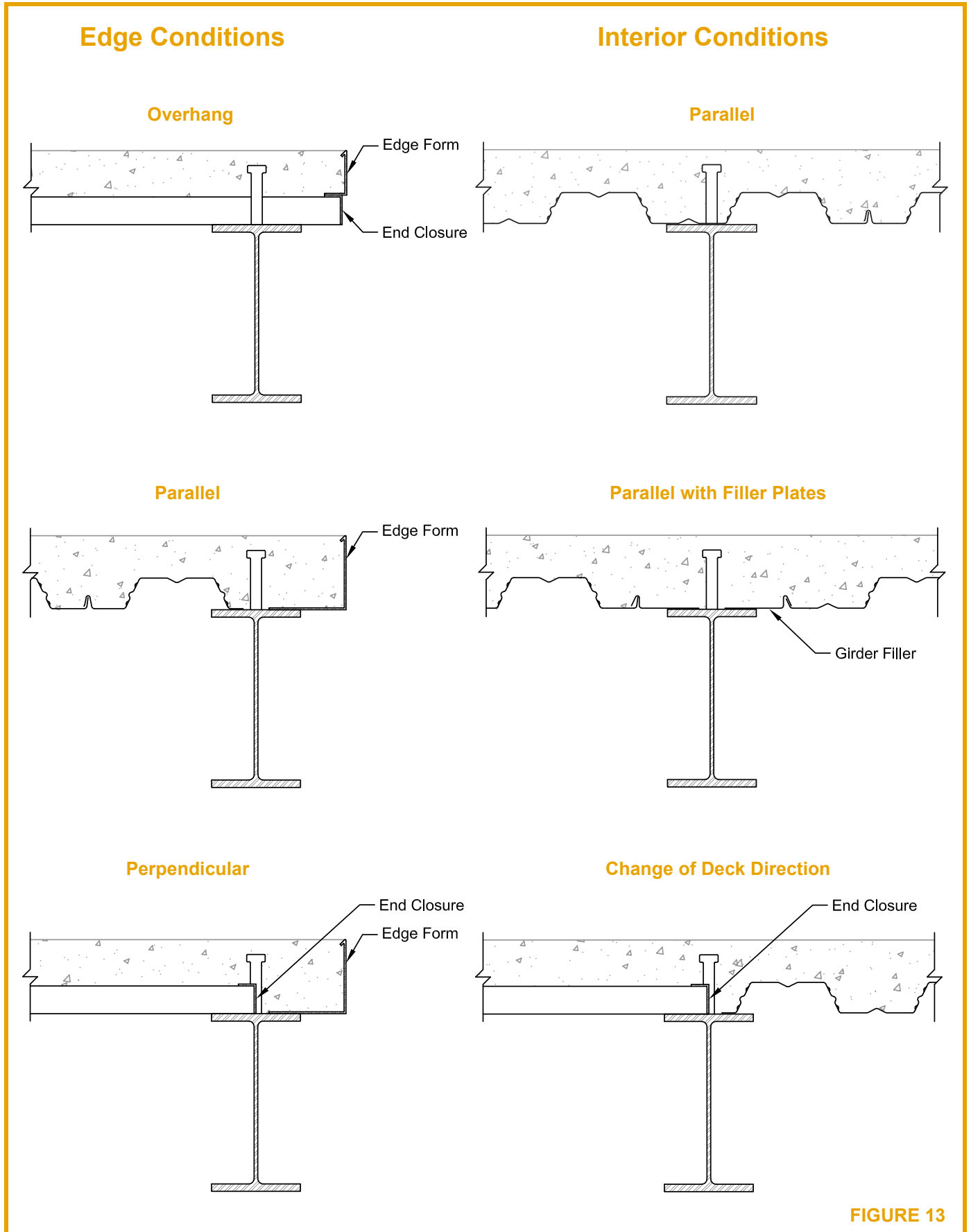
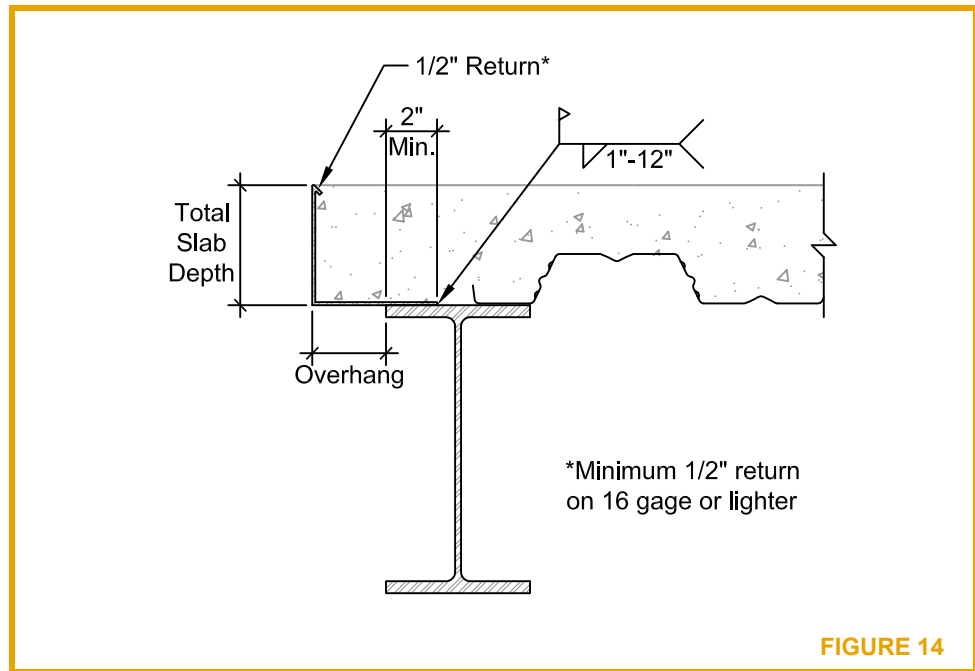

FIGURE 13

EDGE FORM SUGGESTIONS



The edge form gages shown in Table 7 are provided as suggestions, but do not preclude the use of different gages based on alternate criteria.

Table 7: Edge Form Gage Selection^{1, 3, 4}

Total Slab Depth ²	Overhang								
	2"	3"	4"	5"	6"	7"	8"	9"	10"
4"	18	18	16	14	12	12	12	10	10
4½"	18	18	16	14	12	12	12	10	10
5"	18	18	16	14	12	12	12	10	10
5½"	18	16	16	14	12	12	10	10	10
6"	18	16	14	14	12	12	10	10	
6½"	18	16	14	12	12	12	10	10	
7"	16	16	14	12	12	12	10	10	
7½"	16	14	14	12	12	10	10		

Notes:

1. Steel edge form minimum yield strength, $F_y = 33$ ksi.
2. Normal weight concrete (145 pcf).
3. 100 psf superimposed load on overhang.
4. For overhangs greater than those shown, additional support or bent plates suggested.

FLOOR DECK ACCESSORIES

Profile Closures

Profile closures made from steel or neoprene are designed to fit Verco's FORMLOK and VERCOR deck products. See Table 8 for availability of closures by deck profile. Steel closures are 22 gage with a 1 in. return lip for fastening to deck with screws or tack welds. Neoprene closures for FORMLOK decks are 1 in. thick individual plugs. Neoprene closures for VERCOR decks are 1 in. thick, 36 in. long strips. See Figure 15.

Table 8: Availability of Profile Closures

Deck Profile	Steel Closures		Neoprene Closures	
	Underside	Topside	Underside	Topside
PLB or B FORMLOK	✓	✓	✓	✓
PLW2 or W2 FORMLOK	✓	✓	✓	✓
PLW3 or W3 FORMLOK	✓	✓	✓	✓
PLN3 or N3 FORMLOK	✓		✓	✓
PLN or N FORMLOK	✓		✓	✓
Deep VERCOR			✓	✓
Shallow VERCOR			✓	✓

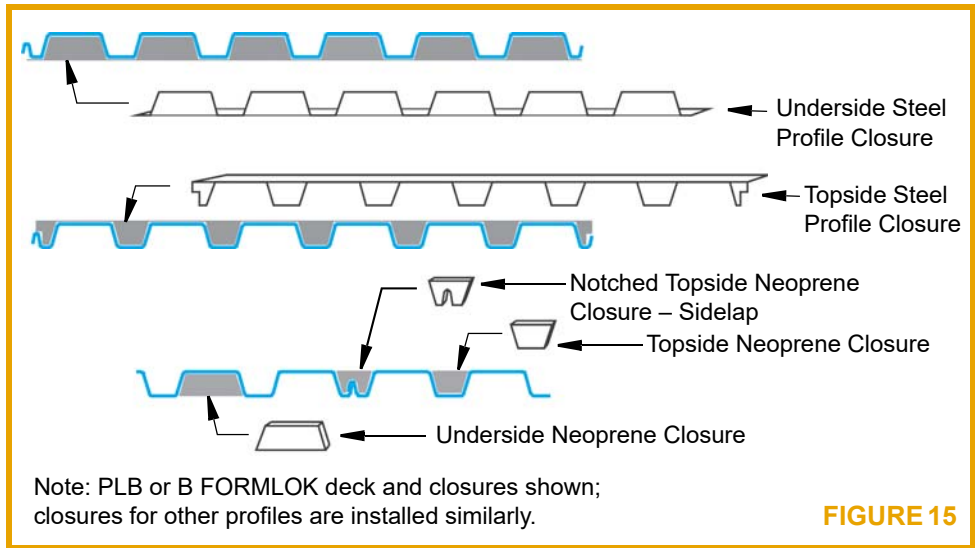

End Closures

20 gage steel end closures are available for all FORMLOK profiles. See Figure 16 for available sizes and Figure 13 for suggested details.

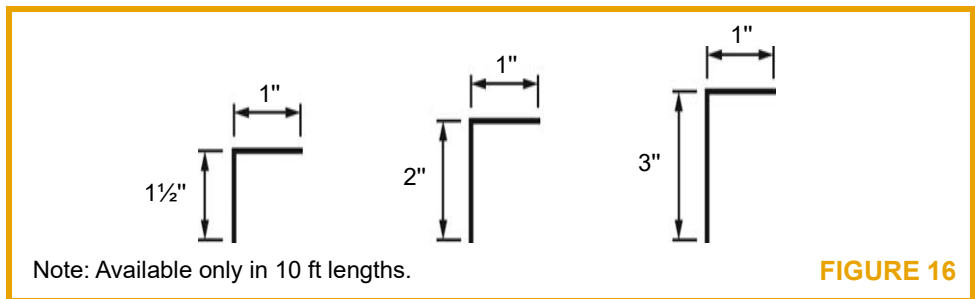

OPENINGS IN FORMLOK DECKS

The following suggestions for openings in FORMLOK deck are intended to address support of construction loads by the deck before the concrete has fully cured and to address distribution of the reactions from superimposed loads to the adjacent composite slab. These suggestions should be evaluated based on specific project conditions by the responsible design professional.

It is suggested in all cases that the openings should be blocked out and the FORMLOK deck left intact whenever possible. After the concrete has cured, the FORMLOK deck in the area of the opening can be removed. If the deck is left intact until after the concrete has fully cured, alternative methods of reinforcing to those illustrated, such as rebar, may be used to distribute superimposed loads around the opening.

Note: Typically, individual holes less than 6 in. in diameter and cutting no more than one web need no reinforcing.

(continued on page 31)

Holes cutting no more than:

- 3 adjacent webs for 6" and 8" module deck.
- 2 adjacent webs for 12" module deck.

This is considered a single opening.

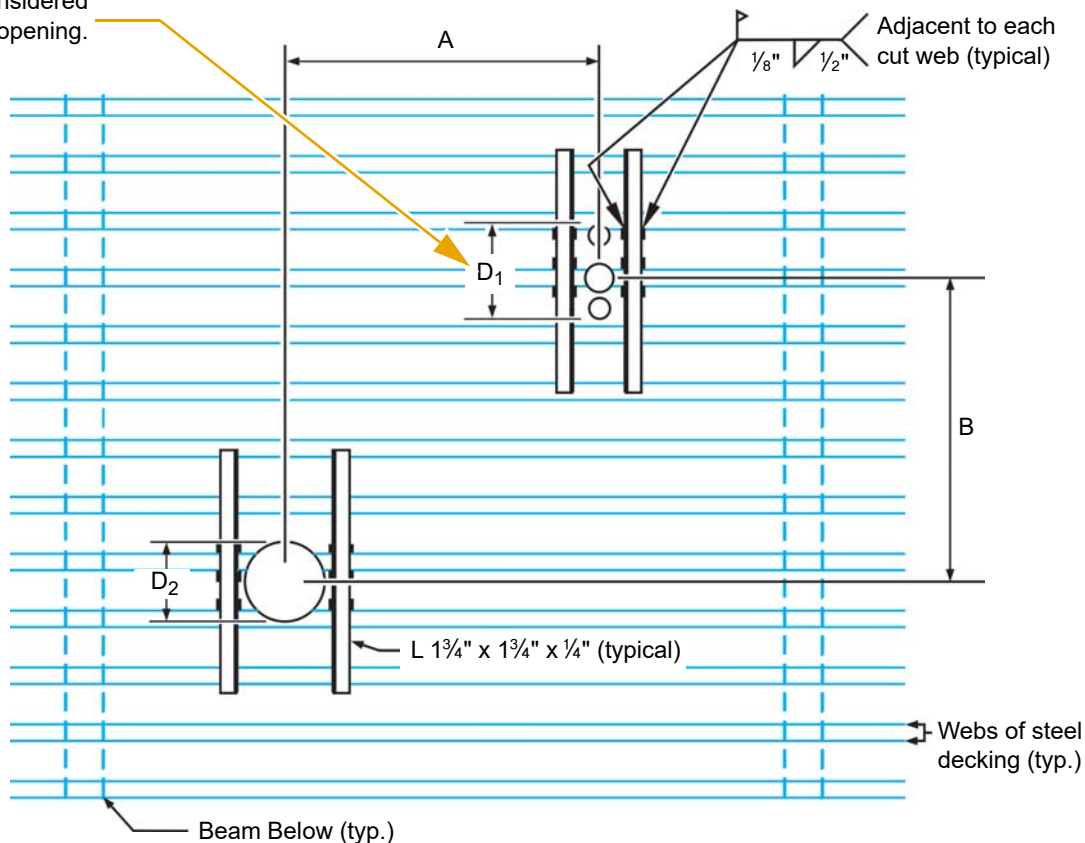

Notes:

1. Angles shall be placed on top of the FORMLOK deck.
2. Angles shall extend 3 webs past the deck opening (typical).
3. If Dimension A is $>4D_1$, $4D_2$, or 32" whichever is larger, there is no restriction on Dimension B.
4. If Dimension B is $>4D_1$, $4D_2$, or 32" whichever is larger, there is no restriction on Dimension A.
5. If Dimensions A and B are $<4D_1$, $4D_2$, or 32" whichever is larger, the opening group shall be considered as a single large hole, and shall be reinforced as required for the larger opening as shown in Figure 19.

FIGURE 18

(continued from page 30)

- The diagonal bars shown at larger openings are intended to address cracking at corners and are in addition to the reinforcing required for load distribution.
- Figure 18 illustrates recommendations for holes 6 to 12 in. in diameter, those cutting more than one web, or groups of small holes.
- Figure 19 illustrates recommendations for larger openings, up to 24".
- Provide alternate means of support around openings or groups of openings larger than 24 in.

The critical dimension for an opening or groups of openings is the width measured perpendicular to the deck span as shown in Figures 18 and 19. The length of an opening or hole measured parallel to the direction of the deck span is not limited.

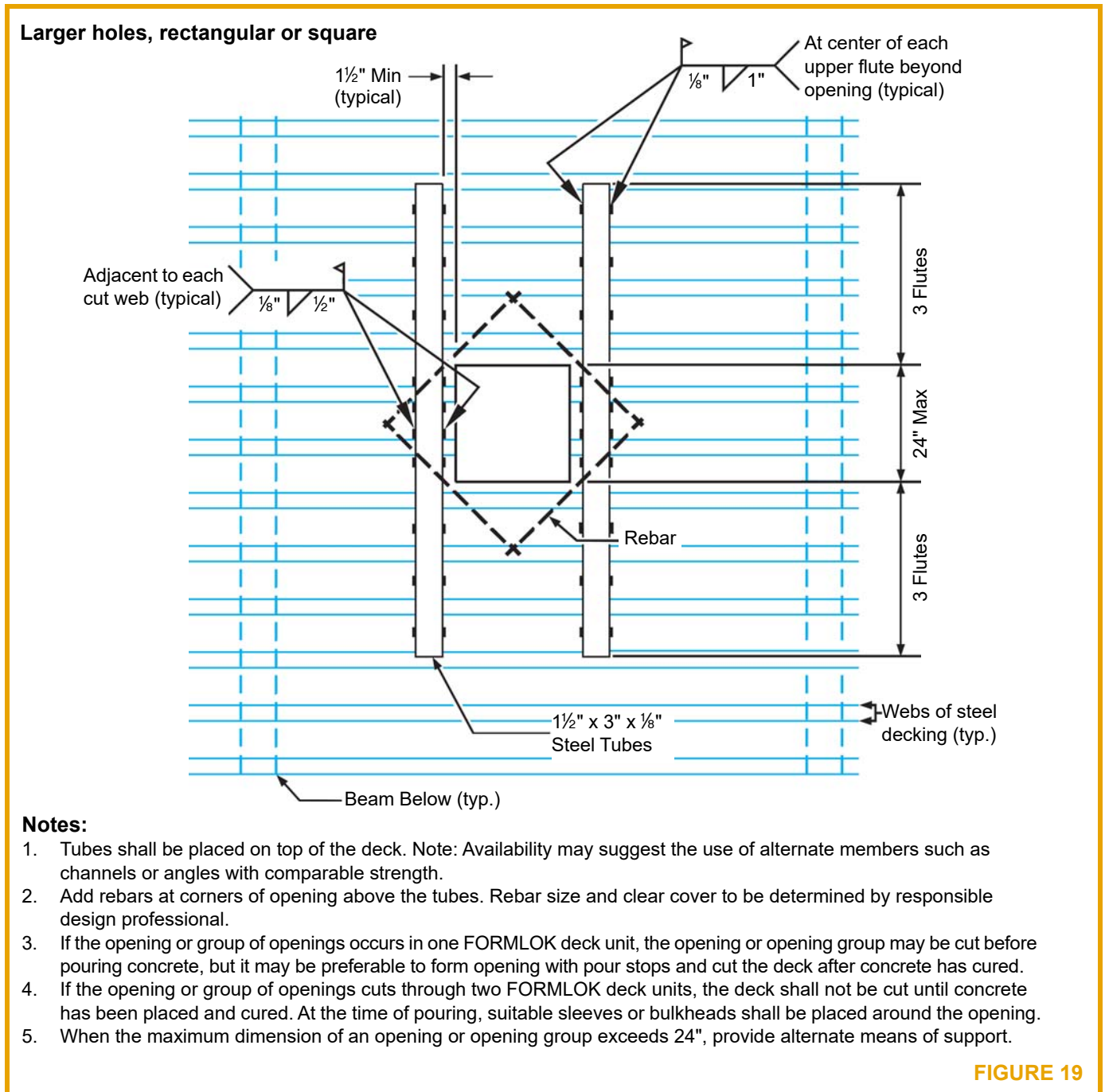

FORMLOK COMPOSITE SLAB FIRE RESISTANCE RATINGS

Table 9 2, 4, 6, 8, 9

RESTRAINED ASSEMBLY RATING (hr)	UL #	FRAME	CONCRETE (in.) ⁷	FORMLOK DECK ¹							PROTECTED ⁵
				B	BR	W2	W3	N3	N	DV	
1-3	D216	Beam/Joist	(varies) LW, NW	✓	✓	✓	✓	✓	✓		Gypsum
1-2	D303	Beam	(varies) LW, NW	✓	✓	✓	✓	✓	✓		Mineral/Fiber Board
1.5-2	D502	Beam/Joist	(varies) NW	✓	✓	✓	✓	✓	✓		Gypsum
1-4	D739	Beam/Joist	2½" LW, NW	✓	✓	✓	✓	✓	✓		SFRM
1-3	D743	Beam	2" LW, NW			✓	✓				SFRM
2	D750	Beam	2½" LW, NW	✓	✓	✓	✓	✓	✓		SFRM
2-3	D755	Beam/Joist	2½" LW, NW	✓	✓	✓	✓	✓	✓		SFRM
2-3	D759	Beam/Joist	2½" LW, NW	✓	✓	✓	✓	✓	✓		SFRM
2-4	D760	Beam/Joist	2½" LW, NW	✓	✓	✓	✓				SFRM
2	D764	Beam/Joist	2½" LW, NW	✓	✓	✓	✓	✓	✓		SFRM
1-4	D767	Beam/Joist	2½" LW, NW	✓	✓	✓	✓	✓	✓		SFRM
2	D775	Beam	2½" LW, NW	✓	✓	✓	✓	✓	✓		SFRM
1-4	D779	Beam/Joist	2½" LW, NW	✓	✓	✓	✓				SFRM
1-4	D787	Beam/Joist	2½" LW, NW	✓	✓	✓	✓	✓	✓		SFRM
1-4	D788	Beam/Joist	2½" LW, NW	✓	✓	✓	✓		✓		SFRM
2	D794	Beam/Joist	2½" LW, NW	✓	✓	✓	✓	✓	✓		SFRM
1-3	D795	Beam/Joist	2½" LW, NW	✓	✓	✓	✓	✓	✓		SFRM
1-4	D796	Beam/Joist	2½" LW, NW	✓	✓	✓	✓	✓	✓		SFRM
2	D826	Beam	¾" LW	✓	✓	✓	✓	✓	✓		SFRM
2-3	D832	Beam	2½" LW, NW	✓	✓	✓	✓	✓	✓		SFRM
2	D840	Beam	(varies) LW	✓	✓	✓	✓	✓	✓		SFRM
1-4	D858	Beam	2½" LW, NW	✓	✓	✓	✓	✓	✓		SFRM
1-3	D859	Beam	2" LW, NW	✓	✓	✓	✓	✓	✓		SFRM
3	D867	Beam	2½" LW, NW	✓	✓	✓	✓	✓	✓		SFRM
1-3	D871	Beam	2½" LW, NW			✓	✓				SFRM
1-3	D875	Beam	2" LW, NW	✓	✓	✓	✓	✓	✓		SFRM
2	D878	Beam	¾" LW	✓	✓	✓	✓	✓	✓		SFRM
1-3	D883	Beam	2½" LW, NW	✓	✓	✓	✓	✓	✓		SFRM
2	D888	Beam	(varies) LW	✓	✓	✓	✓	✓	✓		SFRM
1-4	D891	Beam	2½" LW, NW	✓	✓	✓	✓	✓	✓		SFRM
3	D896	Beam	(varies) LW, NW	✓	✓	✓	✓	✓	✓		SFRM
1-3	D898	Beam	2½" LW, NW			✓	✓				SFRM
1-3	D902	Beam/Joist	(varies) LW, NW	✓ ³	✓	✓ ³	✓ ³	✓ ³	✓ ³		No
2	D907	Beam	¾" LW	✓	✓	✓	✓	✓	✓		No
¾-1	D914	Beam	2½" LW	✓	✓	✓	✓	✓	✓		No
¾-3	D916	Beam/Joist	(varies) LW, NW	✓	✓	✓	✓	✓	✓		No
1-3	D919	Beam	(varies) LW, NW	✓	✓	✓	✓	✓	✓		No
2	D920	Beam	¾" LW			✓	✓				No
¾-3	D922	Beam/Joist	(varies) LW, NW	✓	✓	✓	✓	✓	✓		No
¾-3	D923	Beam	(varies) LW, NW	✓	✓	✓	✓	✓	✓		No
2-3	D924	Beam	(varies) LW, NW	✓		✓	✓				No

(continued on following page)

Table 9 (continued)

RESTRAINED ASSEMBLY RATING (hr)	UL #	FRAME	CONCRETE (in.) ⁷	FORMLOK DECK ¹							PROTECTED ⁵
				B	BR	W2	W3	N3	N	DV	
¾-3	D925	Beam/Joist	(varies) LW, NW	✓ ³	✓	✓ ³	✓ ³	✓ ³	✓ ³		No
¾-3	D927	Beam/Joist	(varies) LW, NW	✓	✓	✓	✓	✓	✓		No
1-3	D929	Beam	(varies) LW, NW	✓	✓	✓	✓	✓	✓		No
2	D931	Beam	(varies) LW, NW	✓	✓	✓	✓	✓	✓		No
1-3	D943	Beam/Joist	(varies) LW, NW	✓	✓	✓	✓	✓	✓		No
1-3	D949	Beam/Joist	(varies) LW, NW	✓	✓	✓	✓		✓		No
1-3	D957	Beam/Joist	(varies) LW, NW	✓ ³	✓	✓ ³	✓ ³	✓ ³	✓ ³		No
¾-3	D958	Beam/Joist	(varies) LW, NW	✓	✓	✓	✓	✓	✓		No
¾-1	D967	Beam	2½" LW	✓	✓	✓	✓	✓	✓		No
1-3	D968	Beam	(varies) LW, NW	✓	✓	✓	✓	✓	✓		No
2-3	D969	Beam	(varies) LW, NW	✓		✓	✓				No
2	D973	Beam	¾" NW			✓	✓				No
3	D974	Beam/Joist	4½" NW	✓ ³	✓	✓ ³	✓ ³	✓ ³	✓ ³		No
1-3	D975	Beam	(varies) LW, NW	✓ ³	✓	✓ ³	✓ ³	✓ ³	✓ ³		No
1-2	D976	Beam/Joist	¾" NW	✓ ³	✓	✓ ³	✓ ³	✓ ³	✓ ³		No
1-2	D977	Beam/Joist	¾" LW	✓ ³	✓	✓ ³	✓ ³	✓ ³	✓ ³		No
1.5-3	G213	Joist	(varies) NW	✓						✓	Acoustical Material
2	G222	Joist	2½" NW	✓						✓	Acoustical Material
2	G227	Beam/Joist	2½" NW	✓						✓	Acoustical Material
1.5-3	G229	Joist	(varies) NW	✓						✓	Acoustical Material
1.5-2	G236	Joist	2½" NW	✓						✓	Acoustical Material
1.5-2	G243	Beam/Joist	2½" NW	✓						✓	Acoustical Material
2-3	G247	Beam/Joist	(varies) NW	✓						✓	Gypsum
1-3	G561	Beam/Joist	(varies) LW, NW	✓						✓	Gypsum
1-3	G710	Joist	(varies) LW, NW	✓						✓	SFRM
1-4	N789	Joist	(varies) LW, NW	✓						✓	SFRM

1. The profile designations used in this table apply to the profile families as summarized below:

- "B" – PLB & B FORMLOK deck
- "N3" – PLN3 & N3 FORMLOK deck
- "N" – PLN & N FORMLOK deck
- "W2" – PLW2 & W2 FORMLOK deck
- "W3" – PLW3 & W3 FORMLOK deck
- "DV" – 1½" Deep VERCOR deck

2. Refer to UL Fire Resistance Directory, evaluation reports for Verco Steel Deck, or municipality requirements for full details of construction including profile applicability, concrete thickness, strength requirements, and span limitations.
3. Denotes that the FORMLOK deck profile may be fluted or cellular.
4. Code-compliant Verco gray primer paint is formulated for compatibility with spray-applied fireproofing. Verco steel decks in the assemblies listed above may be galvanized or painted, excluding assemblies D924, D969, D973, D974, D976, and D977 which shall be galvanized only.
5. Protected assemblies have spray-applied fireproofing applied directly to the underside of the deck. Unprotected assemblies do not require spray-applied fireproofing applied to the underside of the deck. "SFRM = Spray-Applied Fire Resistive Materials."
6. Verco Decking, Inc. assumes no responsibility for adhesion of any spray-applied fireproofing material, nor for any treatment, cleaning, or surface preparation of the deck required for adhesion of fire protection material.
7. Concrete thickness is measured from top of deck to top of slab.
8. All assemblies except D750, D760, D775, D779, D924, D969, D973, D974, D976, D977, G213, G222, G227, G229, G236, G243, G547, G561, G710, and N789 are permitted to be blended. Blended deck refers to the allowed combination of cellular and non-cellular deck for the floor system.
9. Sidelap fastening by either button punch, seam weld, or VSC2 is required. Minimum ¾" long #10 self-drilling screws may be substituted for button punches at the spacing indicated for button punches – but only for an appropriate deck profile modified for this application.

ACOUSTICAL CELLULAR FORMLOK DECK

Verco 1½", 2" and 3" deep cellular FORMLOK decks are available as acoustical decks. Acoustical deck can provide sound attenuation within buildings where the underside of the deck is exposed to the interior.

Cellular Acoustical Deck Cellular PLB-CD, BCD, PLW2-CD, W2CD, PLW3-CD, W3CD, PLN3-CD, N3CD, PLN-CD and NCD FORMLOK decks are available with acoustical perforations in the flat bottom plate. Acoustical perforations are 5/32" in diameter on 7/16" staggered centers in bands centered under the top flanges of the fluted top sections. The insulation batts in acoustical cellular deck are factory installed as shown on page 109. The perforations in the flat bottom plates have a minimal impact on the deck section properties (vertical loads) as shown on pages 110 thru 114.

Above Deck Insulation The choice of above deck insulation has minimal impact on the acoustical performance of cellular deck therefore only poly-isocyanurate insulation was used in the tested assemblies. Comparative test results with alternate above deck materials available upon request.

Acoustical Insulation The acoustical batts used in cellular acoustical decks are available encapsulated (wrapped). Optional spacers may be installed in cellular acoustical decks between the flat bottom plate and the insulation batts. The acoustical performance of cellular acoustical decks with spacers is available on the Verco website at www.vercodeck.com.

Noise Reduction Coefficients Table 10 on page 35 summarizes the sound absorption coefficients for PLB-CD, BCD, PLW2-CD, W2CD, PLW3-CD, W3CD, PLN3-CD, N3CD, PLN-CD and NCD FORMLOK cellular acoustical decks at a number of frequencies. The acoustical test reports with the full range of absorption coefficients are available on the Verco website. The noise reduction coefficient (NRC) historically reported is the average of the coefficients at 250, 500, 1000, and 2000 Hz expressed to the nearest integral multiple of 0.05. The sound absorption average (SAA) is the average of the sound absorption coefficients for the twelve one-third octave bands from 200 through 2500 Hz inclusive, rounded to the nearest 0.01.

Table 10: Noise Reduction of Cellular Acoustical FORMLOK Deck

Profile	AC Insulation	Absorption Coefficients						SSA	NRC	RAL Test No.
		125 Hz	250 Hz	500 Hz	1000 Hz	2000 Hz	4000 Hz			
PLB-CD AC or BCD AC	Plain	0.17	0.60	0.91	1.06	0.76	0.53	0.82	0.85	A13-251
	Wrapped	0.34	0.53	0.76	0.55	0.40	0.33	0.57	0.55	A13-249
PLW2-CD AC or W2CD AC	Plain	0.32	0.55	0.79	0.89	0.62	0.48	0.71	0.70	A13-242
	Wrapped	0.34	0.53	0.98	0.78	0.45	0.32	0.69	0.70	A13-241
PLW3-CD AC or W3CD AC	Plain	0.50	0.77	0.98	0.77	0.62	0.50	0.77	0.80	A13-245
	Wrapped	0.46	0.74	1.09	0.68	0.55	0.34	0.76	0.75	A13-247
PLN3-CD AC or N3CD AC	Plain	0.58	0.70	1.16	0.93	0.79	0.63	0.90	0.90	A13-234
	Wrapped	0.54	0.70	0.92	0.67	0.50	0.33	0.70	0.70	A13-237
PLN-CD AC or NCD AC	Plain	0.84	0.79	1.16	0.98	0.82	0.60	0.96	0.95	A04-143

Notes:

AC - cellular deck with perforated bands in flat bottom plate
 Plain - unwrapped fiberglass insulation batts without facing
 Wrapped - encapsulated fiberglass insulation batts

Sound Transmission

Sound transmission between spaces within a structure or between the exterior and interior of a building is a function of the mass of the floor or roof assembly and is not greatly impacted by the choice of steel deck itself, with or without acoustical insulation.

Appearance

Acoustical decks are normally exposed to view, therefore it is appropriate to review the exposed product appearance considerations described on page 14.

SPECIFICATION SECTION 05 31 13 - STEEL FLOOR DECKING

Specifications utilizing VERCO floor deck formatted in accordance with MasterFormat 2012, Construction Specifications Institute (CSI) and Construction Specifications Canada (CSC) are available for download from Verco’s website (www.vercodeck.com).

Using the Tables

Figure 20 highlights important considerations for using the deck tables. (This figure is based on the tables found on page 40 of this catalog.)

Design information for the tables on each page.

Concrete weight excluding FORMLOK deck deflection allowance of 4 psf (NW) or 3 psf (LW).

PLB™ or B FORMLOK™

- 3½ in. TOTAL SLAB DEPTH
- Normal Weight Concrete

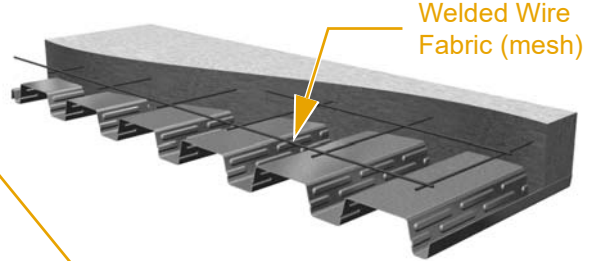

Welded Wire Fabric (mesh)

Maximum Unshored Clear Span (ft-in.)

Deck Gage	Number of Deck Spans		
	1	2	3
22	6'-6"	7'-8"	7'-9"
20	7'-9"	9'-1"	9'-3"
18	8'-10"	10'-8"	11'-0"
16	9'-6"	11'-10"	11'-7"

Concrete Properties

Density (pcf)	Uniform Weight (psf)	Uniform Volume (yd³/100 ft²)	Compressive Strength, f
145	30.6	0.781	3000

Notes:

1. Volumes and weights do not include allowance for deflection.
2. Weights are for concrete only and do not include weight of steel deck.
3. Total slab depth is nominal depth from top of concrete to bottom of steel deck.

Shoring is required for spans greater than those shown above. See Footnote 1 on page 39 for required bearing.

Shaded areas to the right of the black line in the "Allowable Superimposed Loads" table indicate that **shoring** is required during construction. For 22 gage deck shown below, single spans longer than 6'-6", double spans longer than 7'-8", and triple spans longer than 7'-9" must be shored.

Allowable Superimposed Load is the load the composite slab can support in addition to the weight of the deck and concrete.

Allowable Superimposed Loads (psf)

Deck Gage	Number of Deck Spans	Span (ft-in.)													
		4'-0"	5'-0"	6'-0"	6'-6"	7'-0"	7'-6"	8'-0"	8'-6"	9'-0"	9'-6"	10'-0"	10'-6"	11'-0"	11'-6"
22	1	400	353	261	228	170	148	130	115	101	90	80	71	64	57
	2	400	353	261	228	202	180	130	115	101	90	80	71	64	57
	3	400	353	261	228	202	180	130	115	101	90	80	71	64	57

See footnotes on page 39.

Shoring required in shaded areas to right

Allowable Diaphragm Shear Strengths, q (plf) and Flexibility Factors, F (in./lb. x 10⁶)

Attachment Pattern	Deck Gage	Span (ft-in.)														
		4'-0"	5'-0"	6'-0"	6'-6"	7'-0"	7'-6"	8'-0"	8'-6"	9'-0"	9'-6"	10'-0"	10'-6"	11'-0"	11'-6"	
36/7	22	q	2389	2177	2035	1981	1934	1893	1858	1827	1799	1774	1752	1732	1713	1694
		F	0.35	0.38	0.41	0.42	0.43	0.44	0.44	0.45	0.46	0.46	0.47	0.48	0.48	0.49
	20	q	2569	2315	2145	2079	2013	1975	1932	1895	1861	1832	1805	1780	1758	1739
		F	0.29	0.33	0.35	0.36	0.37	0.38	0.39	0.40	0.40	0.41	0.42	0.42	0.43	0.44
	18	q	2947	2607	2381	2294	2219	2155	2098	2048	2004	1964	1929	1896	1867	1841
		F	0.22	0.25	0.27	0.28	0.29	0.30	0.31	0.32	0.33	0.33	0.34	0.34	0.35	0.36
	16	q	3342	2917	2634	2525	2432	2351	2280	2218	2162	2113	2068	2027	1991	1957
		F	0.17	0.20	0.22	0.23	0.24	0.25	0.26	0.26	0.27	0.28	0.28	0.29	0.29	0.30

See footnotes on page 39.

Attachment Pattern

Allowable Diaphragm Shear Strength (q) and Flexibility Factor (F) based on attachment pattern.

FIGURE 20

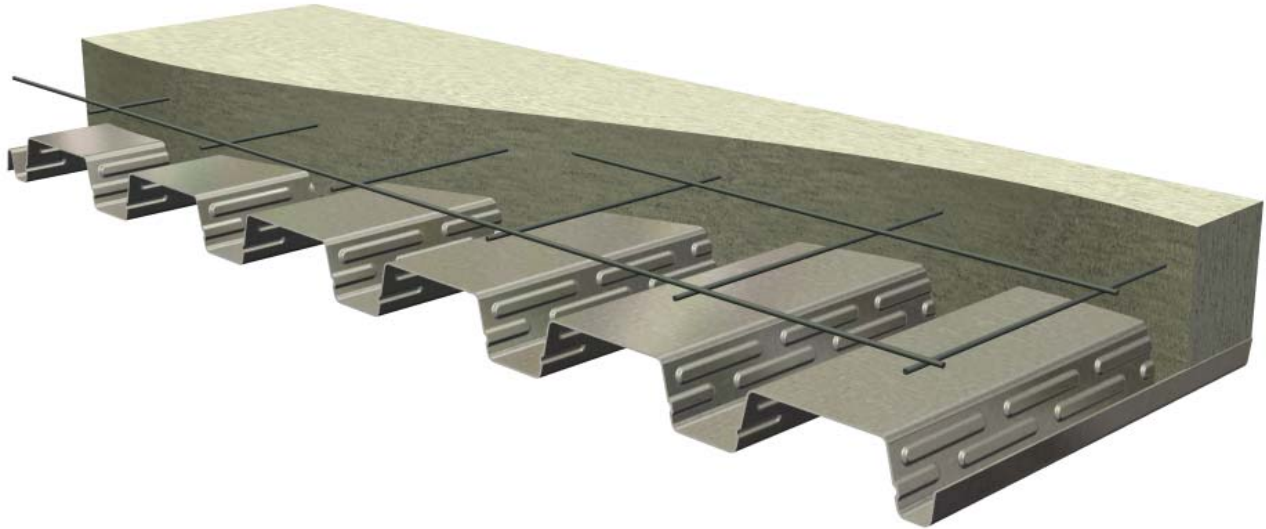

PLB™ FORMLOK™ and B FORMLOK™

PLB™ AND B FORMLOK™ CONTENTS

Section Properties	38
PLB™ and B FORMLOK™ Tables	40-48
3½ in. Total Slab Depth Normal Weight Concrete	40
4 in. Total Slab Depth Normal Weight Concrete	41
4½ in. Total Slab Depth Normal Weight Concrete	42
5 in. Total Slab Depth Normal Weight Concrete	43
6 in. Total Slab Depth Normal Weight Concrete	44
3½ in. Total Slab Depth Light Weight Concrete	45
4 in. Total Slab Depth Light Weight Concrete	46
4¾ in. Total Slab Depth Light Weight Concrete	47
5¾ in. Total Slab Depth Light Weight Concrete	48

PLB™ or B FORMLOK™

- 1½ in. Deep FORMLOK Deck
- Phosphatized/Painted or Galvanized
- PLB FORMLOK used with PunchLok II System
- B FORMLOK used with TSWs or BPs
- B FORMLOK-SS used with Screws

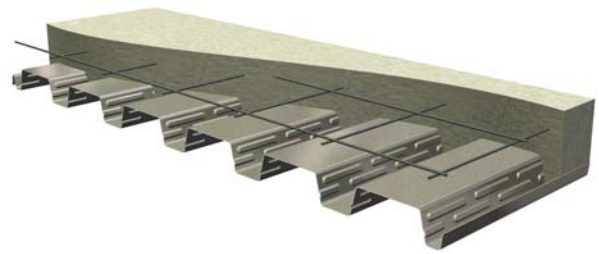

Dimensions

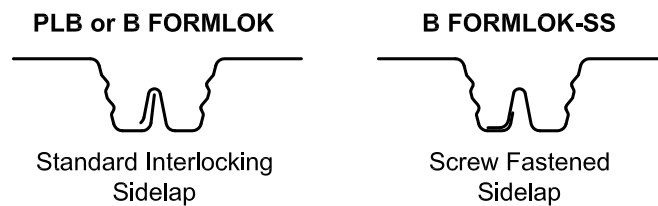
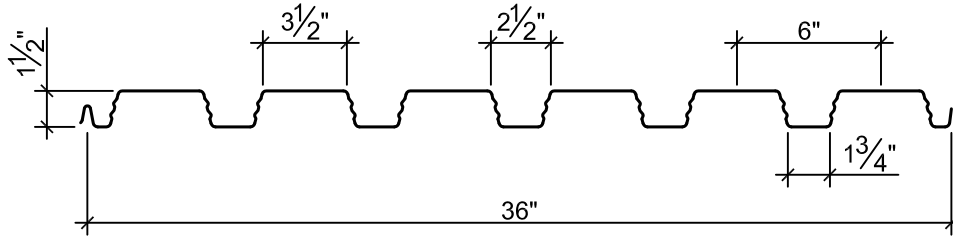

Deck Weight and Section Properties

Gage	Weight		I_d for Deflection		Moment		Allowable Reactions per ft of Width (lb) due to Web Crippling									
	Galv (psf)	Painted (psf)	Single Span (in. ⁴ /ft)	Multi Span (in. ⁴ /ft)	+ S_{eff} (in. ³ /ft)	- S_{eff} (in. ³ /ft)	One Flange Loading				Two Flange Loading					
							End Bearing Length		Interior Bearing Length		End Bearing Length		Interior Bearing Length			
							2"	3"	4"	3"	4"	2"	3"	4"	3"	4"
22	1.9	1.8	0.177	0.192	0.176	0.188	935	1076	1163	1559	1671	962	1078	1150	1935	2084
20	2.3	2.2	0.219	0.231	0.230	0.237	1301	1492	1609	2190	2340	1413	1576	1675	2744	2947
18	2.9	2.8	0.302	0.306	0.314	0.331	2181	2484	2667	3714	3950	2551	2823	2987	4713	5038
16	3.5	3.4	0.381	0.381	0.399	0.410	3265	3699	3955	5607	5938	4018	4422	4660	7168	7631

- Notes:**
1. Section properties are based on $F_y = 50,000$ psi.
 2. I_d is for deflection due to uniform loads.
 3. S_{eff} (+ or -) is the effective section modulus.
 4. Allowable (ASD) reactions are based on web crippling, per AISI S100 Section C3.4, where $\Omega_w = 1.70$ for end bearing and 1.75 for interior bearing. Nominal reactions may be determined by multiplying the table values by Ω_w . LRFD reactions may be determined by multiplying nominal reactions by $\phi_w = 0.9$ for end reactions and 0.85 for interior reactions.

Attachment Patterns to Supports

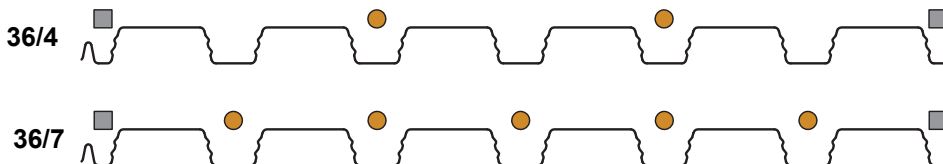

- Note:** ● indicates location of arc spot weld, power actuated fastener, or screw as indicated in the load tables.
 ■ indicates location of arc seam weld, power actuated fastener, or screw as indicated in the load tables.

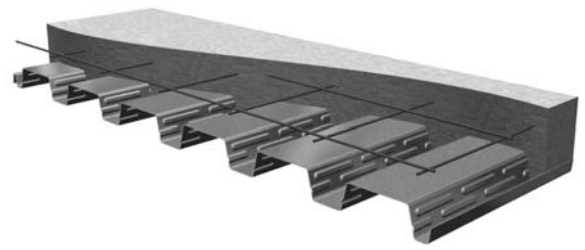

Footnotes for Maximum Unshored Clear Span, Allowable Superimposed Loads, and Allowable Diaphragm Shear Strength Tables

1. Shoring calculations are based on the following:
 - Deck supporting dead load of concrete plus 20 psf uniform construction load or 150 pound concentrated construction live load for flexure. 4 psf is added for normal weight concrete and 3 psf is added for light weight concrete to account for ponding due to deck deflection between support members.
 - Dead load deflection limited to L/180 of span length, not to exceed 3/4".
 - Minimum end and interior bearing of 2".
2. Concrete fill to have minimum 28-day compressive strength $f'_c = 3,000$ psi.
3. Total slab depth is nominal depth from top of concrete to bottom of steel deck.
4. Shoring is required at midspan for allowable superimposed loads in the shaded area to the right of the heavy line.
5. Nominal diaphragm shear strengths may be determined by multiplying the tabulated strengths by $\Omega = 3.0$. LRFD diaphragm shear strength may be determined by multiplying nominal diaphragm shear strength by $\phi = 0.55$.
6. To obtain allowable diaphragm shear strengths using mechanical fasteners, multiply the tabulated strengths by the appropriate adjustment factor, A_q listed in the following table.

Attachment Pattern	Adjustment Factor	Total Slab Depth (in.)								
		Normal Weight Concrete				Light Weight Concrete				
		3 1/2	4	4 1/2	5	6	3 1/2	4	4 3/4	5 3/4
36/4	A_{q4}	0.60	0.66	0.68	0.62	0.53	0.46	0.53	0.62	0.69
36/7	A_{q7}	0.49	0.57	0.62	0.66	0.72	0.38	0.44	0.52	0.61

Notes:

- a. Mechanical fastener attachment patterns are to match the listed attachment patterns for welds.
- b. Applicable mechanical fasteners are limited to the following: Hilti Fasteners, Pneutek Fasteners and SDI Recognized #12 or #14 Screws produced by Buildex, Elco, Hilti or Simpson Strong-Tie. Comply with minimum and maximum substrate thickness requirements for applicable mechanical fasteners. Note that these adjustment factors are based on the most conservative value for all listed connectors.
- c. Nominal diaphragm shear strengths for mechanically fastened FORMLOK slabs may be determined by multiplying the adjusted tabulated strengths by $\Omega = 3.25$. LRFD diaphragm shear strengths for mechanically fastened FORMLOK slabs may be determined by multiplying the adjusted nominal strengths by $\phi = 0.50$.
- d. Consult fastener manufacturer for applicable fire-resistance assembly ratings where mechanical fasteners are required.

PLB™ or B FORMLOK™

- 3½ in. TOTAL SLAB DEPTH
- Normal Weight Concrete

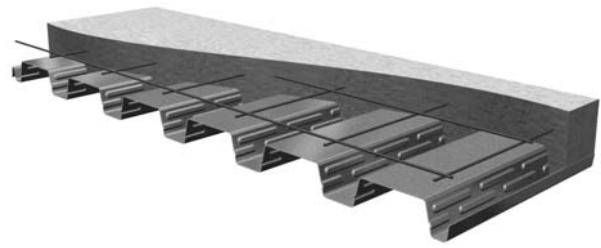

Maximum Unshored Clear Span (ft-in.)

Deck Gage	Number of Deck Spans		
	1	2	3
22	6'-6"	7'-8"	7'-9"
20	7'-9"	9'-1"	9'-3"
18	8'-10"	10'-8"	11'-0"
16	9'-6"	11'-10"	11'-7"

Shoring is required for spans greater than those shown above. See Footnote 1 on page 39 for required bearing.

Concrete Properties

Density (pcf)	Uniform Weight (psf)	Uniform Volume (yd ³ /100 ft ²)	Compressive Strength, f' _c (psi)
145	30.6	0.781	3000

Notes:

1. Volumes and weights do not include allowance for deflection.
2. Weights are for concrete only and do not include weight of steel deck.
3. Total slab depth is nominal depth from top of concrete to bottom of steel deck.

Allowable Superimposed Loads (psf)

Deck Gage	Number of Deck Spans	Span (ft-in.)														
		4'-0"	5'-0"	6'-0"	6'-6"	7'-0"	7'-6"	8'-0"	8'-6"	9'-0"	9'-6"	10'-0"	10'-6"	11'-0"	11'-6"	12'-0"
22	1	400	353	261	228	170	148	130	115	101	90	80	71	64	57	51
	2	400	353	261	228	202	180	130	115	101	90	80	71	64	57	51
	3	400	353	261	228	202	180	130	115	101	90	80	71	64	57	51
20	1	400	372	274	240	212	189	138	122	108	96	85	76	68	61	55
	2	400	372	274	240	212	189	170	153	140	96	85	76	68	61	55
	3	400	372	274	240	212	189	170	153	140	96	85	76	68	61	55
18	1	400	400	297	260	230	205	184	166	119	106	95	85	76	68	61
	2	400	400	297	260	230	205	184	166	151	138	127	117	76	68	61
	3	400	400	297	260	230	205	184	166	151	138	127	117	108	68	61
16	1	400	400	297	260	230	205	184	166	151	138	94	84	75	68	61
	2	400	400	297	260	230	205	184	166	151	138	127	117	108	100	61
	3	400	400	297	260	230	205	184	166	151	138	127	117	108	100	61

See footnotes on page 39.

Shoring required in shaded areas to right of heavy line.

Allowable Diaphragm Shear Strengths, q (plf) and Flexibility Factors, F (in./lb. x 10⁶)

Attachment Pattern	Deck Gage	Span (ft-in.)															
		4'-0"	5'-0"	6'-0"	6'-6"	7'-0"	7'-6"	8'-0"	8'-6"	9'-0"	9'-6"	10'-0"	10'-6"	11'-0"	11'-6"	12'-0"	
36/4	22	q	2074	1925	1825	1787	1754	1726	1701	1679	1659	1642	1626	1612	1599	1587	1576
		F	0.40	0.43	0.45	0.46	0.47	0.48	0.48	0.49	0.50	0.50	0.51	0.51	0.52	0.52	0.52
	20	q	2192	2013	1893	1847	1808	1773	1743	1717	1694	1673	1654	1637	1621	1607	1594
		F	0.34	0.37	0.40	0.41	0.42	0.42	0.43	0.44	0.44	0.45	0.45	0.46	0.46	0.47	0.47
	18	q	2444	2205	2046	1985	1932	1887	1847	1812	1781	1753	1728	1705	1684	1665	1648
		F	0.27	0.30	0.32	0.33	0.34	0.35	0.35	0.36	0.37	0.37	0.38	0.38	0.39	0.39	0.40
16	q	2713	2414	2215	2138	2073	2016	1966	1922	1883	1848	1816	1788	1762	1738	1717	
	F	0.21	0.24	0.26	0.27	0.28	0.29	0.30	0.30	0.31	0.32	0.32	0.33	0.33	0.34	0.34	
36/7	22	q	2389	2177	2035	1981	1934	1893	1858	1827	1799	1774	1752	1732	1713	1697	1681
		F	0.35	0.38	0.41	0.42	0.43	0.44	0.44	0.45	0.46	0.46	0.47	0.48	0.48	0.49	0.49
	20	q	2569	2315	2145	2079	2023	1975	1932	1895	1861	1832	1805	1780	1758	1738	1720
		F	0.29	0.33	0.35	0.36	0.37	0.38	0.39	0.40	0.40	0.41	0.42	0.42	0.43	0.43	0.44
	18	q	2947	2607	2381	2294	2219	2155	2098	2048	2004	1964	1929	1896	1867	1840	1815
		F	0.22	0.25	0.27	0.28	0.29	0.30	0.31	0.32	0.33	0.33	0.34	0.34	0.35	0.35	0.36
	16	q	3342	2917	2634	2525	2432	2351	2280	2218	2162	2113	2068	2027	1991	1957	1926
		F	0.17	0.20	0.22	0.23	0.24	0.25	0.26	0.26	0.27	0.28	0.28	0.29	0.29	0.30	0.30

See footnotes on page 39.

PLB™ or B FORMLOK™

- 4 in. TOTAL SLAB DEPTH
- Normal Weight Concrete

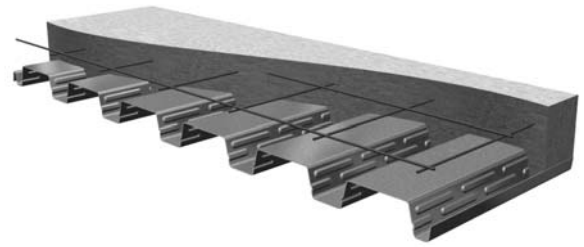

Maximum Unshored Clear Span (ft-in.)

Deck Gage	Number of Deck Spans		
	1	2	3
22	6'-2"	7'-3"	7'-4"
20	7'-5"	8'-8"	8'-9"
18	8'-5"	10'-2"	10'-5"
16	9'-1"	11'-3"	11'-2"

Shoring is required for spans greater than those shown above. See Footnote 1 on page 39 for required bearing.

Concrete Properties

Density (pcf)	Uniform Weight (psf)	Uniform Volume (yd ³ /100 ft ²)	Compressive Strength, f' _c (psi)
145	36.6	0.936	3000

Notes:

1. Volumes and weights do not include allowance for deflection.
2. Weights are for concrete only and do not include weight of steel deck.
3. Total slab depth is nominal depth from top of concrete to bottom of steel deck.

Allowable Superimposed Loads (psf)

Deck Gage	Number of Deck Spans	Span (ft-in.)															
		4'-0"	5'-0"	6'-0"	6'-6"	7'-0"	7'-6"	8'-0"	8'-6"	9'-0"	9'-6"	10'-0"	10'-6"	11'-0"	11'-6"	12'-0"	
22	1	400	400	303	229	198	173	151	133	118	104	93	83	74	66	59	
	2	400	400	303	265	234	173	151	133	118	104	93	83	74	66	59	
	3	400	400	303	265	234	173	151	133	118	104	93	83	74	66	59	
20	1	400	400	318	279	246	183	160	141	125	111	99	89	79	71	64	
	2	400	400	318	279	246	220	197	178	125	111	99	89	79	71	64	
	3	400	400	318	279	246	220	197	178	125	111	99	89	79	71	64	
18	1	400	400	344	301	266	237	213	155	138	123	109	98	88	79	71	
	2	400	400	344	301	266	237	213	192	175	160	147	98	88	79	71	
	3	400	400	344	301	266	237	213	192	175	160	147	98	88	79	71	
16	1	400	400	342	300	265	236	212	192	174	121	108	97	87	78	70	
	2	400	400	342	300	265	236	212	192	174	159	146	135	125	78	70	
	3	400	400	342	300	265	236	212	192	174	159	146	135	125	78	70	

See footnotes on page 39.

Shoring required in shaded areas to right of heavy line.

Allowable Diaphragm Shear Strengths, q (plf) and Flexibility Factors, F (in./lb. x 10⁶)

Attachment Pattern	Deck Gage	Span (ft-in.)															
		4'-0"	5'-0"	6'-0"	6'-6"	7'-0"	7'-6"	8'-0"	8'-6"	9'-0"	9'-6"	10'-0"	10'-6"	11'-0"	11'-6"	12'-0"	
36/4	22	q	2314	2164	2065	2026	1993	1965	1940	1918	1898	1881	1865	1851	1838	1826	1815
		F	0.36	0.38	0.40	0.41	0.41	0.42	0.42	0.43	0.43	0.44	0.44	0.45	0.45	0.45	0.45
	20	q	2431	2252	2132	2086	2047	2012	1983	1956	1933	1912	1893	1876	1860	1846	1833
		F	0.31	0.33	0.35	0.36	0.37	0.37	0.38	0.38	0.39	0.39	0.40	0.40	0.40	0.41	0.41
	18	q	2683	2444	2285	2224	2171	2126	2086	2051	2020	1992	1967	1944	1923	1904	1887
		F	0.24	0.27	0.29	0.29	0.30	0.31	0.31	0.32	0.32	0.33	0.33	0.34	0.34	0.34	0.35
16	q	2952	2653	2454	2377	2312	2255	2205	2161	2122	2087	2055	2027	2001	1978	1956	
	F	0.20	0.22	0.24	0.25	0.25	0.26	0.26	0.27	0.27	0.28	0.28	0.29	0.29	0.29	0.30	
36/7	22	q	2628	2416	2274	2220	2173	2133	2097	2066	2038	2013	1991	1971	1952	1936	1920
		F	0.31	0.34	0.36	0.37	0.38	0.39	0.39	0.40	0.40	0.41	0.41	0.42	0.42	0.43	0.43
	20	q	2809	2554	2384	2318	2262	2214	2171	2134	2100	2071	2044	2020	1997	1977	1959
		F	0.27	0.29	0.32	0.32	0.33	0.34	0.35	0.35	0.36	0.36	0.37	0.37	0.38	0.38	0.38
	18	q	3186	2846	2620	2533	2459	2394	2337	2287	2243	2203	2168	2135	2106	2079	2055
		F	0.20	0.23	0.25	0.26	0.27	0.27	0.28	0.29	0.29	0.30	0.30	0.31	0.31	0.31	0.32
	16	q	3581	3156	2873	2764	2671	2590	2519	2457	2401	2352	2307	2267	2230	2196	2165
		F	0.16	0.18	0.20	0.21	0.22	0.23	0.23	0.24	0.24	0.25	0.25	0.26	0.26	0.27	0.27

See footnotes on page 39.

PLB™ or B FORMLOK™

- 4½ in. TOTAL SLAB DEPTH
- Normal Weight Concrete

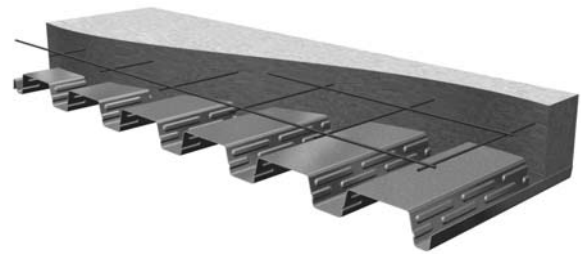

Maximum Unshored Clear Span (ft-in.)

Deck Gage	Number of Deck Spans		
	1	2	3
22	5'-11"	6'-11"	7'-0"
20	7'-1"	8'-3"	8'-4"
18	8'-1"	9'-9"	10'-0"
16	8'-8"	10'-9"	10'-9"

Shoring is required for spans greater than those shown above. See Footnote 1 on page 39 for required bearing.

Concrete Properties

Density (pcf)	Uniform Weight (psf)	Uniform Volume (yd ³ /100 ft ²)	Compressive Strength, f' _c (psi)
145	42.7	1.090	3000

Notes:

1. Volumes and weights do not include allowance for deflection.
2. Weights are for concrete only and do not include weight of steel deck.
3. Total slab depth is nominal depth from top of concrete to bottom of steel deck.

Allowable Superimposed Loads (psf)

Deck Gage	Number of Deck Spans	Span (ft-in.)															
		4'-0"	5'-0"	6'-0"	6'-6"	7'-0"	7'-6"	8'-0"	8'-6"	9'-0"	9'-6"	10'-0"	10'-6"	11'-0"	11'-6"	12'-0"	
22	1	400	400	306	263	227	198	174	153	135	120	107	95	85	76	68	
	2	400	400	348	304	227	198	174	153	135	120	107	95	85	76	68	
	3	400	400	348	304	269	198	174	153	135	120	107	95	85	76	68	
20	1	400	400	365	319	282	210	184	162	144	128	114	102	91	81	73	
	2	400	400	365	319	282	252	226	162	144	128	114	102	91	81	73	
	3	400	400	365	319	282	252	226	162	144	128	114	102	91	81	73	
18	1	400	400	393	344	304	271	244	178	158	140	125	112	101	90	81	
	2	400	400	393	344	304	271	244	220	200	183	125	112	101	90	81	
	3	400	400	393	344	304	271	244	220	200	183	168	112	101	90	81	
16	1	400	400	391	342	302	269	242	219	156	138	124	111	99	89	80	
	2	400	400	391	342	302	269	242	219	199	182	167	154	99	89	80	
	3	400	400	391	342	302	269	242	219	199	182	167	154	99	89	80	

See footnotes on page 39.

Shoring required in shaded areas to right of heavy line.

Allowable Diaphragm Shear Strengths, q (plf) and Flexibility Factors, F (in./lb. x 10⁶)

Attachment Pattern	Deck Gage	Span (ft-in.)															
		4'-0"	5'-0"	6'-0"	6'-6"	7'-0"	7'-6"	8'-0"	8'-6"	9'-0"	9'-6"	10'-0"	10'-6"	11'-0"	11'-6"	12'-0"	
36/4	22	q	2553	2403	2304	2265	2232	2204	2179	2157	2138	2120	2104	2090	2077	2065	2055
		F	0.32	0.34	0.36	0.36	0.37	0.37	0.38	0.38	0.39	0.39	0.39	0.39	0.40	0.40	0.40
	20	q	2670	2491	2371	2325	2286	2252	2222	2195	2172	2151	2132	2115	2099	2085	2072
		F	0.28	0.30	0.32	0.32	0.33	0.33	0.34	0.34	0.35	0.35	0.35	0.36	0.36	0.36	0.36
	18	q	2922	2683	2524	2463	2410	2365	2325	2290	2259	2231	2206	2183	2162	2143	2126
		F	0.22	0.24	0.26	0.26	0.27	0.28	0.28	0.28	0.29	0.29	0.30	0.30	0.30	0.30	0.31
16	q	3191	2892	2693	2616	2551	2494	2444	2400	2361	2326	2295	2266	2240	2217	2195	
	F	0.18	0.20	0.22	0.22	0.23	0.23	0.24	0.24	0.25	0.25	0.25	0.26	0.26	0.26	0.27	
36/7	22	q	2867	2655	2513	2459	2412	2372	2336	2305	2277	2252	2230	2210	2191	2175	2159
		F	0.29	0.31	0.33	0.34	0.34	0.35	0.35	0.36	0.36	0.37	0.37	0.37	0.38	0.38	0.38
	20	q	3048	2793	2623	2557	2501	2453	2410	2373	2340	2310	2283	2259	2237	2216	2198
		F	0.25	0.27	0.29	0.29	0.30	0.31	0.31	0.32	0.32	0.33	0.33	0.33	0.34	0.34	0.34
	18	q	3425	3086	2859	2772	2698	2633	2576	2527	2482	2442	2407	2374	2345	2318	2294
		F	0.19	0.21	0.23	0.24	0.24	0.25	0.25	0.26	0.26	0.27	0.27	0.27	0.28	0.28	0.28
	16	q	3820	3395	3112	3003	2910	2829	2758	2696	2640	2591	2546	2506	2469	2435	2405
		F	0.15	0.17	0.19	0.19	0.20	0.21	0.21	0.22	0.22	0.22	0.23	0.23	0.24	0.24	0.24

See footnotes on page 39.

PLB™ or B FORMLOK™

- 5 in. TOTAL SLAB DEPTH
- Normal Weight Concrete
- 1 Hour Fire Rating

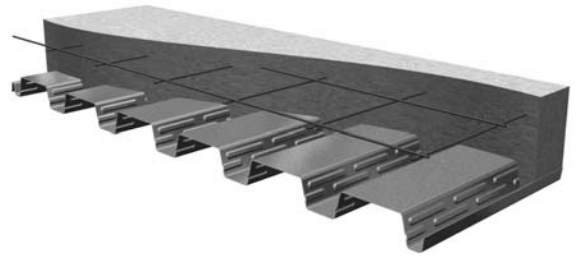

Maximum Unshored Clear Span (ft-in.)

Deck Gage	Number of Deck Spans		
	1	2	3
22	5'-8"	6'-8"	6'-9"
20	6'-9"	7'-11"	8'-0"
18	7'-9"	9'-4"	9'-7"
16	8'-4"	10'-4"	10'-4"

Shoring is required for spans greater than those shown above. See Footnote 1 on page 39 for required bearing.

Concrete Properties

Density (pcf)	Uniform Weight (psf)	Uniform Volume (yd ³ /100 ft ²)	Compressive Strength, f' _c (psi)
145	48.7	1.244	3000

Notes:

1. Volumes and weights do not include allowance for deflection.
2. Weights are for concrete only and do not include weight of steel deck.
3. Total slab depth is nominal depth from top of concrete to bottom of steel deck.

Allowable Superimposed Loads (psf)

Deck Gage	Number of Deck Spans	Span (ft-in.)															
		4'-0"	5'-0"	6'-0"	6'-6"	7'-0"	7'-6"	8'-0"	8'-6"	9'-0"	9'-6"	10'-0"	10'-6"	11'-0"	11'-6"	12'-0"	
22	1	400	400	347	297	257	224	197	173	153	136	121	108	96	86	77	
	2	400	400	393	344	257	224	197	173	153	136	121	108	96	86	77	
	3	400	400	393	344	257	224	197	173	153	136	121	108	96	86	77	
20	1	400	400	400	361	272	237	208	184	163	145	129	115	103	92	83	
	2	400	400	400	361	319	284	208	184	163	145	129	115	103	92	83	
	3	400	400	400	361	319	284	255	184	163	145	129	115	103	92	83	
18	1	400	400	400	389	344	306	227	201	178	159	142	127	114	103	92	
	2	400	400	400	389	344	306	275	249	226	159	142	127	114	103	92	
	3	400	400	400	389	344	306	275	249	226	207	142	127	114	103	92	
16	1	400	400	400	386	341	304	273	198	176	157	140	125	112	101	91	
	2	400	400	400	386	341	304	273	247	224	205	188	125	112	101	91	
	3	400	400	400	386	341	304	273	247	224	205	188	125	112	101	91	

See footnotes on page 39.

Shoring required in shaded areas to right of heavy line.

Allowable Diaphragm Shear Strengths, q (plf) and Flexibility Factors, F (in./lb. x 10⁶)

Attachment Pattern	Deck Gage	Span (ft-in.)															
		4'-0"	5'-0"	6'-0"	6'-6"	7'-0"	7'-6"	8'-0"	8'-6"	9'-0"	9'-6"	10'-0"	10'-6"	11'-0"	11'-6"	12'-0"	
36/4	22	q	2792	2642	2543	2504	2472	2443	2418	2396	2377	2359	2343	2329	2316	2304	2294
		F	0.30	0.31	0.32	0.33	0.33	0.34	0.34	0.34	0.35	0.35	0.35	0.35	0.36	0.36	0.36
	20	q	2909	2730	2610	2564	2525	2491	2461	2434	2411	2390	2371	2354	2338	2324	2311
		F	0.26	0.28	0.29	0.29	0.30	0.30	0.31	0.31	0.31	0.31	0.32	0.32	0.32	0.32	0.33
	18	q	3161	2923	2763	2702	2650	2604	2564	2529	2498	2470	2445	2422	2401	2382	2365
		F	0.21	0.22	0.24	0.24	0.25	0.25	0.25	0.26	0.26	0.26	0.27	0.27	0.27	0.27	0.28
16	q	3430	3131	2932	2856	2790	2733	2683	2639	2600	2565	2534	2505	2479	2456	2434	
	F	0.17	0.19	0.20	0.20	0.21	0.21	0.22	0.22	0.22	0.23	0.23	0.23	0.24	0.24	0.24	
36/7	22	q	3106	2894	2752	2698	2651	2611	2575	2544	2516	2492	2469	2449	2431	2414	2398
		F	0.27	0.28	0.30	0.31	0.31	0.32	0.32	0.32	0.33	0.33	0.33	0.34	0.34	0.34	0.34
	20	q	3287	3032	2862	2796	2740	2692	2649	2612	2579	2549	2522	2498	2476	2455	2437
		F	0.23	0.25	0.26	0.27	0.27	0.28	0.28	0.29	0.29	0.30	0.30	0.30	0.30	0.31	0.31
	18	q	3664	3325	3098	3011	2937	2872	2816	2766	2721	2682	2646	2613	2584	2557	2533
		F	0.18	0.20	0.21	0.22	0.22	0.23	0.23	0.24	0.24	0.24	0.25	0.25	0.25	0.25	0.26
16	q	4059	3634	3351	3242	3149	3068	2997	2935	2880	2830	2785	2745	2708	2674	2644	
	F	0.14	0.16	0.17	0.18	0.19	0.19	0.19	0.20	0.20	0.21	0.21	0.21	0.22	0.22	0.22	

See footnotes on page 39.

PLB™ or B FORMLOK™

- 6 in. TOTAL SLAB DEPTH
- Normal Weight Concrete
- 2 Hour Fire Rating

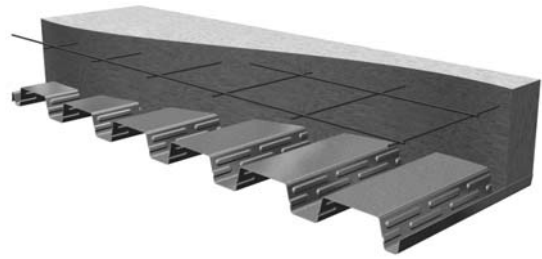

Maximum Unshored Clear Span (ft-in.)

Deck Gage	Number of Deck Spans		
	1	2	3
22	5'-4"	6'-2"	6'-3"
20	6'-3"	7'-4"	7'-5"
18	7'-3"	8'-8"	8'-11"
16	7'-10"	9'-7"	9'-8"

Concrete Properties

Density (pcf)	Uniform Weight (psf)	Uniform Volume (yd ³ /100 ft ²)	Compressive Strength, f _c (psi)
145	60.8	1.553	3000

Notes:

1. Volumes and weights do not include allowance for deflection.
2. Weights are for concrete only and do not include weight of steel deck.
3. Total slab depth is nominal depth from top of concrete to bottom of steel deck.

Shoring is required for spans greater than those shown above. See Footnote 1 on page 39 for required bearing.

Allowable Superimposed Loads (psf)

Deck Gage	Number of Deck Spans	Span (ft-in.)														
		4'-0"	5'-0"	6'-0"	6'-6"	7'-0"	7'-6"	8'-0"	8'-6"	9'-0"	9'-6"	10'-0"	10'-6"	11'-0"	11'-6"	12'-0"
22	1	400	400	400	369	320	279	244	215	191	169	151	134	120	107	96
	2	400	400	400	369	320	279	244	215	191	169	151	134	120	107	96
	3	400	400	400	369	320	279	244	215	191	169	151	134	120	107	96
20	1	400	400	400	389	337	295	259	228	202	180	160	143	128	115	103
	2	400	400	400	400	395	295	259	228	202	180	160	143	128	115	103
	3	400	400	400	400	395	295	259	228	202	180	160	143	128	115	103
18	1	400	400	400	400	400	321	282	250	222	197	177	158	142	128	115
	2	400	400	400	400	400	379	340	308	222	197	177	158	142	128	115
	3	400	400	400	400	400	379	340	308	222	197	177	158	142	128	115
16	1	400	400	400	400	400	376	279	246	219	195	174	156	140	126	113
	2	400	400	400	400	400	376	337	305	277	253	174	156	140	126	113
	3	400	400	400	400	400	376	337	305	277	253	174	156	140	126	113

See footnotes on page 39.

Shoring required in shaded areas to right of heavy line.

Allowable Diaphragm Shear Strengths, q (plf) and Flexibility Factors, F (in./lb. x 10⁶)

Attachment Pattern	Deck Gage	Span (ft-in.)															
		4'-0"	5'-0"	6'-0"	6'-6"	7'-0"	7'-6"	8'-0"	8'-6"	9'-0"	9'-6"	10'-0"	10'-6"	11'-0"	11'-6"	12'-0"	
36/4	22	q	3270	3120	3021	2983	2950	2921	2896	2874	2855	2837	2822	2807	2794	2783	2772
		F	0.25	0.26	0.27	0.28	0.28	0.28	0.28	0.29	0.29	0.29	0.29	0.29	0.29	0.30	0.30
	20	q	3387	3208	3088	3042	3003	2969	2939	2912	2889	2868	2849	2832	2817	2802	2789
		F	0.22	0.23	0.24	0.25	0.25	0.25	0.26	0.26	0.26	0.26	0.26	0.27	0.27	0.27	0.27
	18	q	3640	3401	3241	3180	3128	3082	3042	3007	2976	2948	2923	2900	2880	2861	2843
		F	0.18	0.19	0.20	0.21	0.21	0.21	0.21	0.22	0.22	0.22	0.22	0.22	0.23	0.23	0.23
16	q	3908	3610	3410	3334	3268	3211	3161	3117	3078	3043	3012	2983	2957	2934	2912	
	F	0.15	0.16	0.17	0.17	0.18	0.18	0.18	0.19	0.19	0.19	0.19	0.20	0.20	0.20	0.20	
36/7	22	q	3584	3372	3230	3176	3129	3089	3053	3022	2995	2970	2947	2927	2909	2892	2877
		F	0.23	0.24	0.26	0.26	0.26	0.27	0.27	0.27	0.28	0.28	0.28	0.28	0.28	0.29	0.29
	20	q	3765	3510	3340	3275	3219	3170	3128	3090	3057	3027	3000	2976	2954	2934	2915
		F	0.20	0.21	0.23	0.23	0.23	0.24	0.24	0.24	0.25	0.25	0.25	0.25	0.25	0.26	0.26
	18	q	4142	3803	3577	3490	3415	3350	3294	3244	3199	3160	3124	3092	3062	3035	3011
		F	0.16	0.17	0.18	0.19	0.19	0.19	0.20	0.20	0.20	0.21	0.21	0.21	0.21	0.21	0.22
16	q	4537	4113	3829	3721	3627	3546	3476	3413	3358	3308	3263	3223	3186	3153	3122	
	F	0.13	0.14	0.15	0.16	0.16	0.16	0.17	0.17	0.17	0.18	0.18	0.18	0.18	0.18	0.19	

See footnotes on page 39.

PLB™ or B FORMLOK™

- 3½ in. TOTAL SLAB DEPTH
- Light Weight Concrete

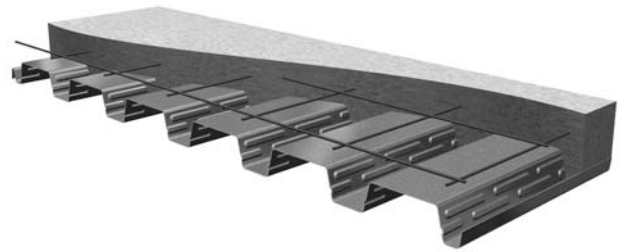

Maximum Unshored Clear Span (ft-in.)

Deck Gage	Number of Deck Spans		
	1	2	3
22	7'-0"	8'-3"	8'-4"
20	8'-5"	9'-10"	10'-0"
18	9'-8"	11'-7"	11'-9"
16	10'-4"	12'-9"	12'-4"

Shoring is required for spans greater than those shown above. See Footnote 1 on page 39 for required bearing.

Concrete Properties

Density (pcf)	Uniform Weight (psf)	Uniform Volume (yd ³ /100 ft ²)	Compressive Strength, f' _c (psi)
110	23.2	0.781	3000

Notes:

1. Volumes and weights do not include allowance for deflection.
2. Weights are for concrete only and do not include weight of steel deck.
3. Total slab depth is nominal depth from top of concrete to bottom of steel deck.

Allowable Superimposed Loads (psf)

Deck Gage	Number of Deck Spans	Span (ft-in.)															
		4'-0"	5'-0"	6'-0"	6'-6"	7'-0"	7'-6"	8'-0"	8'-6"	9'-0"	9'-6"	10'-0"	10'-6"	11'-0"	11'-6"	12'-0"	
22	1	400	400	261	228	202	156	137	122	109	97	87	78	71	62	54	
	2	400	400	261	228	202	180	161	122	109	97	87	78	71	62	54	
	3	400	400	261	228	202	180	161	122	109	97	87	78	71	62	54	
20	1	400	400	274	240	212	189	170	129	115	103	93	84	75	67	59	
	2	400	400	274	240	212	189	170	153	140	119	93	84	75	67	59	
	3	400	400	274	240	212	189	170	153	140	119	102	84	75	67	59	
18	1	400	400	297	260	230	205	184	166	151	135	102	92	83	76	67	
	2	400	400	297	260	230	205	184	166	151	135	116	100	87	76	67	
	3	400	400	297	260	230	205	184	166	151	135	116	100	87	76	67	
16	1	400	400	297	260	230	205	184	166	151	138	127	91	83	75	68	
	2	400	400	297	260	230	205	184	166	151	138	127	111	96	84	74	
	3	400	400	297	260	230	205	184	166	151	138	127	111	96	84	74	

See footnotes on page 39.

Shoring required in shaded areas to right of heavy line.

Allowable Diaphragm Shear Strengths, q (plf) and Flexibility Factors, F (in./lb. x 10⁶)

Attachment Pattern	Deck Gage	Span (ft-in.)															
		4'-0"	5'-0"	6'-0"	6'-6"	7'-0"	7'-6"	8'-0"	8'-6"	9'-0"	9'-6"	10'-0"	10'-6"	11'-0"	11'-6"	12'-0"	
36/4	22	q	1750	1601	1501	1463	1430	1401	1376	1354	1335	1317	1302	1287	1275	1263	1252
		F	0.47	0.52	0.55	0.56	0.58	0.59	0.60	0.61	0.62	0.63	0.63	0.64	0.65	0.65	0.66
	20	q	1868	1688	1569	1523	1483	1449	1419	1393	1369	1348	1329	1312	1297	1282	1269
		F	0.40	0.45	0.48	0.49	0.51	0.52	0.53	0.54	0.55	0.56	0.57	0.57	0.58	0.59	0.59
	18	q	2120	1881	1722	1660	1608	1562	1523	1487	1456	1428	1403	1380	1360	1341	1323
		F	0.31	0.35	0.38	0.39	0.41	0.42	0.43	0.44	0.45	0.46	0.46	0.47	0.48	0.49	0.49
16	q	2389	2090	1890	1814	1748	1691	1641	1597	1558	1523	1492	1463	1438	1414	1392	
	F	0.24	0.28	0.31	0.32	0.33	0.34	0.36	0.36	0.37	0.38	0.39	0.40	0.41	0.41	0.42	
36/7	22	q	2064	1852	1711	1656	1609	1569	1534	1502	1475	1450	1427	1407	1389	1372	1357
		F	0.40	0.45	0.48	0.50	0.51	0.53	0.54	0.55	0.56	0.57	0.58	0.59	0.59	0.60	0.61
	20	q	2245	1990	1820	1755	1699	1650	1608	1570	1537	1507	1480	1456	1434	1414	1395
		F	0.34	0.38	0.41	0.43	0.44	0.46	0.47	0.48	0.49	0.50	0.51	0.52	0.52	0.53	0.54
	18	q	2622	2283	2057	1970	1895	1830	1774	1724	1680	1640	1604	1572	1542	1516	1491
		F	0.25	0.29	0.32	0.33	0.34	0.36	0.37	0.38	0.39	0.40	0.41	0.41	0.42	0.43	0.44
16	q	3017	2593	2310	2201	2107	2027	1956	1893	1838	1788	1743	1703	1666	1633	1602	
	F	0.19	0.22	0.25	0.26	0.28	0.29	0.30	0.31	0.32	0.33	0.33	0.34	0.35	0.36	0.36	

See footnotes on page 39.

PLB™ or B FORMLOK™

- 4 in. TOTAL SLAB DEPTH
- Light Weight Concrete
- 1 Hour Fire Rating

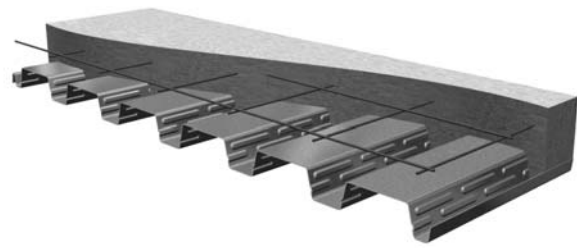

Maximum Unshored Clear Span (ft-in.)

Deck Gage	Number of Deck Spans		
	1	2	3
22	6'-9"	7'-11"	8'-0"
20	8'-1"	9'-5"	9'-7"
18	9'-2"	11'-1"	11'-4"
16	9'-10"	12'-3"	11'-11"

Shoring is required for spans greater than those shown above. See Footnote 1 on page 39 for required bearing.

Concrete Properties

Density (pcf)	Uniform Weight (psf)	Uniform Volume (yd ³ /100 ft ²)	Compressive Strength, f' _c (psi)
110	27.8	0.936	3000

Notes:

1. Volumes and weights do not include allowance for deflection.
2. Weights are for concrete only and do not include weight of steel deck.
3. Total slab depth is nominal depth from top of concrete to bottom of steel deck.

Allowable Superimposed Loads (psf)

Deck Gage	Number of Deck Spans	Span (ft-in.)															
		4'-0"	5'-0"	6'-0"	6'-6"	7'-0"	7'-6"	8'-0"	8'-6"	9'-0"	9'-6"	10'-0"	10'-6"	11'-0"	11'-6"	12'-0"	
22	1	400	400	303	265	206	181	160	142	126	113	101	91	82	75	67	
	2	400	400	303	265	234	209	160	142	126	113	101	91	82	75	67	
	3	400	400	303	265	234	209	188	142	126	113	101	91	82	75	67	
20	1	400	400	318	279	246	220	197	150	134	120	108	97	88	79	72	
	2	400	400	318	279	246	220	197	178	162	120	108	97	88	79	72	
	3	400	400	318	279	246	220	197	178	162	148	108	97	88	79	72	
18	1	400	400	344	301	266	237	213	192	175	131	118	106	96	87	79	
	2	400	400	344	301	266	237	213	192	175	160	147	135	125	87	79	
	3	400	400	344	301	266	237	213	192	175	160	147	135	125	87	79	
16	1	400	400	342	300	265	236	212	192	174	159	117	105	95	86	78	
	2	400	400	342	300	265	236	212	192	174	159	146	135	125	116	108	
	3	400	400	342	300	265	236	212	192	174	159	146	135	125	116	78	

See footnotes on page 39.

Shoring required in shaded areas to right of heavy line.

Allowable Diaphragm Shear Strengths, q (plf) and Flexibility Factors, F (in./lb. x 10⁶)

Attachment Pattern	Deck Gage	Span (ft-in.)															
		4'-0"	5'-0"	6'-0"	6'-6"	7'-0"	7'-6"	8'-0"	8'-6"	9'-0"	9'-6"	10'-0"	10'-6"	11'-0"	11'-6"	12'-0"	
36/4	22	q	1908	1759	1659	1621	1588	1559	1534	1512	1493	1475	1460	1445	1433	1421	1410
		F	0.43	0.47	0.50	0.51	0.52	0.53	0.54	0.55	0.55	0.56	0.56	0.57	0.58	0.58	0.58
	20	q	2026	1846	1726	1680	1641	1607	1577	1551	1527	1506	1487	1470	1455	1440	1427
		F	0.37	0.41	0.44	0.45	0.46	0.47	0.48	0.49	0.49	0.50	0.51	0.51	0.52	0.52	0.53
	18	q	2278	2039	1880	1818	1766	1720	1681	1645	1614	1586	1561	1538	1518	1499	1481
		F	0.29	0.32	0.35	0.36	0.37	0.38	0.39	0.40	0.40	0.41	0.42	0.42	0.43	0.44	0.44
16	q	2547	2248	2048	1972	1906	1849	1799	1755	1716	1681	1650	1621	1596	1572	1550	
	F	0.23	0.26	0.28	0.30	0.31	0.32	0.32	0.33	0.34	0.35	0.35	0.36	0.37	0.37	0.38	
36/7	22	q	2222	2010	1869	1814	1767	1727	1692	1660	1633	1608	1585	1565	1547	1530	1515
		F	0.37	0.41	0.44	0.45	0.47	0.48	0.49	0.50	0.50	0.51	0.52	0.53	0.53	0.54	0.54
	20	q	2403	2148	1978	1913	1857	1808	1766	1728	1695	1665	1638	1614	1592	1572	1553
		F	0.31	0.35	0.38	0.39	0.41	0.42	0.43	0.44	0.44	0.45	0.46	0.47	0.47	0.48	0.48
	18	q	2780	2441	2215	2128	2053	1988	1932	1882	1838	1798	1762	1730	1700	1674	1649
		F	0.23	0.27	0.29	0.31	0.32	0.33	0.34	0.35	0.35	0.36	0.37	0.38	0.38	0.39	0.40
	16	q	3175	2751	2468	2359	2265	2185	2114	2051	1996	1946	1901	1861	1824	1791	1760
		F	0.18	0.21	0.24	0.25	0.26	0.27	0.28	0.28	0.29	0.30	0.31	0.31	0.32	0.33	0.33

See footnotes on page 39.

PLB™ or B FORMLOK™

- 4¾ in. TOTAL SLAB DEPTH
- Light Weight Concrete
- 2 Hour Fire Rating

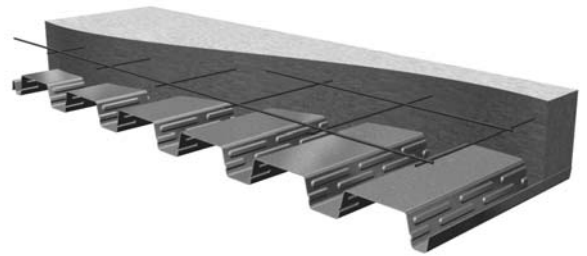

Maximum Unshored Clear Span (ft-in.)

Deck Gage	Number of Deck Spans		
	1	2	3
22	6'-4"	7'-5"	7'-6"
20	7'-7"	8'-10"	8'-11"
18	8'-8"	10'-5"	10'-8"
16	9'-3"	11'-6"	11'-5"

Shoring is required for spans greater than those shown above. See Footnote 1 on page 39 for required bearing.

Concrete Properties

Density (pcf)	Uniform Weight (psf)	Uniform Volume (yd³/100 ft²)	Compressive Strength, f'c (psi)
110	34.7	1.167	3000

Notes:

1. Volumes and weights do not include allowance for deflection.
2. Weights are for concrete only and do not include weight of steel deck.
3. Total slab depth is nominal depth from top of concrete to bottom of steel deck.

Allowable Superimposed Loads (psf)

Deck Gage	Number of Deck Spans	Span (ft-in.)															
		4'-0"	5'-0"	6'-0"	6'-6"	7'-0"	7'-6"	8'-0"	8'-6"	9'-0"	9'-6"	10'-0"	10'-6"	11'-0"	11'-6"	12'-0"	
22	1	400	400	370	290	253	221	195	173	155	138	124	112	101	91	83	
	2	400	400	370	324	286	221	195	173	155	138	124	112	101	91	83	
	3	400	400	370	324	286	255	195	173	155	138	124	112	101	91	83	
20	1	400	400	389	340	301	268	206	183	163	146	132	119	107	97	88	
	2	400	400	389	340	301	268	241	217	163	146	132	119	107	97	88	
	3	400	400	389	340	301	268	241	217	163	146	132	119	107	97	88	
18	1	400	400	400	366	324	289	259	234	178	160	144	130	118	107	97	
	2	400	400	400	366	324	289	259	234	213	195	179	130	118	107	97	
	3	400	400	400	366	324	289	259	234	213	195	179	165	118	107	97	
16	1	400	400	400	364	321	287	257	233	211	158	142	128	116	105	96	
	2	400	400	400	364	321	287	257	233	211	193	177	164	151	141	96	
	3	400	400	400	364	321	287	257	233	211	193	177	164	151	105	96	

See footnotes on page 39.

Shoring required in shaded areas to right of heavy line.

Allowable Diaphragm Shear Strengths, q (plf) and Flexibility Factors, F (in./lb. x 10⁶)

Attachment Pattern	Deck Gage	Span (ft-in.)															
		4'-0"	5'-0"	6'-0"	6'-6"	7'-0"	7'-6"	8'-0"	8'-6"	9'-0"	9'-6"	10'-0"	10'-6"	11'-0"	11'-6"	12'-0"	
36/4	22	q	2145	1996	1896	1858	1825	1796	1771	1749	1730	1712	1697	1682	1669	1658	1647
		F	0.38	0.41	0.43	0.44	0.45	0.46	0.47	0.47	0.48	0.48	0.49	0.49	0.49	0.50	0.50
	20	q	2263	2083	1963	1917	1878	1844	1814	1788	1764	1743	1724	1707	1692	1677	1664
		F	0.33	0.36	0.38	0.39	0.40	0.41	0.41	0.42	0.43	0.43	0.44	0.44	0.44	0.45	0.45
	18	q	2515	2276	2117	2055	2003	1957	1917	1882	1851	1823	1798	1775	1755	1736	1718
		F	0.26	0.29	0.31	0.32	0.33	0.33	0.34	0.35	0.35	0.36	0.36	0.37	0.37	0.38	0.38
16	q	2784	2485	2285	2209	2143	2086	2036	1992	1953	1918	1887	1858	1833	1809	1787	
	F	0.21	0.23	0.26	0.26	0.27	0.28	0.29	0.29	0.30	0.30	0.31	0.31	0.32	0.32	0.33	
36/7	22	q	2459	2247	2105	2051	2004	1964	1929	1897	1870	1845	1822	1802	1784	1767	1752
		F	0.34	0.37	0.39	0.40	0.41	0.42	0.43	0.43	0.44	0.45	0.45	0.46	0.46	0.47	0.47
	20	q	2640	2385	2215	2150	2094	2045	2003	1965	1932	1902	1875	1851	1829	1809	1790
		F	0.28	0.32	0.34	0.35	0.36	0.37	0.38	0.38	0.39	0.40	0.40	0.41	0.41	0.42	0.42
	18	q	3017	2678	2452	2365	2290	2225	2169	2119	2074	2035	1999	1967	1937	1911	1886
		F	0.22	0.24	0.27	0.28	0.28	0.29	0.30	0.31	0.31	0.32	0.33	0.33	0.34	0.34	0.35
16	q	3412	2988	2705	2596	2502	2421	2351	2288	2233	2183	2138	2098	2061	2028	1997	
	F	0.17	0.20	0.22	0.22	0.23	0.24	0.25	0.25	0.26	0.27	0.27	0.28	0.28	0.29	0.29	

See footnotes on page 39.

PLB™ or B FORMLOK™

- 5¾ in. TOTAL SLAB DEPTH
- Light Weight Concrete
- 3 Hour Fire Rating

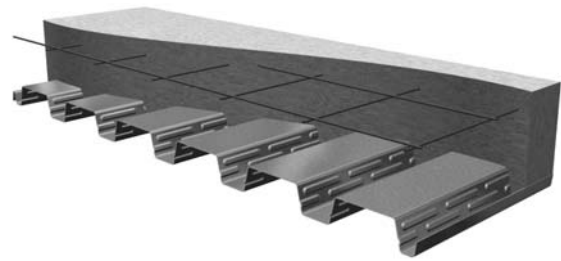

Maximum Unshored Clear Span (ft-in.)

Deck Gage	Number of Deck Spans		
	1	2	3
22	5'-11"	6'-11"	7'-0"
20	7'-1"	8'-3"	8'-4"
18	8'-1"	9'-8"	10'-0"
16	8'-8"	10'-9"	10'-8"

Shoring is required for spans greater than those shown above. See Footnote 1 on page 39 for required bearing.

Concrete Properties

Density (pcf)	Uniform Weight (psf)	Uniform Volume (yd ³ /100 ft ²)	Compressive Strength, f' _c (psi)
110	43.8	1.476	3000

Notes:

1. Volumes and weights do not include allowance for deflection.
2. Weights are for concrete only and do not include weight of steel deck.
3. Total slab depth is nominal depth from top of concrete to bottom of steel deck.

Allowable Superimposed Loads (psf)

Deck Gage	Number of Deck Spans	Span (ft-in.)														
		4'-0"	5'-0"	6'-0"	6'-6"	7'-0"	7'-6"	8'-0"	8'-6"	9'-0"	9'-6"	10'-0"	10'-6"	11'-0"	11'-6"	12'-0"
22	1	400	400	400	364	317	278	245	218	194	174	156	141	127	115	104
	2	400	400	400	400	317	278	245	218	194	174	156	141	127	115	104
	3	400	400	400	400	358	278	245	218	194	174	156	141	127	115	104
20	1	400	400	400	400	376	293	259	230	205	184	165	149	135	122	111
	2	400	400	400	400	376	335	301	230	205	184	165	149	135	122	111
	3	400	400	400	400	376	335	301	230	205	184	165	149	135	122	111
18	1	400	400	400	400	400	361	324	250	223	201	181	163	148	134	122
	2	400	400	400	400	400	361	324	293	266	243	181	163	148	134	122
	3	400	400	400	400	400	361	324	293	266	243	223	163	148	134	122
16	1	400	400	400	400	400	358	321	290	221	198	178	161	146	132	120
	2	400	400	400	400	400	358	321	290	264	241	221	204	146	132	120
	3	400	400	400	400	400	358	321	290	264	241	221	204	146	132	120

See footnotes on page 39.

Shoring required in shaded areas to right of heavy line.

Allowable Diaphragm Shear Strengths, q (plf) and Flexibility Factors, F (in./lb. x 10⁶)

Attachment Pattern	Deck Gage		Span (ft-in.)														
			4'-0"	5'-0"	6'-0"	6'-6"	7'-0"	7'-6"	8'-0"	8'-6"	9'-0"	9'-6"	10'-0"	10'-6"	11'-0"	11'-6"	12'-0"
36/4	22	q	2461	2311	2212	2174	2141	2112	2087	2065	2046	2028	2013	1998	1985	1974	1963
		F	0.33	0.36	0.37	0.38	0.39	0.39	0.39	0.40	0.40	0.41	0.41	0.41	0.42	0.42	0.42
	20	q	2578	2399	2279	2233	2194	2160	2130	2104	2080	2059	2040	2023	2008	1993	1980
		F	0.29	0.31	0.33	0.34	0.34	0.35	0.35	0.36	0.36	0.37	0.37	0.37	0.37	0.38	0.38
	18	q	2831	2592	2433	2371	2319	2273	2233	2198	2167	2139	2114	2091	2071	2052	2034
		F	0.23	0.25	0.27	0.27	0.28	0.29	0.29	0.30	0.30	0.30	0.31	0.31	0.31	0.32	0.32
16	q	3099	2801	2601	2525	2459	2402	2352	2308	2269	2234	2203	2174	2149	2125	2103	
	F	0.19	0.21	0.22	0.23	0.24	0.24	0.25	0.25	0.26	0.26	0.26	0.27	0.27	0.27	0.28	
36/7	22	q	2775	2563	2421	2367	2320	2280	2245	2213	2186	2161	2138	2118	2100	2083	2068
		F	0.30	0.32	0.34	0.35	0.36	0.36	0.37	0.37	0.38	0.38	0.39	0.39	0.39	0.40	0.40
	20	q	2956	2701	2531	2466	2410	2361	2319	2281	2248	2218	2191	2167	2145	2125	2106
		F	0.25	0.28	0.30	0.31	0.31	0.32	0.32	0.33	0.33	0.34	0.34	0.35	0.35	0.35	0.36
	18	q	3333	2994	2768	2681	2606	2541	2485	2435	2390	2351	2315	2283	2253	2226	2202
		F	0.20	0.22	0.24	0.24	0.25	0.26	0.26	0.27	0.27	0.28	0.28	0.29	0.29	0.29	0.30
	16	q	3728	3304	3021	2912	2818	2737	2667	2604	2549	2499	2454	2414	2377	2344	2313
		F	0.16	0.18	0.19	0.20	0.21	0.21	0.22	0.22	0.23	0.23	0.24	0.24	0.25	0.25	0.25

See footnotes on page 39.

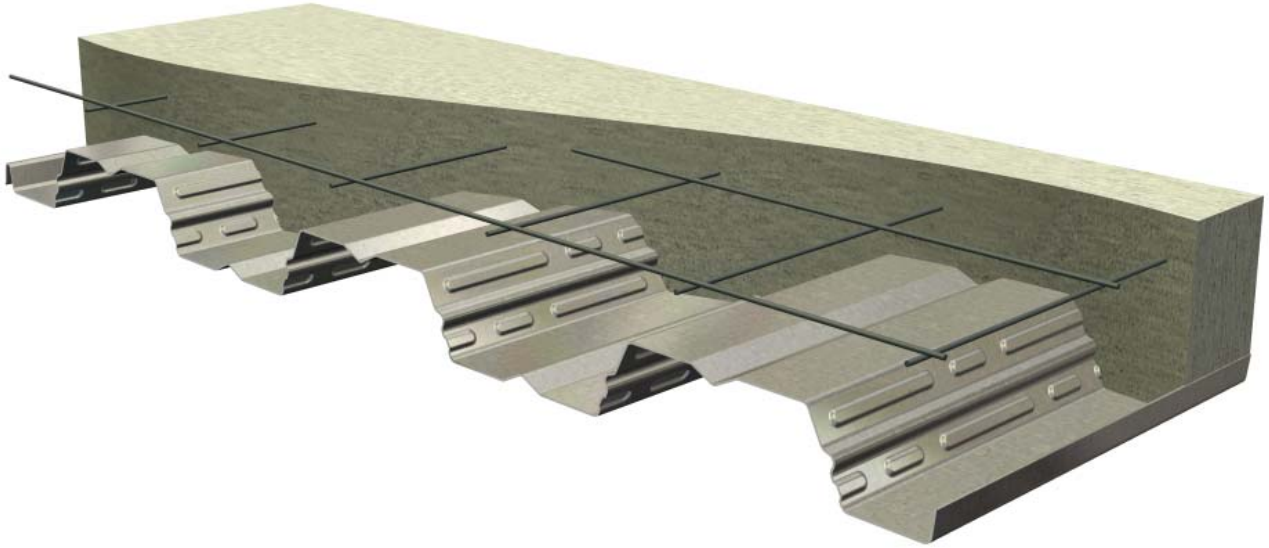

PLW2™ FORMLOK™ and W2 FORMLOK™

PLW2™ AND W2 FORMLOK™ CONTENTS

Section Properties	50
PLW2™ and W2 FORMLOK™ Tables	52-60
4 in. Total Slab Depth Normal Weight Concrete	52
4½ in. Total Slab Depth Normal Weight Concrete	53
5 in. Total Slab Depth Normal Weight Concrete	54
5½ in. Total Slab Depth Normal Weight Concrete	55
6½ in. Total Slab Depth Normal Weight Concrete	56
4 in. Total Slab Depth Light Weight Concrete	57
4½ in. Total Slab Depth Light Weight Concrete	58
5¼ in. Total Slab Depth Light Weight Concrete	59
6¼ in. Total Slab Depth Light Weight Concrete	60
PLW2™ and W2 FORMLOK™ without Concrete Fill	61-65
Allowable Uniform Load Tables	61-63
PLW2 FORMLOK Diaphragm Tables	64
W2 FORMLOK Diaphragm Tables	65

PLW2™ or W2 FORMLOK™

- 2 in. Deep FORMLOK Deck
- Phosphatized/Painted or Galvanized
- PLW2 FORMLOK used with PunchLok II System
- W2 FORMLOK used with TSWs or BPs
- W2 FORMLOK-SS used with Screws

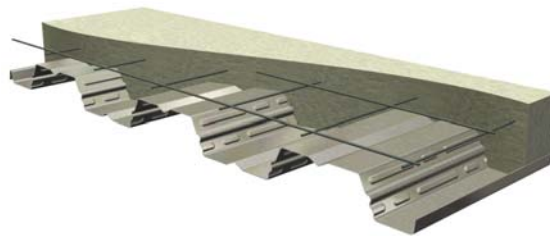

Dimensions

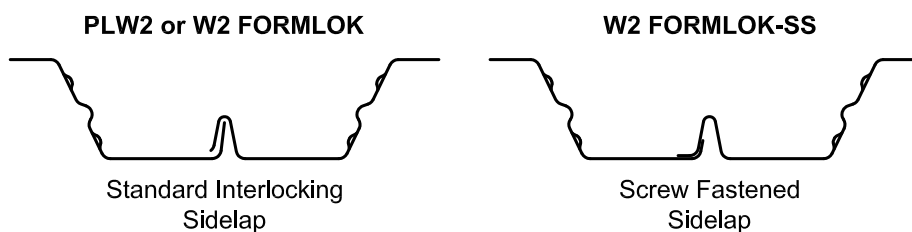
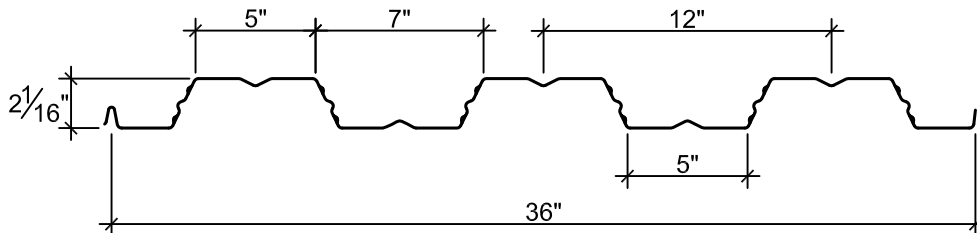

Deck Weight and Section Properties

Gage	Weight		I_d for Deflection		Moment		Allowable Reactions per ft of Width (lb) due to Web Crippling									
	Galv (psf)	Painted (psf)	Single Span (in. ⁴ /ft)	Multi Span (in. ⁴ /ft)	+ S_{eff} (in. ³ /ft)	- S_{eff} (in. ³ /ft)	One Flange Loading				Two Flange Loading					
							End Bearing Length		Interior Bearing Length		End Bearing Length		Interior Bearing Length			
							2"	3"	4"	4"	6"	2"	3"	4"	4"	6"
22	1.8	1.7	0.340	0.340	0.246	0.256	412	475	527	793	911	405	454	495	956	1108
21	2.0	1.9	0.381	0.381	0.283	0.294	492	565	626	945	1084	499	557	607	1148	1329
20	2.1	2.0	0.422	0.422	0.323	0.333	577	661	732	1109	1269	602	671	729	1356	1566
19	2.4	2.3	0.503	0.503	0.405	0.415	765	874	966	1472	1678	836	928	1006	1818	2092
18	2.7	2.6	0.564	0.564	0.471	0.481	940	1071	1182	1808	2056	1058	1172	1268	2247	2580
16	3.3	3.2	0.707	0.707	0.623	0.638	1424	1613	1773	2738	3097	1697	1868	2013	3441	3931

- Notes:**
1. Section properties are based on $F_y = 50,000$ psi.
 2. I_d is for deflection due to uniform loads.
 3. S_{eff} (+ or -) is the effective section modulus.
 4. Allowable (ASD) reactions are based on web crippling, per AISI S100 Section C3.4, where $\Omega_w = 1.70$ for end bearing and 1.75 for interior bearing. Nominal reactions may be determined by multiplying the table values by Ω_w . LRFD reactions may be determined by multiplying nominal reactions by $\phi_w = 0.9$ for end reactions and 0.85 for interior reactions.

Attachment Patterns to Supports



Note: ● indicates location of arc spot weld, power actuated fastener, or screw as indicated in the load tables.

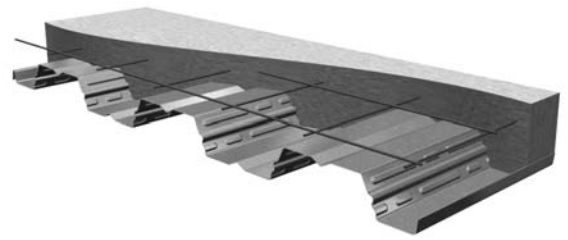

Footnotes for Maximum Unshored Clear Span, Allowable Superimposed Loads, and Allowable Diaphragm Shear Strength Tables

- Shoring calculations are based on the following:
 - Deck supporting dead load of concrete plus 20 psf uniform construction load or 150 pound concentrated construction live load for flexure. 4 psf is added for normal weight concrete and 3 psf is added for light weight concrete to account for ponding due to deck deflection between support members.
 - Dead load deflection limited to L/180 of span length, not to exceed 3/4".
 - Minimum end bearing of 2" for all gages and minimum interior bearing of 2" for 16, 18, and 19 gage. Minimum interior bearing varies from 2" to 5.25" for 20, 21, and 22 gage, depending on deck gage and slab thickness. Required bearing should be determined based on allowable reactions shown on page 50.
- Concrete fill to have minimum 28-day compressive strength $f'_c = 3,000$ psi.
- Total slab depth is nominal depth from top of concrete to bottom of steel deck.
- Shoring is required at midspan for allowable superimposed loads in the shaded area to the right of the heavy line.
- Nominal diaphragm shear strengths may be determined by multiplying the tabulated strengths by $\Omega = 3.0$. LRFD diaphragm shear strength may be determined by multiplying nominal diaphragm shear strength by $\phi = 0.55$.
- PLW2-36 and W2-36 FORMLOK decks with structural concrete have a Flexibility Factor of $F < 1$.
- To obtain allowable diaphragm shear strengths using mechanical fasteners, multiply the tabulated strengths by the appropriate adjustment factor, A_q listed in the following table.

Attachment Pattern	Adjustment Factor	Total Slab Depth (in.)								
		Normal Weight Concrete					Light Weight Concrete			
		4	4½	5	5½	6½	4	4½	5¼	6¼
36/3	A_{q3}	0.77	0.68	0.60	0.54	0.45	0.65	0.71	0.74	0.63
36/4	A_{q4}	0.67	0.73	0.75	0.68	0.57	0.56	0.62	0.69	0.76

Notes:

- Mechanical fastener attachment patterns are to match the listed attachment patterns for welds.
- Applicable mechanical fasteners are limited to the following: Hilti Fasteners, Pneutek Fasteners and SDI Recognized #12 or #14 Screws produced by Buildex, Elco, Hilti or Simpson Strong-Tie. Comply with minimum and maximum substrate thickness requirements for applicable mechanical fasteners. Note that these adjustment factors are based on the most conservative value for all listed connectors.
- Nominal diaphragm shear strengths for mechanically fastened FORMLOK slabs may be determined by multiplying the adjusted table values by $\Omega = 3.25$. LRFD diaphragm shear values for mechanically fastened FORMLOK slabs may be determined by multiplying the adjusted nominal values by $\phi = 0.50$.
- Consult fastener manufacturer for applicable fire-resistance assembly ratings where mechanical fasteners are required.

Footnotes for Allowable Uniform Load Tables for Deck without Concrete Fill

- Stress = Allowable uniform load based on maximum allowable flexural stress in deck.
- L/360, L240 or L/180 = Uniform load which produces selected deflection in deck.
- The symbol ♦♦♦ indicates allowable uniform load based on deflection exceeds allowable uniform load based on stress.
- Nominal uniform loads governed by stress may be determined by multiplying the allowable loads in the table by $\Omega_b = 1.67$. LRFD loads may be determined by multiplying nominal loads by $\phi_b = 0.95$.

Footnotes for Diaphragm Shear Strength and Flexibility Factor Tables for Deck without Concrete Fill

- VSC2 = Verco Sidelap Connection 2; BP = Button Punch; TSW = Top Seam Weld. Sidelap connections are not required at support locations.
- The end dimension to the first and last sidelap connection within each span is to be no more than one-half of specified sidelap spacing.
- R is the ratio of vertical span (L_V) of the deck to the length (L_S) of the deck sheet: $R = L_V / L_S$.
- Interpolation of diaphragm shear strength between adjacent spans or sidelap spacings is permissible. For interpolation of the diaphragm flexibility factor between adjacent spans, use the flexibility factor for the closest adjacent span length.
- Interpolation of diaphragm shear strengths for sidelap fasteners placed at spacings other than those in the table should be based on the number of sidelap fasteners in each span.
- The allowable diaphragm shear strengths in the tables utilize a factor of safety, $\Omega = 3.0$ (limited by connections), with the exception of the shaded table strengths, which utilize a factor of safety of $\Omega = 2.0$ (limited by panel buckling).

PLW2™ or W2 FORMLOK™

- 4 in. TOTAL SLAB DEPTH
- Normal Weight Concrete

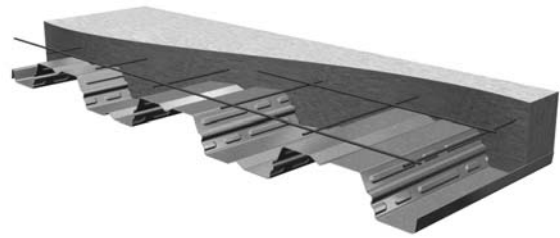

Maximum Unshored Clear Span (ft-in.)

Deck Gage	Number of Deck Spans		
	1	2	3
22	7'-9"	9'-0"	9'-2"
21	8'-6"	9'-8"	10'-0"
20	9'-3"	10'-3"	10'-8"
19	10'-0"	11'-5"	11'-10"
18	10'-5"	12'-3"	12'-5"
16	11'-2"	13'-11"	13'-1"

Shoring is required for spans greater than those shown above. See Footnote 1 on page 51 for required bearing.

Concrete Properties

Density (pcf)	Uniform Weight (psf)	Uniform Volume (yd ³ /100 ft ²)	Compressive Strength, f' _c (psi)
145	36.3	0.926	3000

Notes:

1. Volumes and weights do not include allowance for deflection.
2. Weights are for concrete only and do not include weight of steel deck.
3. Total slab depth is nominal depth from top of concrete to bottom of steel deck.

Allowable Superimposed Loads (psf)

Deck Gage	Number of Deck Spans	Span (ft-in.)														
		6'-0"	7'-0"	7'-6"	8'-0"	8'-6"	9'-0"	9'-6"	10'-0"	10'-6"	11'-0"	11'-6"	12'-0"	12'-6"	13'-0"	14'-0"
22	1	337	261	232	172	152	135	120	107	96	86	78	70	63	57	46
	2	337	261	232	209	189	171	120	107	96	86	78	70	63	57	46
	3	337	261	232	209	189	171	120	107	96	86	78	70	63	57	46
21	1	377	292	260	234	211	155	139	125	112	101	91	82	75	68	55
	2	377	292	260	234	211	192	175	125	112	101	91	82	75	68	55
	3	377	292	260	234	211	192	175	161	112	101	91	82	75	68	55
20	1	400	324	288	259	234	213	158	142	128	116	105	95	86	79	65
	2	400	324	288	259	234	213	195	179	128	116	105	95	86	79	65
	3	400	324	288	259	234	213	195	179	165	116	105	95	86	79	65
19	1	400	389	347	311	275	242	214	190	161	146	133	121	110	99	81
	2	400	389	347	311	275	242	214	190	169	152	133	121	110	99	81
	3	400	389	347	311	275	242	214	190	169	152	136	121	110	99	81
18	1	400	400	386	335	293	258	229	203	181	162	146	131	118	105	84
	2	400	400	386	335	293	258	229	203	181	162	146	131	118	105	84
	3	400	400	386	335	293	258	229	203	181	162	146	131	118	105	84
16	1	400	400	396	356	322	292	261	233	208	187	157	143	131	116	93
	2	400	400	396	356	322	292	261	233	208	187	168	148	131	116	93
	3	400	400	396	356	322	292	261	233	208	187	168	148	131	116	93

See footnotes on page 51.

Shoring required in shaded areas to right of heavy line.

Allowable Diaphragm Shear Strengths, q (plf) and Flexibility Factors, F (in./lb. x 10⁶)

Attachment Pattern	Deck Gage	Span (ft-in.)															
		6'-0"	7'-0"	7'-6"	8'-0"	8'-6"	9'-0"	9'-6"	10'-0"	10'-6"	11'-0"	11'-6"	12'-0"	12'-6"	13'-0"	14'-0"	
36/3	22	q	1674	1635	1619	1606	1594	1583	1573	1565	1557	1550	1543	1537	1532	1527	1518
	21	q	1680	1637	1620	1605	1592	1580	1570	1560	1552	1544	1537	1530	1524	1519	1509
	20	q	1689	1643	1624	1608	1593	1580	1569	1559	1549	1541	1533	1526	1519	1513	1503
	19	q	1714	1659	1637	1618	1602	1587	1573	1561	1550	1540	1531	1523	1515	1508	1496
	18	q	1739	1678	1653	1632	1613	1596	1581	1568	1556	1545	1534	1525	1517	1509	1495
	16	q	1809	1733	1702	1675	1652	1631	1612	1595	1580	1566	1553	1541	1531	1521	1503
36/4	22	q	1834	1762	1734	1708	1686	1667	1649	1633	1619	1606	1594	1583	1573	1563	1547
	21	q	1867	1788	1756	1729	1704	1683	1663	1646	1630	1616	1602	1590	1579	1569	1551
	20	q	1902	1816	1781	1751	1725	1701	1680	1661	1643	1628	1613	1600	1588	1577	1557
	19	q	1977	1877	1836	1801	1770	1742	1718	1696	1675	1657	1640	1625	1611	1598	1575
	18	q	2044	1931	1886	1847	1812	1781	1753	1729	1706	1686	1667	1650	1634	1619	1593
	16	q	2212	2071	2015	1965	1922	1883	1848	1817	1789	1763	1740	1718	1698	1680	1647

See footnotes on page 51.

PLW2™ or W2 FORMLOK™

- 4½ in. TOTAL SLAB DEPTH
- Normal Weight Concrete

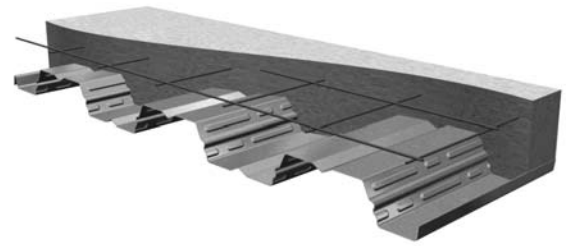

Maximum Unshored Clear Span (ft.-in.)

Deck Gage	Number of Deck Spans		
	1	2	3
22	7'-5"	8'-7"	8'-9"
21	8'-1"	9'-3"	9'-6"
20	8'-9"	9'-10"	10'-2"
19	9'-7"	10'-11"	11'-4"
18	10'-0"	11'-9"	12'-0"
16	10'-8"	13'-6"	12'-8"

Shoring is required for spans greater than those shown above. See Footnote 1 on page 51 for required bearing.

Concrete Properties

Density (pcf)	Uniform Weight (psf)	Uniform Volume (yd ³ /100 ft ²)	Compressive Strength, f' _c (psi)
145	42.3	1.080	3000

Notes:

1. Volumes and weights do not include allowance for deflection.
2. Weights are for concrete only and do not include weight of steel deck.
3. Total slab depth is nominal depth from top of concrete to bottom of steel deck.

Allowable Superimposed Loads (psf)

Deck Gage	Number of Deck Spans	Span (ft.-in.)															
		6'-0"	7'-0"	7'-6"	8'-0"	8'-6"	9'-0"	9'-6"	10'-0"	10'-6"	11'-0"	11'-6"	12'-0"	12'-6"	13'-0"	14'-0"	
22	1	380	294	220	194	171	152	135	121	108	97	87	78	70	63	51	
	2	380	294	262	235	213	152	135	121	108	97	87	78	70	63	51	
	3	380	294	262	235	213	152	135	121	108	97	87	78	70	63	51	
21	1	400	329	293	263	196	174	156	140	125	113	102	92	83	75	62	
	2	400	329	293	263	238	216	156	140	125	113	102	92	83	75	62	
	3	400	329	293	263	238	216	198	140	125	113	102	92	83	75	62	
20	1	400	364	324	291	263	198	177	159	143	130	117	106	97	88	73	
	2	400	364	324	291	263	239	219	159	143	130	117	106	97	88	73	
	3	400	364	324	291	263	239	219	201	143	130	117	106	97	88	73	
19	1	400	400	389	349	316	287	262	199	180	163	149	136	124	113	95	
	2	400	400	389	349	316	287	262	241	222	163	149	136	124	113	95	
	3	400	400	389	349	316	287	262	241	222	206	149	136	124	113	95	
18	1	400	400	400	399	361	328	300	275	211	192	176	161	147	135	115	
	2	400	400	400	399	361	328	300	275	254	235	210	161	147	135	115	
	3	400	400	400	399	361	328	300	275	254	235	210	185	147	135	115	
16	1	400	400	400	397	359	327	298	274	253	191	174	159	146	134	114	
	2	400	400	400	397	359	327	298	274	253	234	217	197	179	160	114	
	3	400	400	400	397	359	327	298	274	253	234	217	197	179	134	114	

See footnotes on page 51.

Shoring required in shaded areas to right of heavy line.

Allowable Diaphragm Shear Strengths, q (plf) and Flexibility Factors, F (in./lb. x 10⁶)

Attachment Pattern	Deck Gage	Span (ft.-in.)															
		6'-0"	7'-0"	7'-6"	8'-0"	8'-6"	9'-0"	9'-6"	10'-0"	10'-6"	11'-0"	11'-6"	12'-0"	12'-6"	13'-0"	14'-0"	
36/3	22	q	1913	1874	1858	1845	1833	1822	1812	1804	1796	1789	1782	1777	1771	1766	1757
	21	q	1919	1876	1859	1844	1831	1819	1809	1799	1791	1783	1776	1769	1763	1758	1748
	20	q	1928	1882	1863	1847	1832	1819	1808	1798	1788	1780	1772	1765	1758	1752	1742
	19	q	1953	1898	1877	1857	1841	1826	1812	1800	1789	1779	1770	1762	1754	1747	1735
	18	q	1978	1917	1892	1871	1852	1835	1820	1807	1795	1784	1774	1764	1756	1748	1734
	16	q	2048	1972	1941	1914	1891	1870	1851	1834	1819	1805	1792	1781	1770	1760	1742
36/4	22	q	2073	2001	1973	1947	1925	1906	1888	1872	1858	1845	1833	1822	1812	1802	1786
	21	q	2106	2027	1995	1968	1943	1922	1902	1885	1869	1855	1842	1829	1818	1808	1790
	20	q	2141	2055	2020	1990	1964	1940	1919	1900	1882	1867	1853	1839	1827	1816	1796
	19	q	2216	2116	2075	2040	2009	1982	1957	1935	1915	1896	1880	1864	1850	1837	1814
	18	q	2283	2170	2125	2086	2051	2020	1992	1968	1945	1925	1906	1889	1873	1859	1833
	16	q	2451	2310	2254	2204	2161	2122	2087	2056	2028	2002	1979	1957	1937	1919	1887

See footnotes on page 51.

PLW2™ or W2 FORMLOK™

- 5 in. TOTAL SLAB DEPTH
- Normal Weight Concrete

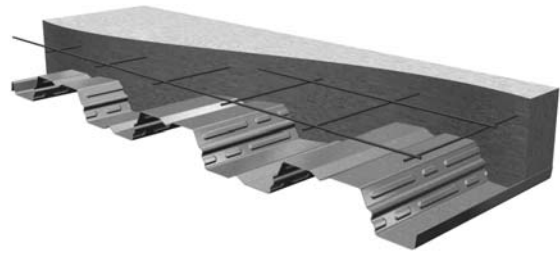

Maximum Unshored Clear Span (ft-in.)

Deck Gage	Number of Deck Spans		
	1	2	3
22	7'-1"	8'-3"	8'-4"
21	7'-9"	8'-10"	9'-2"
20	8'-5"	9'-5"	9'-9"
19	9'-3"	10'-6"	10'-10"
18	9'-7"	11'-3"	11'-8"
16	10'-4"	12'-11"	12'-4"

Concrete Properties

Density (pcf)	Uniform Weight (psf)	Uniform Volume (yd ³ /100 ft ²)	Compressive Strength, f _c (psi)
145	48.3	1.235	3000

Notes:

1. Volumes and weights do not include allowance for deflection.
2. Weights are for concrete only and do not include weight of steel deck.
3. Total slab depth is nominal depth from top of concrete to bottom of steel deck.

Shoring is required for spans greater than those shown above. See Footnote 1 on page 51 for required bearing.

Allowable Superimposed Loads (psf)

Deck Gage	Number of Deck Spans	Span (ft-in.)														
		6'-0"	7'-0"	7'-6"	8'-0"	8'-6"	9'-0"	9'-6"	10'-0"	10'-6"	11'-0"	11'-6"	12'-0"	12'-6"	13'-0"	14'-0"
22	1	400	329	246	216	191	169	151	135	120	108	97	87	78	70	57
	2	400	329	293	263	191	169	151	135	120	108	97	87	78	70	57
	3	400	329	293	263	191	169	151	135	120	108	97	87	78	70	57
21	1	400	367	328	247	219	195	174	156	140	126	114	103	93	84	69
	2	400	367	328	294	266	195	174	156	140	126	114	103	93	84	69
	3	400	367	328	294	266	242	174	156	140	126	114	103	93	84	69
20	1	400	400	363	326	247	221	198	178	160	145	131	119	108	98	81
	2	400	400	363	326	294	268	198	178	160	145	131	119	108	98	81
	3	400	400	363	326	294	268	245	178	160	145	131	119	108	98	81
19	1	400	400	400	390	353	321	246	222	201	182	166	151	138	126	106
	2	400	400	400	390	353	321	293	269	248	182	166	151	138	126	106
	3	400	400	400	390	353	321	293	269	248	182	166	151	138	126	106
18	1	400	400	400	400	400	366	334	259	235	214	196	179	164	151	128
	2	400	400	400	400	400	366	334	307	283	262	196	179	164	151	128
	3	400	400	400	400	400	366	334	307	283	262	243	179	164	151	128
16	1	400	400	400	400	400	364	332	305	233	212	194	177	162	149	126
	2	400	400	400	400	400	364	332	305	281	260	242	225	210	149	126
	3	400	400	400	400	400	364	332	305	281	260	242	225	162	149	126

See footnotes on page 51.

Shoring required in shaded areas to right of heavy line.

Allowable Diaphragm Shear Strengths, q (plf) and Flexibility Factors, F (in./lb. x 10⁶)

Attachment Pattern	Deck Gage	Span (ft-in.)															
		6'-0"	7'-0"	7'-6"	8'-0"	8'-6"	9'-0"	9'-6"	10'-0"	10'-6"	11'-0"	11'-6"	12'-0"	12'-6"	13'-0"	14'-0"	
36/3	22	q	2152	2113	2097	2084	2072	2061	2051	2043	2035	2028	2022	2016	2010	2005	1996
	21	q	2158	2116	2098	2083	2070	2058	2048	2038	2030	2022	2015	2009	2003	1997	1987
	20	q	2168	2121	2102	2086	2071	2059	2047	2037	2027	2019	2011	2004	1998	1992	1981
	19	q	2192	2137	2116	2097	2080	2065	2051	2039	2028	2019	2009	2001	1994	1987	1974
	18	q	2217	2156	2131	2110	2091	2074	2059	2046	2034	2023	2013	2003	1995	1987	1973
	16	q	2287	2211	2180	2154	2130	2109	2090	2073	2058	2044	2031	2020	2009	1999	1981
36/4	22	q	2312	2240	2212	2187	2164	2145	2127	2111	2097	2084	2072	2061	2051	2042	2025
	21	q	2345	2266	2234	2207	2182	2161	2141	2124	2108	2094	2081	2069	2058	2047	2029
	20	q	2380	2294	2259	2229	2203	2179	2158	2139	2122	2106	2092	2078	2066	2055	2035
	19	q	2455	2355	2314	2279	2248	2221	2196	2174	2154	2135	2119	2103	2089	2076	2053
	18	q	2522	2409	2364	2325	2290	2259	2232	2207	2184	2164	2145	2128	2112	2098	2072
	16	q	2691	2549	2493	2443	2400	2361	2326	2295	2267	2241	2218	2196	2176	2158	2126

See footnotes on page 51.

PLW2™ or W2 FORMLOK™

- 5½ in. TOTAL SLAB DEPTH
- Normal Weight Concrete
- 1 Hour Fire Rating

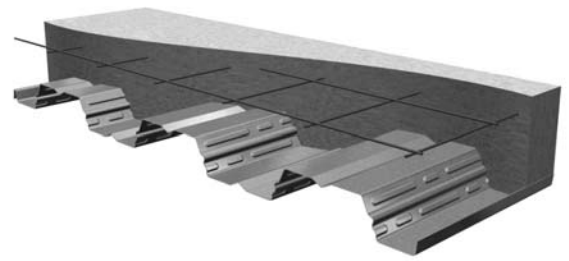

Maximum Unshored Clear Span (ft-in.)

Deck Gage	Number of Deck Spans		
	1	2	3
22	6'-10"	7'-11"	8'-0"
21	7'-5"	8'-6"	8'-9"
20	8'-1"	9'-0"	9'-4"
19	8'-11"	10'-1"	10'-5"
18	9'-3"	10'-10"	11'-2"
16	9'-11"	12'-5"	12'-0"

Shoring is required for spans greater than those shown above. See Footnote 1 on page 51 for required bearing.

Concrete Properties

Density (pcf)	Uniform Weight (psf)	Uniform Volume (yd ³ /100 ft ²)	Compressive Strength, f' _c (psi)
145	54.4	1.389	3000

Notes:

1. Volumes and weights do not include allowance for deflection.
2. Weights are for concrete only and do not include weight of steel deck.
3. Total slab depth is nominal depth from top of concrete to bottom of steel deck.

Allowable Superimposed Loads (psf)

Deck Gage	Number of Deck Spans	Span (ft-in.)														
		6'-0"	7'-0"	7'-6"	8'-0"	8'-6"	9'-0"	9'-6"	10'-0"	10'-6"	11'-0"	11'-6"	12'-0"	12'-6"	13'-0"	14'-0"
22	1	400	313	273	240	212	188	167	149	134	120	108	97	87	78	63
	2	400	365	325	240	212	188	167	149	134	120	108	97	87	78	63
	3	400	365	325	292	212	188	167	149	134	120	108	97	87	78	63
21	1	400	400	311	274	243	216	193	173	155	140	126	114	103	93	76
	2	400	400	364	326	295	216	193	173	155	140	126	114	103	93	76
	3	400	400	364	326	295	216	193	173	155	140	126	114	103	93	76
20	1	400	400	400	361	274	245	219	197	177	160	145	132	120	109	90
	2	400	400	400	361	327	297	219	197	177	160	145	132	120	109	90
	3	400	400	400	361	327	297	219	197	177	160	145	132	120	109	90
19	1	400	400	400	400	391	303	272	246	222	202	184	168	153	140	118
	2	400	400	400	400	391	355	325	298	222	202	184	168	153	140	118
	3	400	400	400	400	391	355	325	298	222	202	184	168	153	140	118
18	1	400	400	400	400	400	400	318	287	261	237	217	198	182	167	141
	2	400	400	400	400	400	400	370	340	314	237	217	198	182	167	141
	3	400	400	400	400	400	400	370	340	314	290	217	198	182	167	141
16	1	400	400	400	400	400	400	368	284	258	235	214	196	179	165	139
	2	400	400	400	400	400	400	368	338	311	288	267	249	179	165	139
	3	400	400	400	400	400	400	368	338	311	288	267	249	179	165	139

See footnotes on page 51.

Shoring required in shaded areas to right of heavy line.

Allowable Diaphragm Shear Strengths, q (plf) and Flexibility Factors, F (in./lb. x 10⁶)

Attachment Pattern	Deck Gage	Span (ft-in.)															
		6'-0"	7'-0"	7'-6"	8'-0"	8'-6"	9'-0"	9'-6"	10'-0"	10'-6"	11'-0"	11'-6"	12'-0"	12'-6"	13'-0"	14'-0"	
36/3	22	q	2391	2352	2336	2323	2311	2300	2291	2282	2274	2267	2261	2255	2249	2244	2235
	21	q	2397	2355	2337	2323	2309	2298	2287	2278	2269	2261	2254	2248	2242	2236	2226
	20	q	2407	2360	2341	2325	2310	2298	2286	2276	2267	2258	2250	2243	2237	2231	2220
	19	q	2431	2376	2355	2336	2319	2304	2290	2278	2268	2258	2249	2240	2233	2226	2213
	18	q	2456	2395	2370	2349	2330	2314	2299	2285	2273	2262	2252	2242	2234	2226	2212
	16	q	2527	2450	2419	2393	2369	2348	2329	2312	2297	2283	2270	2259	2248	2238	2220
36/4	22	q	2551	2480	2451	2426	2403	2384	2366	2350	2336	2323	2311	2300	2290	2281	2264
	21	q	2584	2505	2474	2446	2422	2400	2380	2363	2347	2333	2320	2308	2297	2286	2268
	20	q	2619	2533	2499	2468	2442	2418	2397	2378	2361	2345	2331	2318	2306	2294	2274
	19	q	2694	2594	2554	2518	2487	2460	2435	2413	2393	2374	2358	2342	2328	2315	2292
	18	q	2761	2648	2603	2564	2529	2498	2471	2446	2423	2403	2384	2367	2351	2337	2311
	16	q	2930	2788	2732	2682	2639	2600	2565	2534	2506	2480	2457	2435	2416	2397	2365

See footnotes on page 51.

PLW2™ or W2 FORMLOK™

- 6½ in. TOTAL SLAB DEPTH
- Normal Weight Concrete
- 2 Hour Fire Rating

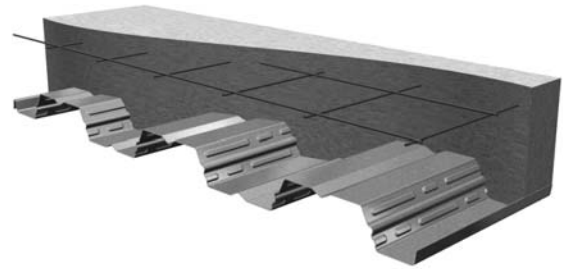

Maximum Unshored Clear Span (ft.-in.)

Deck Gage	Number of Deck Spans		
	1	2	3
22	6'-4"	7'-5"	7'-6"
21	6'-11"	7'-11"	8'-2"
20	7'-6"	8'-5"	8'-9"
19	8'-5"	9'-5"	9'-9"
18	8'-9"	10'-1"	10'-5"
16	9'-4"	11'-7"	11'-6"

Concrete Properties

Density (pcf)	Uniform Weight (psf)	Uniform Volume (yd ³ /100 ft ²)	Compressive Strength, f' _c (psi)
145	66.5	1.698	3000

Notes:

1. Volumes and weights do not include allowance for deflection.
2. Weights are for concrete only and do not include weight of steel deck.
3. Total slab depth is nominal depth from top of concrete to bottom of steel deck.

Shoring is required for spans greater than those shown above. See Footnote 1 on page 51 for required bearing.

Allowable Superimposed Loads (psf)

Deck Gage	Number of Deck Spans	Span (ft.-in.)															
		6'-0"	7'-0"	7'-6"	8'-0"	8'-6"	9'-0"	9'-6"	10'-0"	10'-6"	11'-0"	11'-6"	12'-0"	12'-6"	13'-0"	14'-0"	
22	1	400	377	329	290	256	227	202	180	161	145	130	117	105	94	76	
	2	400	400	329	290	256	227	202	180	161	145	130	117	105	94	76	
	3	400	400	392	290	256	227	202	180	161	145	130	117	105	94	76	
21	1	400	400	375	331	293	261	233	209	187	169	152	138	124	113	92	
	2	400	400	400	331	293	261	233	209	187	169	152	138	124	113	92	
	3	400	400	400	393	293	261	233	209	187	169	152	138	124	113	92	
20	1	400	400	400	372	331	295	264	237	214	193	175	159	144	131	109	
	2	400	400	400	400	331	295	264	237	214	193	175	159	144	131	109	
	3	400	400	400	400	393	295	264	237	214	193	175	159	144	131	109	
19	1	400	400	400	400	400	365	328	296	268	243	221	202	185	169	142	
	2	400	400	400	400	400	400	328	296	268	243	221	202	185	169	142	
	3	400	400	400	400	400	400	391	296	268	243	221	202	185	169	142	
18	1	400	400	400	400	400	400	400	382	346	314	286	261	239	219	201	170
	2	400	400	400	400	400	400	400	400	314	286	261	239	219	201	170	
	3	400	400	400	400	400	400	400	400	400	314	286	261	239	219	201	170
16	1	400	400	400	400	400	400	400	378	342	310	282	258	236	216	198	168
	2	400	400	400	400	400	400	400	400	400	374	346	321	236	216	198	168
	3	400	400	400	400	400	400	400	400	400	374	346	321	236	216	198	168

See footnotes on page 51.

Shoring required in shaded areas to right of heavy line.

Allowable Diaphragm Shear Strengths, q (plf) and Flexibility Factors, F (in./lb. x 10⁶)

Attachment Pattern	Deck Gage	Span (ft.-in.)															
		6'-0"	7'-0"	7'-6"	8'-0"	8'-6"	9'-0"	9'-6"	10'-0"	10'-6"	11'-0"	11'-6"	12'-0"	12'-6"	13'-0"	14'-0"	
36/3	22	q	2869	2830	2815	2801	2789	2778	2769	2760	2752	2745	2739	2733	2727	2722	2713
	21	q	2876	2833	2816	2801	2787	2776	2765	2756	2747	2739	2732	2726	2720	2714	2704
	20	q	2885	2838	2819	2803	2789	2776	2764	2754	2745	2736	2728	2721	2715	2709	2698
	19	q	2909	2855	2833	2814	2797	2782	2769	2757	2746	2736	2727	2718	2711	2704	2691
	18	q	2934	2873	2849	2827	2808	2792	2777	2763	2751	2740	2730	2721	2712	2704	2690
	16	q	3005	2928	2898	2871	2847	2826	2807	2790	2775	2761	2749	2737	2726	2716	2699
36/4	22	q	3029	2958	2929	2904	2882	2862	2844	2828	2814	2801	2789	2778	2768	2759	2742
	21	q	3062	2983	2952	2924	2900	2878	2859	2841	2825	2811	2798	2786	2775	2765	2746
	20	q	3097	3011	2977	2947	2920	2896	2875	2856	2839	2823	2809	2796	2784	2773	2753
	19	q	3172	3072	3032	2997	2966	2938	2913	2891	2871	2853	2836	2821	2807	2794	2770
	18	q	3239	3126	3081	3042	3007	2976	2949	2924	2901	2881	2862	2845	2829	2815	2789
	16	q	3408	3267	3210	3161	3117	3078	3044	3012	2984	2958	2935	2914	2894	2875	2843

See footnotes on page 51.

PLW2™ or W2 FORMLOK™

- 4 in. TOTAL SLAB DEPTH
- Light Weight Concrete

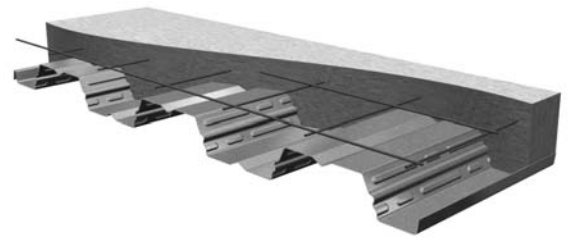

Maximum Unshored Clear Span (ft-in.)

Deck Gage	Number of Deck Spans		
	1	2	3
22	8'-6"	9'-10"	10'-1"
21	9'-4"	10'-6"	10'-11"
20	10'-2"	11'-2"	11'-7"
19	10'-11"	12'-5"	12'-11"
18	11'-4"	13'-5"	13'-3"
16	11'-11"	14'-10"	13'-11"

Shoring is required for spans greater than those shown above. See Footnote 1 on page 51 for required bearing.

Concrete Properties

Density (pcf)	Uniform Weight (psf)	Uniform Volume (yd ³ /100 ft ²)	Compressive Strength, f' _c (psi)
110	27.5	0.926	3000

Notes:

1. Volumes and weights do not include allowance for deflection.
2. Weights are for concrete only and do not include weight of steel deck.
3. Total slab depth is nominal depth from top of concrete to bottom of steel deck.

Allowable Superimposed Loads (psf)

Deck Gage	Number of Deck Spans	Span (ft-in.)														
		6'-0"	7'-0"	7'-6"	8'-0"	8'-6"	9'-0"	9'-6"	10'-0"	10'-6"	11'-0"	11'-6"	12'-0"	12'-6"	13'-0"	14'-0"
22	1	337	261	232	209	189	144	129	116	105	95	86	78	71	65	54
	2	337	261	232	209	189	171	157	116	105	95	86	78	71	65	54
	3	337	261	232	209	189	171	157	144	105	95	86	78	71	65	54
21	1	377	292	260	234	211	192	147	133	120	109	100	90	80	71	57
	2	377	292	260	234	211	192	175	156	134	109	100	90	80	71	57
	3	377	292	260	234	211	192	175	156	134	109	100	90	80	71	57
20	1	400	324	288	259	234	213	188	161	136	121	106	93	83	73	59
	2	400	324	288	259	234	213	188	161	139	121	106	93	83	73	59
	3	400	324	288	259	234	213	188	161	139	121	106	93	83	73	59
19	1	400	389	347	308	270	237	201	173	149	130	113	100	88	79	63
	2	400	389	347	308	270	237	201	173	149	130	113	100	88	79	63
	3	400	389	347	308	270	237	201	173	149	130	113	100	88	79	63
18	1	400	400	376	328	288	249	211	181	157	136	119	105	93	83	66
	2	400	400	376	328	288	249	211	181	157	136	119	105	93	83	66
	3	400	400	376	328	288	249	211	181	157	136	119	105	93	83	66
16	1	400	400	396	356	322	276	235	201	174	151	132	116	103	92	73
	2	400	400	396	356	322	276	235	201	174	151	132	116	103	92	73
	3	400	400	396	356	322	276	235	201	174	151	132	116	103	92	73

See footnotes on page 51.

Shoring required in shaded areas to right of heavy line.

Allowable Diaphragm Shear Strengths, q (plf) and Flexibility Factors, F (in./lb. x 10⁶)

Attachment Pattern	Deck Gage	Span (ft-in.)															
		6'-0"	7'-0"	7'-6"	8'-0"	8'-6"	9'-0"	9'-6"	10'-0"	10'-6"	11'-0"	11'-6"	12'-0"	12'-6"	13'-0"	14'-0"	
36/3	22	q	1349	1310	1295	1281	1269	1258	1249	1240	1232	1225	1219	1213	1208	1203	1194
	21	q	1356	1313	1296	1281	1268	1256	1245	1236	1227	1220	1212	1206	1200	1194	1185
	20	q	1365	1318	1300	1283	1269	1256	1244	1234	1225	1216	1209	1201	1195	1189	1178
	19	q	1389	1335	1313	1294	1277	1262	1249	1237	1226	1216	1207	1199	1191	1184	1171
	18	q	1414	1353	1329	1307	1289	1272	1257	1243	1231	1220	1210	1201	1192	1184	1170
	16	q	1485	1408	1378	1351	1327	1306	1287	1271	1255	1241	1229	1217	1206	1196	1179
36/4	22	q	1510	1438	1409	1384	1362	1342	1324	1309	1294	1281	1269	1258	1248	1239	1222
	21	q	1542	1463	1432	1404	1380	1358	1339	1321	1305	1291	1278	1266	1255	1245	1226
	20	q	1577	1491	1457	1427	1400	1376	1355	1336	1319	1303	1289	1276	1264	1253	1233
	19	q	1653	1552	1512	1477	1446	1418	1393	1371	1351	1333	1316	1301	1287	1274	1250
	18	q	1719	1607	1562	1522	1487	1457	1429	1404	1382	1361	1342	1325	1310	1295	1269
	16	q	1888	1747	1690	1641	1597	1558	1524	1493	1464	1439	1415	1394	1374	1356	1323

See footnotes on page 51.

PLW2™ or W2 FORMLOK™

- 4½ in. TOTAL SLAB DEPTH
- Light Weight Concrete
- 1 Hour Fire Rating

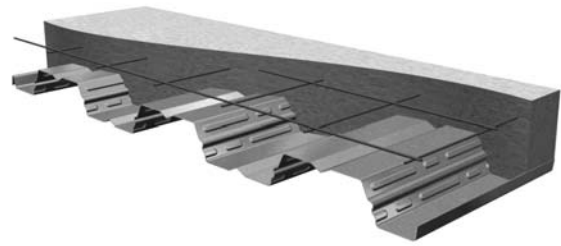

Maximum Unshored Clear Span (ft-in.)

Deck Gage	Number of Deck Spans		
	1	2	3
22	8'-1"	9'-5"	9'-7"
21	8'-11"	10'-1"	10'-5"
20	9'-8"	10'-9"	11'-1"
19	10'-6"	11'-11"	12'-4"
18	10'-10"	12'-10"	12'-10"
16	11'-7"	14'-5"	13'-6"

Shoring is required for spans greater than those shown above. See Footnote 1 on page 51 for required bearing.

Concrete Properties

Density (pcf)	Uniform Weight (psf)	Uniform Volume (yd ³ /100 ft ²)	Compressive Strength, f' _c (psi)
110	32.1	1.080	3000

Notes:

1. Volumes and weights do not include allowance for deflection.
2. Weights are for concrete only and do not include weight of steel deck.
3. Total slab depth is nominal depth from top of concrete to bottom of steel deck.

Allowable Superimposed Loads (psf)

Deck Gage	Number of Deck Spans	Span (ft-in.)															
		6'-0"	7'-0"	7'-6"	8'-0"	8'-6"	9'-0"	9'-6"	10'-0"	10'-6"	11'-0"	11'-6"	12'-0"	12'-6"	13'-0"	14'-0"	
22	1	380	294	262	235	181	161	145	130	118	106	97	88	80	73	61	
	2	380	294	262	235	213	193	145	130	118	106	97	88	80	73	61	
	3	380	294	262	235	213	193	177	130	118	106	97	88	80	73	61	
21	1	400	329	293	263	238	184	166	149	135	123	112	102	93	85	72	
	2	400	329	293	263	238	216	198	181	135	123	112	102	93	85	72	
	3	400	329	293	263	238	216	198	181	135	123	112	102	93	85	72	
20	1	400	364	324	291	263	239	219	169	153	139	127	116	106	98	81	
	2	400	364	324	291	263	239	219	201	185	139	127	116	106	98	81	
	3	400	364	324	291	263	239	219	201	185	167	127	116	106	98	81	
19	1	400	400	389	349	316	287	262	238	205	173	156	138	122	108	87	
	2	400	400	389	349	316	287	262	238	205	179	156	138	122	108	87	
	3	400	400	389	349	316	287	262	238	205	179	156	138	122	108	87	
18	1	400	400	400	399	361	327	291	250	216	188	164	144	128	114	91	
	2	400	400	400	399	361	327	291	250	216	188	164	144	128	114	91	
	3	400	400	400	399	361	327	291	250	216	188	164	144	128	114	91	
16	1	400	400	400	397	359	327	298	274	238	207	182	160	141	126	101	
	2	400	400	400	397	359	327	298	274	238	207	182	160	141	126	101	
	3	400	400	400	397	359	327	298	274	238	207	182	160	141	126	101	

See footnotes on page 51.

Shoring required in shaded areas to right of heavy line.

Allowable Diaphragm Shear Strengths, q (plf) and Flexibility Factors, F (in./lb. x 10⁶)

Attachment Pattern	Deck Gage	Span (ft-in.)															
		6'-0"	7'-0"	7'-6"	8'-0"	8'-6"	9'-0"	9'-6"	10'-0"	10'-6"	11'-0"	11'-6"	12'-0"	12'-6"	13'-0"	14'-0"	
36/3	22	q	1507	1468	1453	1439	1427	1416	1407	1398	1390	1383	1377	1371	1366	1360	1352
	21	q	1514	1471	1454	1439	1426	1414	1403	1394	1385	1378	1370	1364	1358	1352	1342
	20	q	1523	1476	1458	1441	1427	1414	1402	1392	1383	1374	1367	1359	1353	1347	1336
	19	q	1547	1493	1471	1452	1435	1420	1407	1395	1384	1374	1365	1357	1349	1342	1329
	18	q	1572	1511	1487	1465	1447	1430	1415	1401	1389	1378	1368	1359	1350	1342	1328
	16	q	1643	1566	1536	1509	1485	1464	1445	1429	1413	1399	1387	1375	1364	1354	1337
36/4	22	q	1668	1596	1567	1542	1520	1500	1482	1467	1452	1439	1427	1416	1406	1397	1380
	21	q	1700	1621	1590	1562	1538	1516	1497	1479	1463	1449	1436	1424	1413	1403	1384
	20	q	1735	1649	1615	1585	1558	1534	1513	1494	1477	1461	1447	1434	1422	1411	1391
	19	q	1811	1710	1670	1635	1604	1576	1551	1529	1509	1491	1474	1459	1445	1432	1408
	18	q	1877	1765	1720	1680	1645	1615	1587	1562	1540	1519	1500	1483	1468	1453	1427
	16	q	2046	1905	1848	1799	1755	1716	1682	1650	1622	1597	1573	1552	1532	1514	1481

See footnotes on page 51.

PLW2™ or W2 FORMLOK™

- 5¼ in. TOTAL SLAB DEPTH
- Light Weight Concrete
- 2 Hour Fire Rating

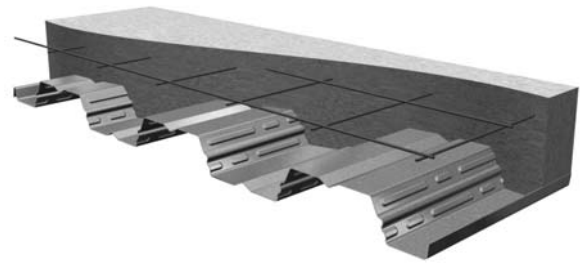

Maximum Unshored Clear Span (ft-in.)

Deck Gage	Number of Deck Spans		
	1	2	3
22	7'-8"	8'-11"	9'-0"
21	8'-5"	9'-6"	9'-10"
20	9'-1"	10'-2"	10'-6"
19	9'-11"	11'-3"	11'-8"
18	10'-3"	12'-2"	12'-4"
16	11'-0"	13'-10"	13'-0"

Shoring is required for spans greater than those shown above. See Footnote 1 on page 51 for required bearing.

Concrete Properties

Density (pcf)	Uniform Weight (psf)	Uniform Volume (yd ³ /100 ft ²)	Compressive Strength, f' _c (psi)
110	39.0	1.312	3000

Notes:

1. Volumes and weights do not include allowance for deflection.
2. Weights are for concrete only and do not include weight of steel deck.
3. Total slab depth is nominal depth from top of concrete to bottom of steel deck.

Allowable Superimposed Loads (psf)

Deck Gage	Number of Deck Spans	Span (ft-in.)															
		6'-0"	7'-0"	7'-6"	8'-0"	8'-6"	9'-0"	9'-6"	10'-0"	10'-6"	11'-0"	11'-6"	12'-0"	12'-6"	13'-0"	14'-0"	
22	1	400	347	309	240	213	190	171	154	139	125	114	103	94	86	71	
	2	400	347	309	277	251	190	171	154	139	125	114	103	94	86	71	
	3	400	347	309	277	251	228	171	154	139	125	114	103	94	86	71	
21	1	400	388	345	310	242	217	195	176	159	145	132	120	110	100	84	
	2	400	388	345	310	280	255	233	176	159	145	132	120	110	100	84	
	3	400	388	345	310	280	255	233	176	159	145	132	120	110	100	84	
20	1	400	400	382	343	310	282	220	199	180	164	150	137	125	115	97	
	2	400	400	382	343	310	282	258	237	180	164	150	137	125	115	97	
	3	400	400	382	343	310	282	258	237	218	164	150	137	125	115	97	
19	1	400	400	400	400	372	338	309	245	223	204	186	171	157	145	124	
	2	400	400	400	400	372	338	309	283	261	242	186	171	157	145	124	
	3	400	400	400	400	372	338	309	283	261	242	225	171	157	145	124	
18	1	400	400	400	400	400	385	352	323	260	237	218	200	184	170	139	
	2	400	400	400	400	400	385	352	323	298	276	251	221	184	170	139	
	3	400	400	400	400	400	385	352	323	298	276	251	221	184	170	139	
16	1	400	400	400	400	400	383	350	321	296	274	215	198	182	168	144	
	2	400	400	400	400	400	383	350	321	296	274	254	237	216	192	144	
	3	400	400	400	400	400	383	350	321	296	274	254	237	216	192	144	

See footnotes on page 51.

Shoring required in shaded areas to right of heavy line.

Allowable Diaphragm Shear Strengths, q (plf) and Flexibility Factors, F (in./lb. x 10⁶)

Attachment Pattern	Deck Gage	Span (ft-in.)															
		6'-0"	7'-0"	7'-6"	8'-0"	8'-6"	9'-0"	9'-6"	10'-0"	10'-6"	11'-0"	11'-6"	12'-0"	12'-6"	13'-0"	14'-0"	
36/3	22	q	1744	1705	1690	1676	1664	1653	1644	1635	1627	1620	1614	1608	1602	1597	1588
	21	q	1751	1708	1691	1676	1663	1651	1640	1631	1622	1614	1607	1601	1595	1589	1579
	20	q	1760	1713	1694	1678	1664	1651	1639	1629	1620	1611	1604	1596	1590	1584	1573
	19	q	1784	1730	1708	1689	1672	1657	1644	1632	1621	1611	1602	1594	1586	1579	1566
	18	q	1809	1748	1724	1702	1684	1667	1652	1638	1626	1615	1605	1596	1587	1579	1565
	16	q	1880	1803	1773	1746	1722	1701	1682	1666	1650	1636	1624	1612	1601	1591	1574
36/4	22	q	1905	1833	1804	1779	1757	1737	1719	1703	1689	1676	1664	1653	1643	1634	1617
	21	q	1937	1858	1827	1799	1775	1753	1734	1716	1700	1686	1673	1661	1650	1640	1621
	20	q	1972	1886	1852	1822	1795	1771	1750	1731	1714	1698	1684	1671	1659	1648	1628
	19	q	2048	1947	1907	1872	1841	1813	1788	1766	1746	1728	1711	1696	1682	1669	1645
	18	q	2114	2002	1957	1917	1882	1852	1824	1799	1776	1756	1737	1720	1704	1690	1664
	16	q	2283	2142	2085	2036	1992	1953	1919	1887	1859	1834	1810	1789	1769	1751	1718

See footnotes on page 51.

PLW2™ or W2 FORMLOK™

- 6¼ in. TOTAL SLAB DEPTH
- Light Weight Concrete
- 3 Hour Fire Rating

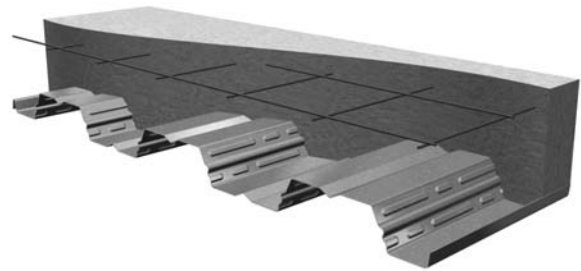

Maximum Unshored Clear Span (ft-in.)

Deck Gage	Number of Deck Spans		
	1	2	3
22	7'-2"	8'-4"	8'-5"
21	7'-10"	8'-11"	9'-3"
20	8'-6"	9'-6"	9'-10"
19	9'-4"	10'-7"	10'-11"
18	9'-8"	11'-4"	11'-9"
16	10'-5"	13'-0"	12'-5"

Shoring is required for spans greater than those shown above. See Footnote 1 on page 51 for required bearing.

Concrete Properties

Density (pcf)	Uniform Weight (psf)	Uniform Volume (yd ³ /100 ft ²)	Compressive Strength, f' _c (psi)
110	48.1	1.620	3000

Notes:

1. Volumes and weights do not include allowance for deflection.
2. Weights are for concrete only and do not include weight of steel deck.
3. Total slab depth is nominal depth from top of concrete to bottom of steel deck.

Allowable Superimposed Loads (psf)

Deck Gage	Number of Deck Spans	Span (ft-in.)														
		6'-0"	7'-0"	7'-6"	8'-0"	8'-6"	9'-0"	9'-6"	10'-0"	10'-6"	11'-0"	11'-6"	12'-0"	12'-6"	13'-0"	14'-0"
22	1	400	400	329	291	259	231	207	187	168	152	138	126	114	104	87
	2	400	400	375	337	259	231	207	187	168	152	138	126	114	104	87
	3	400	400	375	337	259	231	207	187	168	152	138	126	114	104	87
21	1	400	400	400	331	294	263	237	214	193	176	160	146	133	122	102
	2	400	400	400	376	340	263	237	214	193	176	160	146	133	122	102
	3	400	400	400	376	340	309	237	214	193	176	160	146	133	122	102
20	1	400	400	400	400	376	296	267	241	219	199	182	166	152	139	118
	2	400	400	400	400	376	342	313	241	219	199	182	166	152	139	118
	3	400	400	400	400	376	342	313	241	219	199	182	166	152	139	118
19	1	400	400	400	400	400	400	328	297	270	247	226	207	191	176	150
	2	400	400	400	400	400	400	374	343	317	247	226	207	191	176	150
	3	400	400	400	400	400	400	374	343	317	247	226	207	191	176	150
18	1	400	400	400	400	400	400	400	345	315	288	264	243	224	206	177
	2	400	400	400	400	400	400	400	392	361	334	264	243	224	206	177
	3	400	400	400	400	400	400	400	392	361	334	310	243	224	206	177
16	1	400	400	400	400	400	400	400	388	311	284	261	240	221	204	175
	2	400	400	400	400	400	400	400	388	358	331	308	286	268	251	175
	3	400	400	400	400	400	400	400	388	358	331	308	286	221	204	175

See footnotes on page 51.

Shoring required in shaded areas to right of heavy line.

Allowable Diaphragm Shear Strengths, q (plf) and Flexibility Factors, F (in./lb. x 10⁶)

Attachment Pattern	Deck Gage	q	Span (ft-in.)														
			6'-0"	7'-0"	7'-6"	8'-0"	8'-6"	9'-0"	9'-6"	10'-0"	10'-6"	11'-0"	11'-6"	12'-0"	12'-6"	13'-0"	14'-0"
36/3	22	q	2060	2021	2006	1992	1980	1969	1960	1951	1943	1936	1930	1924	1918	1913	1904
	21	q	2067	2024	2007	1992	1978	1967	1956	1947	1938	1930	1923	1917	1911	1905	1895
	20	q	2076	2029	2010	1994	1980	1967	1955	1945	1936	1927	1919	1912	1906	1900	1889
	19	q	2100	2046	2024	2005	1988	1973	1960	1948	1937	1927	1918	1909	1902	1895	1882
	18	q	2125	2064	2040	2018	1999	1983	1968	1954	1942	1931	1921	1912	1903	1895	1881
	16	q	2196	2119	2089	2062	2038	2017	1998	1981	1966	1952	1940	1928	1917	1907	1890
36/4	22	q	2221	2149	2120	2095	2073	2053	2035	2019	2005	1992	1980	1969	1959	1950	1933
	21	q	2253	2174	2143	2115	2091	2069	2050	2032	2016	2002	1989	1977	1966	1956	1937
	20	q	2288	2202	2168	2138	2111	2087	2066	2047	2030	2014	2000	1987	1975	1964	1944
	19	q	2364	2263	2223	2188	2157	2129	2104	2082	2062	2044	2027	2012	1998	1985	1961
	18	q	2430	2317	2272	2233	2198	2167	2140	2115	2092	2072	2053	2036	2020	2006	1980
	16	q	2599	2458	2401	2352	2308	2269	2235	2203	2175	2149	2126	2105	2085	2067	2034

See footnotes on page 51.

PLW2™ or W2 FORMLOK™

■ Without Concrete Fill



Allowable Uniform Loads (psf)

SPAN	DECK GAGE	CRITERIA	SPAN (ft-in.)																	
			6'-0"	6'-6"	7'-0"	7'-6"	8'-0"	8'-6"	9'-0"	9'-6"	10'-0"	10'-6"	11'-0"	11'-6"	12'-0"	12'-6"	13'-0"	13'-6"	14'-0"	
SINGLE	22	Stress	137	116	100	87	77	68	61	55	49	45	41	37	34	31	29	27	25	
		L/360	69	54	43	35	29	24	20	17	15	13	11	10	9	8	7	6	5	
		L/240	103	81	65	53	44	36	31	26	22	19	17	15	13	11	10	9	8	
			L/180	◆◆	108	87	71	58	48	41	35	30	26	22	20	17	15	14	12	11
	21	Stress	157	134	116	101	88	78	70	63	57	51	47	43	39	36	33	31	29	
		L/360	77	61	49	40	33	27	23	19	17	14	13	11	10	9	8	7	6	
		L/240	116	91	73	59	49	41	34	29	25	22	19	16	14	13	11	10	9	
			L/180	154	121	97	79	65	54	46	39	33	29	25	22	19	17	15	14	12
	20	Stress	179	153	132	115	101	89	80	72	65	59	53	49	45	41	38	35	33	
		L/360	86	67	54	44	36	30	25	22	18	16	14	12	11	9	8	8	7	
		L/240	128	101	81	66	54	45	38	32	28	24	21	18	16	14	13	11	10	
			L/180	171	135	108	88	72	60	51	43	37	32	28	24	21	19	17	15	13
19	Stress	225	192	165	144	127	112	100	90	81	73	67	61	56	52	48	44	41		
	L/360	102	80	64	52	43	36	30	26	22	19	17	14	13	11	10	9	8		
	L/240	153	120	96	78	65	54	45	39	33	29	25	22	19	17	15	13	12		
		L/180	204	160	128	104	86	72	60	51	44	38	33	29	25	23	20	18	16	
18	Stress	262	223	192	167	147	130	116	104	94	85	78	71	65	60	56	52	48		
	L/360	114	90	72	59	48	40	34	29	25	21	19	16	14	13	11	10	9		
	L/240	171	135	108	88	72	60	51	43	37	32	28	24	21	19	17	15	13		
		L/180	229	180	144	117	96	80	68	58	49	43	37	32	29	25	22	20	18	
16	Stress	300	295	254	222	195	172	154	138	125	113	103	94	87	80	74	68	64		
	L/360	143	113	90	73	60	50	42	36	31	27	23	20	18	16	14	13	11		
	L/240	215	169	135	110	91	76	64	54	46	40	35	31	27	24	21	19	17		
		L/180	287	225	180	147	121	101	85	72	62	53	47	41	36	32	28	25	23	

See footnotes on page 51.

PLW2™ or W2 FORMLOK™

■ Without Concrete Fill



Allowable Uniform Loads (psf)

SPAN	DECK GAGE	CRITERIA	SPAN (ft-in.)																	
			6'-0"	6'-6"	7'-0"	7'-6"	8'-0"	8'-6"	9'-0"	9'-6"	10'-0"	10'-6"	11'-0"	11'-6"	12'-0"	12'-6"	13'-0"	13'-6"	14'-0"	
DOUBLE	22	Stress	142	121	104	91	80	71	63	57	51	46	42	39	36	33	30	28	26	
		L/360	◆◆◆	◆◆◆	104	85	70	58	49	42	36	31	27	24	21	18	16	15	13	
		L/240	◆◆◆	◆◆◆	◆◆◆	◆◆◆	◆◆◆	◆◆◆	◆◆◆	◆◆◆	◆◆◆	◆◆◆	46	40	35	31	28	24	22	20
		L/180	◆◆◆	◆◆◆	◆◆◆	◆◆◆	◆◆◆	◆◆◆	◆◆◆	◆◆◆	◆◆◆	◆◆◆	◆◆◆	◆◆◆	◆◆◆	◆◆◆	◆◆◆	◆◆◆	◆◆◆	26
	21	Stress	163	139	120	105	92	81	73	65	59	53	49	44	41	38	35	32	30	
		L/360	◆◆◆	◆◆◆	117	95	78	65	55	47	40	35	30	26	23	21	18	16	15	
		L/240	◆◆◆	◆◆◆	◆◆◆	◆◆◆	◆◆◆	◆◆◆	◆◆◆	◆◆◆	◆◆◆	◆◆◆	52	45	40	35	31	27	24	22
		L/180	◆◆◆	◆◆◆	◆◆◆	◆◆◆	◆◆◆	◆◆◆	◆◆◆	◆◆◆	◆◆◆	◆◆◆	◆◆◆	◆◆◆	◆◆◆	◆◆◆	◆◆◆	◆◆◆	◆◆◆	29
	20	Stress	185	158	136	118	104	92	82	74	67	60	55	50	46	43	39	37	34	
		L/360	◆◆◆	◆◆◆	130	105	87	72	61	52	44	38	33	29	26	23	20	18	16	
		L/240	◆◆◆	◆◆◆	◆◆◆	◆◆◆	◆◆◆	◆◆◆	◆◆◆	◆◆◆	◆◆◆	◆◆◆	58	50	44	39	34	30	27	24
		L/180	◆◆◆	◆◆◆	◆◆◆	◆◆◆	◆◆◆	◆◆◆	◆◆◆	◆◆◆	◆◆◆	◆◆◆	◆◆◆	◆◆◆	◆◆◆	◆◆◆	◆◆◆	◆◆◆	◆◆◆	36
19	Stress	231	196	169	148	130	115	102	92	83	75	69	63	58	53	49	46	42		
	L/360	◆◆◆	193	155	126	104	86	73	62	53	46	40	35	31	27	24	22	19		
	L/240	◆◆◆	◆◆◆	◆◆◆	◆◆◆	◆◆◆	◆◆◆	◆◆◆	◆◆◆	◆◆◆	80	69	60	52	46	41	36	32	29	
	L/180	◆◆◆	◆◆◆	◆◆◆	◆◆◆	◆◆◆	◆◆◆	◆◆◆	◆◆◆	◆◆◆	◆◆◆	◆◆◆	◆◆◆	◆◆◆	◆◆◆	◆◆◆	48	43	39	
18	Stress	267	228	196	171	150	133	119	107	96	87	80	73	67	62	57	53	49		
	L/360	◆◆◆	216	173	141	116	97	82	69	59	51	45	39	34	30	27	24	22		
	L/240	◆◆◆	◆◆◆	◆◆◆	◆◆◆	◆◆◆	◆◆◆	◆◆◆	◆◆◆	104	89	77	67	59	52	46	41	36	32	
	L/180	◆◆◆	◆◆◆	◆◆◆	◆◆◆	◆◆◆	◆◆◆	◆◆◆	◆◆◆	◆◆◆	◆◆◆	◆◆◆	◆◆◆	◆◆◆	◆◆◆	61	54	48	43	
16	Stress	300	300	260	227	199	177	158	141	128	116	105	96	89	82	76	70	65		
	L/360	◆◆◆	271	217	177	146	121	102	87	75	64	56	49	43	38	34	30	27		
	L/240	◆◆◆	◆◆◆	◆◆◆	◆◆◆	◆◆◆	◆◆◆	◆◆◆	153	130	112	97	84	73	65	57	51	45	41	
	L/180	◆◆◆	◆◆◆	◆◆◆	◆◆◆	◆◆◆	◆◆◆	◆◆◆	◆◆◆	◆◆◆	◆◆◆	◆◆◆	◆◆◆	◆◆◆	86	76	68	61	54	

See footnotes on page 51.

PLW2™ or W2 FORMLOK™

■ Without Concrete Fill



Allowable Uniform Loads (psf)

SPAN	DECK GAGE	CRITERIA	SPAN (ft-in.)																
			6'-0"	6'-6"	7'-0"	7'-6"	8'-0"	8'-6"	9'-0"	9'-6"	10'-0"	10'-6"	11'-0"	11'-6"	12'-0"	12'-6"	13'-0"	13'-6"	14'-0"
TRIPLE	22	Stress	178	151	131	114	100	89	79	71	64	58	53	48	44	41	38	35	33
		L/360	130	102	82	66	55	46	38	33	28	24	21	18	16	14	13	11	10
		L/240	◆◆◆	◆◆◆	123	100	82	68	58	49	42	36	32	28	24	22	19	17	15
		L/180	◆◆◆	◆◆◆	◆◆◆	◆◆◆	◆◆◆	◆◆◆	77	65	56	48	42	37	32	29	26	23	20
	21	Stress	204	174	150	131	115	102	91	81	74	67	61	56	51	47	43	40	38
		L/360	145	114	92	74	61	51	43	37	31	27	24	21	18	16	14	13	11
		L/240	◆◆◆	172	137	112	92	77	65	55	47	41	35	31	27	24	21	19	17
		L/180	◆◆◆	◆◆◆	◆◆◆	◆◆◆	◆◆◆	◆◆◆	86	73	63	54	47	41	36	32	29	26	23
	20	Stress	231	197	170	148	130	115	103	92	83	76	69	63	58	53	49	46	42
		L/360	161	127	101	82	68	57	48	41	35	30	26	23	20	18	16	14	13
		L/240	◆◆◆	190	152	124	102	85	72	61	52	45	39	34	30	27	24	21	19
		L/180	◆◆◆	◆◆◆	◆◆◆	◆◆◆	◆◆◆	113	95	81	70	60	52	46	40	36	32	28	25
19	Stress	288	246	212	184	162	144	128	115	104	94	86	78	72	66	61	57	53	
	L/360	192	151	121	98	81	68	57	48	41	36	31	27	24	21	19	17	15	
	L/240	288	227	181	147	122	101	85	73	62	54	47	41	36	32	28	25	23	
	L/180	◆◆◆	◆◆◆	◆◆◆	◆◆◆	162	135	114	97	83	72	62	55	48	42	38	34	30	
18	Stress	300	285	245	214	188	166	148	133	120	109	99	91	84	77	71	66	61	
	L/360	215	169	136	110	91	76	64	54	47	40	35	31	27	24	21	19	17	
	L/240	◆◆◆	254	203	165	136	114	96	81	70	60	52	46	40	36	32	28	25	
	L/180	◆◆◆	◆◆◆	◆◆◆	◆◆◆	182	151	128	109	93	80	70	61	54	48	42	38	34	
16	Stress	300	300	300	284	249	221	197	177	160	145	132	121	111	102	94	88	81	
	L/360	270	212	170	138	114	95	80	68	58	50	44	38	34	30	27	24	21	
	L/240	◆◆◆	◆◆◆	255	207	171	142	120	102	87	76	66	58	51	45	40	36	32	
	L/180	◆◆◆	◆◆◆	◆◆◆	276	228	190	160	136	117	101	88	77	67	60	53	47	42	

See footnotes on page 51.

Type PLW2™ FORMLOK™

- Without Concrete Fill
- 36/4 Weld Pattern at Supports
- Sidelaps connected with PunchLok II Tool

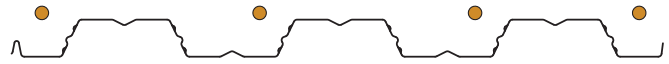

Allowable Diaphragm Shear Strengths, q (plf) and Flexibility Factors, F (in./lb. x 10⁶)

DECK GAGE	SIDELAP ATTACHMENT	SPAN (ft.-in.)									
		6'-0"	7'-0"	8'-0"	9'-0"	10'-0"	11'-0"	12'-0"	13'-0"	14'-0"	
22	VSC2 @ 24"	q	473	491	441	459	420	437	407	422	397
		F	11.4+25R	11.6+21R	13.1+18R	13.1+16R	14.4+14R	14.2+12R	15.3+11R	15+10R	16+9R
	VSC2 @ 12"	q	675	664	655	648	642	637	633	629	626
		F	8.2+26R	8.7+22R	9.1+19R	9.5+17R	9.8+15R	10+14R	10.2+13R	10.4+12R	10.6+11R
	VSC2 @ 8"	q	800	806	787	794	779	786	774	749	646
		F	6.6+27R	6.8+23R	7.3+20R	7.4+18R	7.7+16R	7.8+14R	8.1+13R	8.1+12R	8.3+11R
	VSC2 @ 4"	q	955	953	951	950	949	949	879	749	646
		F	4.5+27R	4.8+23R	5+20R	5.2+18R	5.4+16R	5.5+15R	5.6+14R	5.6+13R	5.7+12R
21	VSC2 @ 24"	q	564	585	525	547	501	522	485	504	473
		F	10.4+19R	10.5+16R	11.9+14R	11.7+12R	12.9+11R	12.7+10R	13.6+8R	13.4+8R	14.2+7R
	VSC2 @ 12"	q	805	791	780	772	765	759	754	750	745
		F	7.4+20R	7.9+17R	8.2+15R	8.5+13R	8.7+12R	8.9+11R	9.1+10R	9.2+9R	9.3+8R
	VSC2 @ 8"	q	952	960	937	946	928	936	922	864	745
		F	6+21R	6.2+18R	6.6+16R	6.6+14R	6.9+12R	6.9+11R	7.2+10R	7.1+10R	7.3+9R
	VSC2 @ 4"	q	1135	1133	1131	1130	1129	1128	1014	864	745
		F	4.2+21R	4.4+18R	4.6+16R	4.7+14R	4.8+13R	4.9+12R	5+11R	5.1+10R	5.1+9R
20	VSC2 @ 24"	q	658	682	613	638	585	608	565	587	552
		F	9.5+15R	9.5+13R	10.7+11R	10.5+10R	11.5+8R	11.2+8R	12.1+7R	11.8+6R	12.5+6R
	VSC2 @ 12"	q	940	923	911	901	893	886	880	875	849
		F	6.7+16R	7.1+14R	7.3+12R	7.5+11R	7.7+10R	7.9+9R	8+8R	8.1+7R	8.2+7R
	VSC2 @ 8"	q	1113	1122	1095	1105	1084	1094	1077	984	849
		F	5.4+17R	5.5+14R	5.9+13R	5.9+11R	6.2+10R	6.2+9R	6.3+8R	6.3+8R	6.5+7R
	VSC2 @ 4"	q	1329	1326	1324	1322	1321	1320	1155	984	849
		F	3.8+17R	4+15R	4.2+13R	4.3+11R	4.4+10R	4.4+9R	4.5+9R	4.5+8R	4.6+7R
19	VSC2 @ 24"	q	857	888	796	828	758	789	733	761	714
		F	7.7+10R	7.6+9R	8.5+7R	8.3+7R	9+6R	8.8+5R	9.4+5R	9.1+4R	9.7+4R
	VSC2 @ 12"	q	1226	1204	1187	1173	1162	1153	1145	1138	1069
		F	5.4+11R	5.6+10R	5.8+8R	5.9+7R	6.1+7R	6.1+6R	6.2+6R	6.3+5R	6.3+5R
	VSC2 @ 8"	q	1458	1470	1434	1446	1418	1430	1408	1240	1069
		F	4.4+12R	4.5+10R	4.7+9R	4.7+8R	4.9+7R	4.9+6R	5+6R	5+5R	5.1+5R
	VSC2 @ 4"	q	1753	1749	1747	1744	1742	1732	1455	1240	1069
		F	3.2+12R	3.3+10R	3.4+9R	3.5+8R	3.5+7R	3.6+6R	3.6+6R	3.7+5R	3.7+5R
18	VSC2 @ 24"	q	1034	1068	958	995	910	946	878	911	854
		F	6.5+8R	6.4+7R	7.1+6R	6.9+5R	7.4+4R	7.2+4R	7.7+4R	7.5+3R	7.9+3R
	VSC2 @ 12"	q	1482	1453	1431	1414	1399	1387	1377	1369	1263
		F	4.6+9R	4.7+7R	4.8+6R	4.9+6R	5+5R	5.1+5R	5.1+4R	5.2+4R	5.2+4R
	VSC2 @ 8"	q	1769	1783	1737	1753	1717	1732	1703	1465	1263
		F	3.7+9R	3.8+7R	3.9+7R	3.9+6R	4.1+5R	4.1+5R	4.2+4R	4.1+4R	4.2+4R
	VSC2 @ 4"	q	2145	2140	2136	2133	2130	2047	1720	1465	1263
		F	2.8+9R	2.9+8R	2.9+7R	3+6R	3+5R	3.1+5R	3.1+4R	3.1+4R	3.2+4R
16	VSC2 @ 24"	q	1367	1418	1273	1325	1215	1264	1175	1220	1146
		F	5.4+4R	5.3+4R	5.8+3R	5.6+3R	6.1+2R	5.9+2R	6.3+2R	6+2R	6.4+2R
	VSC2 @ 12"	q	1953	1919	1893	1872	1855	1841	1829	1819	1777
		F	3.8+5R	3.9+4R	4+4R	4+3R	4.1+3R	4.1+3R	4.2+2R	4.2+2R	4.2+2R
	VSC2 @ 8"	q	2313	2332	2277	2297	2254	2273	2238	2060	1777
		F	3.1+5R	3.1+4R	3.2+4R	3.2+3R	3.3+3R	3.3+3R	3.4+2R	3.3+2R	3.4+2R
	VSC2 @ 4"	q	2762	2757	2753	2750	2747	2745	2418	2060	1777
		F	2.4+5R	2.4+4R	2.4+4R	2.5+3R	2.5+3R	2.5+3R	2.5+3R	2.5+2R	2.6+2R

See footnotes on page 51.

Type W2 FORMLOK™

- Without Concrete Fill
- 3/4" Weld Pattern at Supports
- Sidelaps connected with Button Punch or 1½" Top Seam Weld

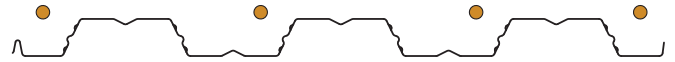

Allowable Diaphragm Shear Strengths, q (plf) and Flexibility Factors, F (in./lb. x 10⁶)

DECK GAGE	SIDELAP ATTACHMENT	SPAN (ft.-in.)									
		6'-0"	7'-0"	8'-0"	9'-0"	10'-0"	11'-0"	12'-0"	13'-0"	14'-0"	
22	BP @ 24"	q	188	171	150	141	127	122	112	109	101
		F	18.2+20R	20.4+16R	23.2+12R	24.9+9R	27.6+6R	29+4R	31.5+2R	32.8+1R	35.1-1R
	BP @ 12"	q	224	202	186	173	163	155	148	142	137
		F	16.3+22R	18.3+17R	20.1+14R	21.7+11R	23.2+9R	24.6+7R	25.9+6R	27.1+4R	28.2+3R
	TSW @ 24"	q	530	553	501	523	482	503	470	489	461
		F	5.4+27R	5.3+23R	6+20R	5.9+18R	6.4+16R	6.2+15R	6.6+13R	6.4+12R	6.8+11R
TSW @ 12"	q	743	734	726	721	716	712	709	706	646	
	F	3.8+27R	4.1+23R	4.3+20R	4.4+18R	4.6+16R	4.7+15R	4.7+14R	4.8+13R	4.9+12R	
21	BP @ 24"	q	226	204	179	168	152	146	134	130	121
		F	17.5+15R	19.5+11R	22.1+8R	23.8+6R	26.3+3R	27.7+2R	30+0R	31.2-1R	33.5-3R
	BP @ 12"	q	270	241	222	207	195	185	177	170	164
		F	15.6+16R	17.5+12R	19.2+10R	20.7+8R	22.1+6R	23.4+4R	24.7+3R	25.8+2R	26.9+1R
	TSW @ 24"	q	615	641	579	605	557	580	541	563	530
		F	5.3+21R	5.2+18R	5.8+16R	5.6+14R	6.1+13R	5.9+12R	6.3+11R	6.1+10R	6.4+9R
TSW @ 12"	q	866	854	845	838	832	828	823	820	745	
	F	3.7+21R	4+18R	4.1+16R	4.3+14R	4.4+13R	4.4+12R	4.5+11R	4.6+10R	4.6+9R	
20	BP @ 24"	q	267	240	210	198	178	172	157	153	142
		F	16.8+11R	18.7+8R	21.2+5R	22.8+3R	25.2+1R	26.5+0R	28.7-2R	29.8-3R	32-4R
	BP @ 12"	q	319	284	262	244	230	219	209	201	194
		F	15+12R	16.8+9R	18.4+7R	19.8+5R	21.2+4R	22.4+2R	23.6+1R	24.7+0R	25.7+0R
	TSW @ 24"	q	704	733	661	690	635	661	616	641	603
		F	5.1+17R	5+15R	5.5+13R	5.4+11R	5.8+10R	5.6+9R	6+8R	5.8+8R	6.1+7R
TSW @ 12"	q	996	981	970	962	955	949	944	940	849	
	F	3.7+17R	3.8+15R	4+13R	4.1+12R	4.2+10R	4.2+9R	4.3+9R	4.3+8R	4.4+7R	
19	BP @ 24"	q	360	323	281	265	239	230	211	205	191
		F	15.7+6R	17.4+4R	19.6+1R	21.1+0R	23.2-2R	24.5-3R	26.5-4R	27.6-5R	29.5-6R
	BP @ 12"	q	430	383	351	328	309	294	281	270	261
		F	14+7R	15.6+5R	17+3R	18.3+2R	19.6+1R	20.7+0R	21.8-1R	22.8-2R	23.7-2R
	TSW @ 24"	q	897	931	838	873	801	834	776	807	758
		F	4.8+11R	4.7+10R	5.1+9R	5+8R	5.3+7R	5.2+6R	5.5+6R	5.3+5R	5.6+5R
TSW @ 12"	q	1276	1256	1240	1227	1217	1208	1201	1195	1069	
	F	3.5+12R	3.6+10R	3.7+9R	3.7+8R	3.8+7R	3.9+6R	3.9+6R	3.9+5R	4+5R	
18	BP @ 24"	q	447	402	347	328	295	285	261	254	236
		F	14.8+3R	16.4+1R	18.5+0R	19.9-1R	21.9-3R	23.1-4R	25-5R	26-5R	27.8-6R
	BP @ 12"	q	535	478	435	407	384	365	349	336	325
		F	13.2+4R	14.7+3R	16.1+1R	17.3+0R	18.4-1R	19.5-1R	20.5-2R	21.4-3R	22.3-3R
	TSW @ 24"	q	1071	1110	997	1037	950	988	919	954	896
		F	4.5+9R	4.4+7R	4.8+6R	4.6+6R	5+5R	4.8+5R	5.1+4R	4.9+4R	5.2+4R
TSW @ 12"	q	1530	1503	1482	1466	1452	1441	1432	1424	1263	
	F	3.3+9R	3.4+8R	3.4+7R	3.5+6R	3.6+5R	3.6+5R	3.6+4R	3.7+4R	3.7+4R	
16	BP @ 24"	q	602	548	473	447	402	391	359	352	327
		F	13.2+0R	14.6-1R	16.5-3R	17.7-3R	19.5-4R	20.5-5R	22.2-6R	23.1-6R	24.7-7R
	BP @ 12"	q	741	667	612	571	542	518	498	481	466
		F	11.8+1R	13.1+0R	14.2-1R	15.3-2R	16.4-2R	17.3-3R	18.2-3R	19-4R	19.8-4R
	TSW @ 24"	q	1407	1462	1315	1370	1258	1310	1219	1266	1190
		F	4+5R	3.9+4R	4.2+3R	4+3R	4.3+3R	4.2+3R	4.4+2R	4.3+2R	4.5+2R
TSW @ 12"	q	2002	1970	1945	1926	1910	1896	1885	1876	1777	
	F	2.9+5R	2.9+4R	3+4R	3+3R	3.1+3R	3.1+3R	3.1+2R	3.1+2R	3.1+2R	

See footnotes on page 51.

Notes:

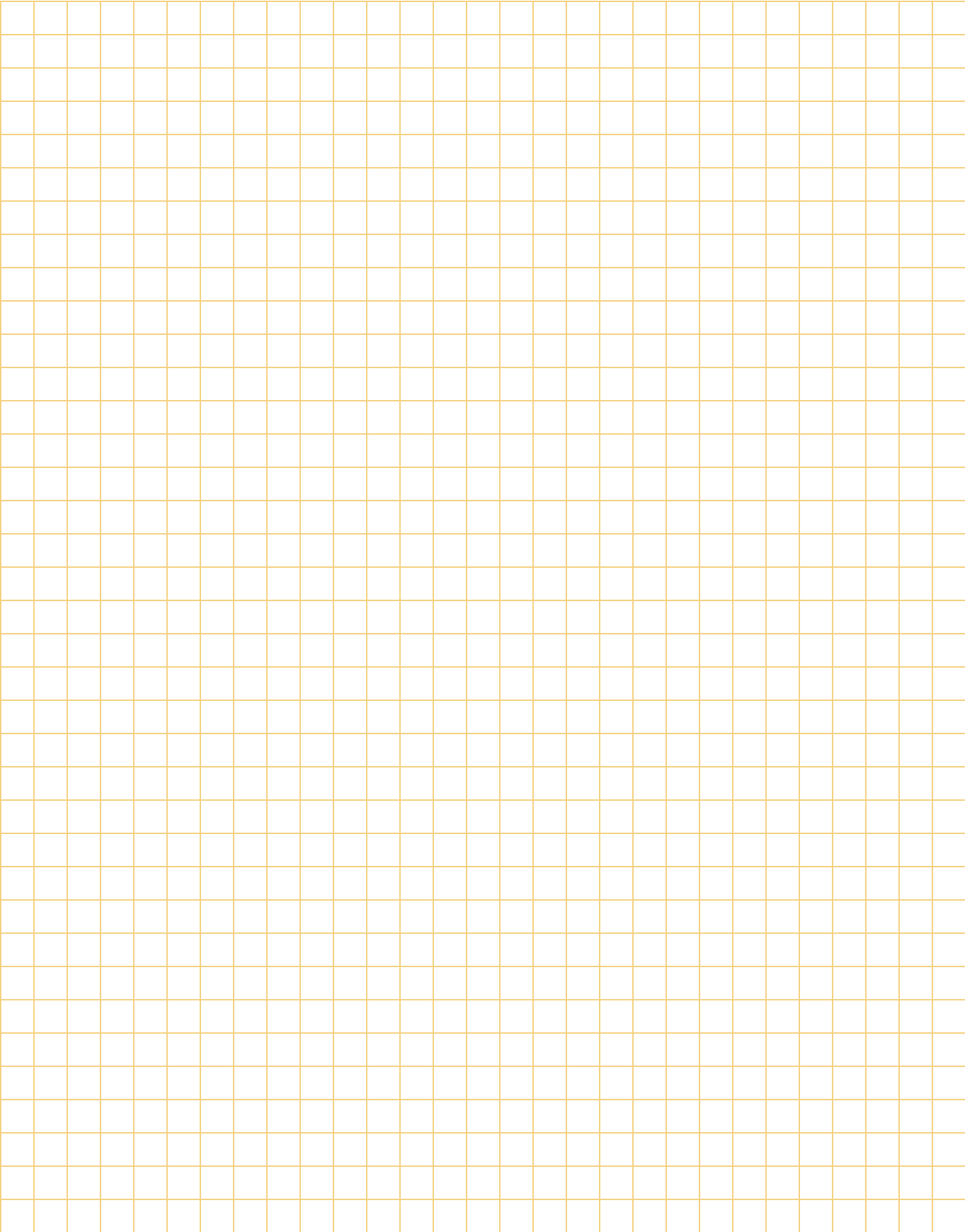

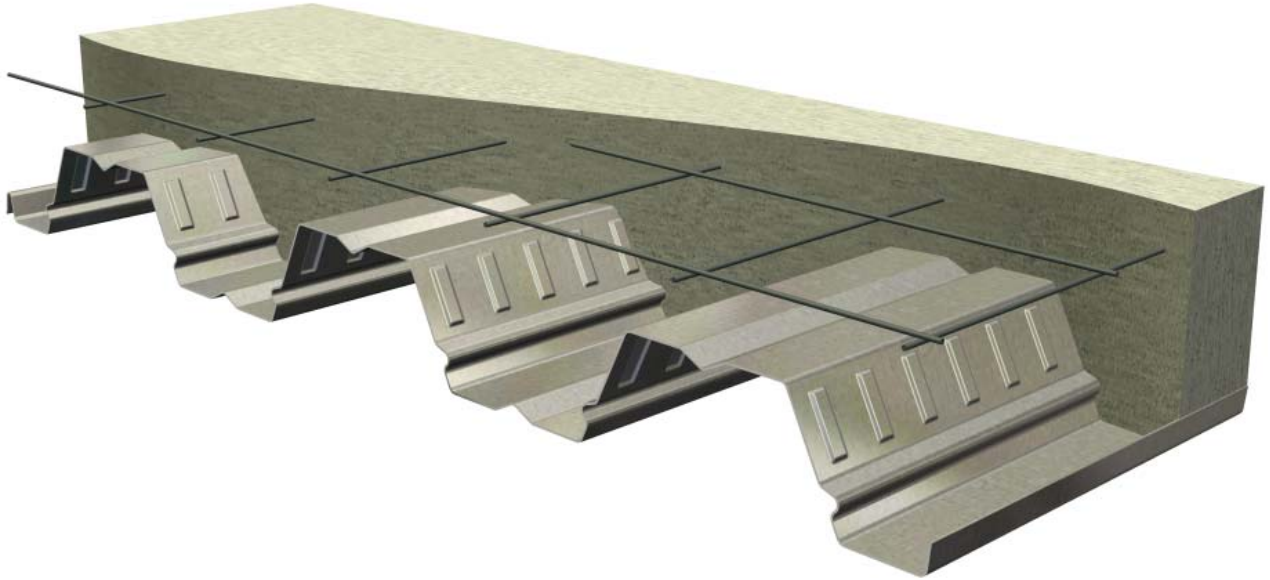

PLW3™ FORMLOK™ and W3 FORMLOK™

PLW3™ AND W3 FORMLOK™ CONTENTS

Section Properties	68
PLW3™ and W3 FORMLOK™ Tables	70-78
5 in. Total Slab Depth Normal Weight Concrete	70
5½ in. Total Slab Depth Normal Weight Concrete	71
6 in. Total Slab Depth Normal Weight Concrete	72
6½ in. Total Slab Depth Normal Weight Concrete	73
7½ in. Total Slab Depth Normal Weight Concrete	74
4 in. Total Slab Depth Light Weight Concrete	75
4½ in. Total Slab Depth Light Weight Concrete	76
5¼ in. Total Slab Depth Light Weight Concrete	77
6¼ in. Total Slab Depth Light Weight Concrete	78
PLW3™ and W3 FORMLOK™ without Concrete Fill	79-83
Allowable Uniform Load Tables	79-81
PLW3 FORMLOK Diaphragm Tables	82
W3 FORMLOK Diaphragm Tables	83

PLW3™ or W3 FORMLOK™

- 3 in. Deep FORMLOK Deck
- Phosphatized/Painted or Galvanized
- PLW3 FORMLOK used with PunchLok II System
- W3 FORMLOK used with TSWs or BPs
- W3 FORMLOK-SS used with Screws

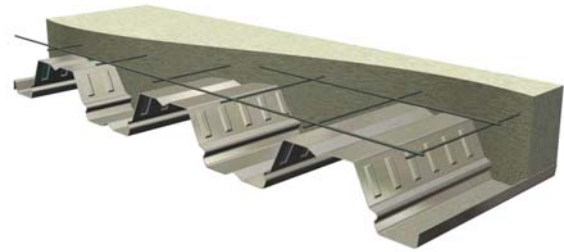

Dimensions

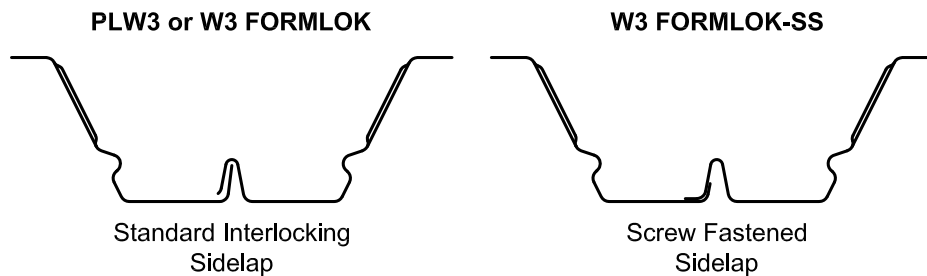
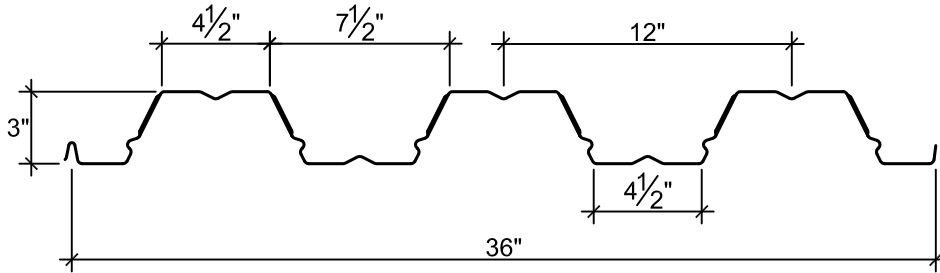

Deck Weight and Section Properties

Gage	Weight		I_d for Deflection		Moment		Allowable Reactions per ft of Width (lb) due to Web Crippling									
	Galv (psf)	Painted (psf)	Single Span (in. ⁴ /ft)	Multi Span (in. ⁴ /ft)	+ S_{eff} (in. ³ /ft)	- S_{eff} (in. ³ /ft)	One Flange Loading					Two Flange Loading				
							End Bearing Length		Interior Bearing Length			End Bearing Length		Interior Bearing Length		
							2"	3"	4"	4"	8"	2"	3"	4"	4"	8"
22	1.9	1.8	0.736	0.736	0.393	0.410	383	441	490	778	908	354	397	432	901	1063
21	2.1	2.0	0.824	0.824	0.453	0.470	461	530	588	934	1126	443	495	539	1093	1334
20	2.3	2.2	0.907	0.907	0.510	0.528	540	619	686	1091	1352	535	597	649	1287	1618
19	2.7	2.6	1.067	1.067	0.636	0.652	724	828	914	1456	1832	757	840	911	1741	2226
18	2.9	2.8	1.213	1.213	0.752	0.768	922	1049	1157	1845	2310	1002	1109	1199	2229	2836
16	3.5	3.4	1.516	1.516	0.968	0.966	1395	1581	1737	2780	3449	1614	1777	1913	3406	4298

- Notes:**
1. Section properties are based on $F_y = 50,000$ psi.
 2. I_d is for deflection due to uniform loads.
 3. S_{eff} (+ or -) is the effective section modulus.
 4. Allowable (ASD) reactions are based on web crippling, per AISI S100 Section C3.4, where $\Omega_w = 1.70$ for end bearing and 1.75 for interior bearing. Nominal reactions may be determined by multiplying the table values by Ω_w . LRFD reactions may be determined by multiplying nominal reactions by $\phi_w = 0.9$ for end reactions and 0.85 for interior reactions.

Attachment Patterns to Supports

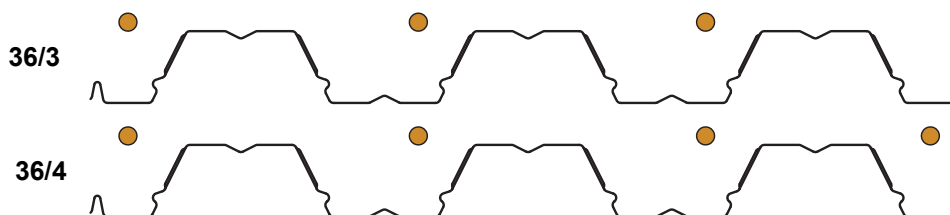

Note: ● indicates location of arc spot weld, power actuated fastener, or screw as indicated in the load tables.

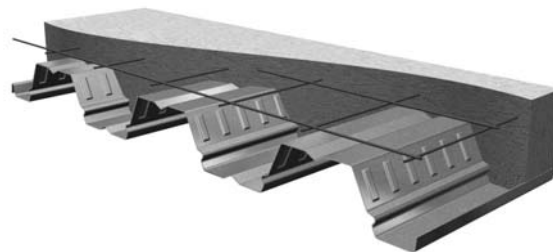

Footnotes for Maximum Unshored Clear Span, Allowable Superimposed Loads, and Allowable Diaphragm Shear Strength Tables

- Shoring calculations are based on the following:
 - Deck supporting dead load of concrete plus 20 psf uniform construction load or 150 pound concentrated construction live load for flexure. 4 psf is added for normal weight concrete and 3 psf is added for light weight concrete to account for ponding due to deck deflection between support members.
 - Dead load deflection limited to L/180 of span length, not to exceed 3/4".
 - Minimum end bearing of 2" for 16 to 21 gage. Minimum end bearing varies from 2" to 2.5" for 22 gage, depending on slab thickness. Minimum interior bearing for all gages varies from 2" to 6.5", depending on deck gage and slab thickness. Required bearing should be determined based on allowable reactions shown on page 68.
- Concrete fill to have minimum 28-day compressive strength $f'_c = 3,000$ psi.
- Total slab depth is nominal depth from top of concrete to bottom of steel deck.
- Shoring is required at midspan for allowable superimposed loads in the shaded area to the right of the heavy line.
- Nominal diaphragm shear strengths may be determined by multiplying the tabulated strengths by $\Omega = 3.0$. LRFD diaphragm shear strength may be determined by multiplying nominal diaphragm shear strength by $\phi = 0.55$.
- PLW3-36 and W3-36 FORMLOK decks with structural concrete have a Flexibility Factor of $F < 1$.
- To obtain allowable diaphragm shear strengths using mechanical fasteners, multiply the tabulated strengths by the appropriate adjustment factor, A_q listed in the following table.

Attachment Pattern	Adjustment Factor	Total Slab Depth (in.)								
		Normal Weight Concrete					Light Weight Concrete			
		5	5½	6	6½	7½	5	5½	6¼	7¼
36/3	A_{q3}	0.78	0.68	0.60	0.54	0.45	0.67	0.74	0.75	0.63
36/4	A_{q4}	0.73	0.79	0.77	0.69	0.58	0.63	0.68	0.75	0.80

Notes:

- Mechanical fastener attachment patterns are to match the listed attachment patterns for welds.
- Applicable mechanical fasteners are limited to the following: Hilti Fasteners, Pneutek Fasteners and SDI Recognized #12 or #14 Screws produced by Buildex, Elco, Hilti or Simpson Strong-Tie. Comply with minimum and maximum substrate thickness requirements for applicable mechanical fasteners. Note that these adjustment factors are based on the most conservative value for all listed connectors.
- Nominal diaphragm shear strengths for mechanically fastened FORMLOK slabs may be determined by multiplying the adjusted table values by $\Omega = 3.25$. LRFD diaphragm shear values for mechanically fastened FORMLOK slabs may be determined by multiplying the adjusted nominal values by $\phi = 0.50$.
- Consult fastener manufacturer for applicable fire-resistance assembly ratings where mechanical fasteners are required.

Footnotes for Allowable Uniform Load Tables for Deck without Concrete Fill

- Stress = Allowable uniform load based on maximum allowable flexural stress in deck.
- L/360, L/240 or L/180 = Uniform load which produces selected deflection in deck.
- The symbol ♦♦♦ indicates allowable uniform load based on deflection exceeds allowable uniform load based on stress.
- Nominal uniform loads governed by stress may be determined by multiplying the allowable loads in the table by $\Omega_b = 1.67$. LRFD loads may be determined by multiplying nominal loads by $\phi_b = 0.95$.

Footnotes for Diaphragm Shear Strength and Flexibility Factor Tables for Deck without Concrete Fill

- VSC2 = Verco Sidelap Connection 2; BP = Button Punch; TSW = Top Seam Weld. Sidelap connections are not required at support locations.
- The end dimension to the first and last sidelap connection within each span is to be no more than one-half of specified spacing.
- R is the ratio of vertical span (L_V) of the deck to the length (L_S) of the deck sheet: $R = L_V / L_S$.
- Interpolation of diaphragm shear strength between adjacent spans or sidelap spacings is permissible. For interpolation of the diaphragm flexibility factor between adjacent spans, use the flexibility factor for the closest adjacent span length.
- Interpolation of diaphragm shear strengths for sidelap fasteners placed at spacings other than those in the table should be based on the number of fasteners in each span.
- The allowable diaphragm shear strengths in the tables utilize a factor of safety, $\Omega = 3.0$ (limited by connections), with the exception of the shaded table strengths, which utilize a factor of safety of $\Omega = 2.0$ (limited by panel buckling).

PLW3™ or W3 FORMLOK™

- 5 in. TOTAL SLAB DEPTH
- Normal Weight Concrete

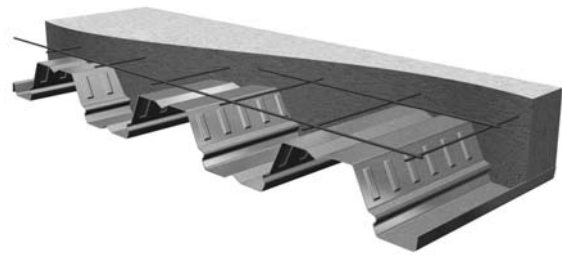

Maximum Unshored Clear Span (ft-in.)

Deck Gage	Number of Deck Spans		
	1	2	3
22	10'-0"	10'-7"	11'-4"
21	10'-11"	11'-8"	12'-1"
20	11'-7"	12'-4"	12'-10"
19	12'-1"	13'-9"	14'-2"
18	12'-5"	14'-10"	14'-7"
16	13'-1"	16'-4"	15'-4"

Concrete Properties

Density (pcf)	Uniform Weight (psf)	Uniform Volume (yd ³ /100 ft ²)	Compressive Strength, f' _c (psi)
145	42.3	1.080	3000

Notes:

1. Volumes and weights do not include allowance for deflection.
2. Weights are for concrete only and do not include weight of steel deck.
3. Total slab depth is nominal depth from top of concrete to bottom of steel deck.

Shoring is required for spans greater than those shown above. See Footnote 1 on page 69 for required bearing.

Allowable Superimposed Loads (psf)

Deck Gage	Number of Deck Spans	Span (ft-in.)														
		8'-0"	8'-6"	9'-0"	9'-6"	10'-0"	10'-6"	11'-0"	11'-6"	12'-0"	12'-6"	13'-0"	13'-6"	14'-0"	15'-0"	16'-0"
22	1	254	229	208	190	175	120	108	97	88	79	72	65	58	48	39
	2	254	229	208	190	175	161	108	97	88	79	72	65	58	48	39
	3	254	229	208	190	175	161	108	97	88	79	72	65	58	48	39
21	1	274	248	225	206	189	174	120	108	98	89	81	73	66	55	45
	2	274	248	225	206	189	174	161	150	98	89	81	73	66	55	45
	3	274	248	225	206	189	174	161	150	140	89	81	73	66	55	45
20	1	294	265	241	220	202	187	173	160	108	98	89	81	74	61	51
	2	294	265	241	220	202	187	173	160	149	98	89	81	74	61	51
	3	294	265	241	220	202	187	173	160	149	140	89	81	74	61	51
19	1	333	301	274	250	230	212	191	172	155	116	106	97	89	75	63
	2	333	301	274	250	230	212	191	172	155	140	126	115	89	75	63
	3	333	301	274	250	230	212	191	172	155	140	126	115	104	75	63
18	1	370	334	304	278	255	232	208	187	169	134	122	112	103	88	74
	2	370	334	304	278	255	232	208	187	169	153	139	126	115	88	74
	3	370	334	304	278	255	232	208	187	169	153	139	126	115	88	74
16	1	400	400	365	333	299	268	241	217	197	178	162	143	132	113	95
	2	400	400	365	333	299	268	241	217	197	178	162	148	135	113	95
	3	400	400	365	333	299	268	241	217	197	178	162	148	135	113	95

See footnotes on page 69.

Shoring required in shaded areas to right of heavy line.

Allowable Diaphragm Shear Strengths, q (plf)

Attachment Pattern	Deck Gage	Span (ft-in.)															
		8'-0"	8'-6"	9'-0"	9'-6"	10'-0"	10'-6"	11'-0"	11'-6"	12'-0"	12'-6"	13'-0"	13'-6"	14'-0"	15'-0"	16'-0"	
36/3	22	q	1606	1594	1583	1573	1565	1557	1550	1544	1538	1532	1527	1523	1518	1511	1504
	21	q	1605	1592	1580	1570	1560	1552	1544	1537	1530	1524	1519	1514	1509	1500	1493
	20	q	1608	1593	1580	1569	1559	1549	1541	1533	1526	1520	1513	1508	1503	1493	1485
	19	q	1618	1602	1587	1573	1561	1550	1540	1531	1523	1515	1508	1502	1496	1485	1475
	18	q	1634	1615	1598	1583	1569	1557	1546	1535	1526	1517	1509	1502	1495	1482	1472
	16	q	1679	1655	1633	1614	1597	1582	1568	1555	1543	1532	1522	1513	1504	1489	1475
36/4	22	q	1708	1686	1666	1648	1633	1618	1605	1593	1583	1572	1563	1555	1547	1532	1520
	21	q	1729	1704	1683	1663	1646	1630	1616	1602	1590	1579	1569	1560	1551	1535	1521
	20	q	1750	1724	1700	1679	1660	1643	1627	1613	1600	1588	1577	1567	1557	1540	1525
	19	q	1801	1770	1742	1718	1696	1675	1657	1640	1625	1611	1598	1586	1575	1555	1537
	18	q	1854	1819	1787	1759	1734	1711	1690	1671	1654	1638	1623	1609	1597	1574	1554
	16	q	1973	1929	1890	1855	1823	1795	1769	1745	1723	1703	1684	1667	1651	1623	1598

See footnotes on page 69.

PLW3™ or W3 FORMLOK™

- 5½ in. TOTAL SLAB DEPTH
- Normal Weight Concrete

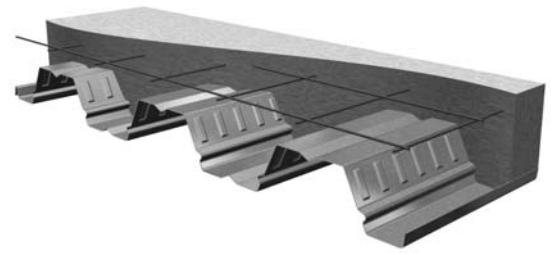

Maximum Unshored Clear Span (ft-in.)

Deck Gage	Number of Deck Spans		
	1	2	3
22	9'-7"	9'-9"	10'-10"
21	10'-5"	11'-2"	11'-7"
20	11'-2"	11'-10"	12'-3"
19	11'-9"	13'-2"	13'-7"
18	12'-1"	14'-3"	14'-2"
16	12'-9"	15'-11"	14'-11"

Shoring is required for spans greater than those shown above. See Footnote 1 on page 69 for required bearing.

Concrete Properties

Density (pcf)	Uniform Weight (psf)	Uniform Volume (yd ³ /100 ft ²)	Compressive Strength, f' _c (psi)
145	48.3	1.235	3000

Notes:

1. Volumes and weights do not include allowance for deflection.
2. Weights are for concrete only and do not include weight of steel deck.
3. Total slab depth is nominal depth from top of concrete to bottom of steel deck.

Allowable Superimposed Loads (psf)

Deck Gage	Number of Deck Spans	Span (ft-in.)														
		8'-0"	8'-6"	9'-0"	9'-6"	10'-0"	10'-6"	11'-0"	11'-6"	12'-0"	12'-6"	13'-0"	13'-6"	14'-0"	15'-0"	16'-0"
22	1	278	251	228	209	145	130	117	105	95	85	77	70	63	51	41
	2	278	251	228	209	145	130	117	105	95	85	77	70	63	51	41
	3	278	251	228	209	145	130	117	105	95	85	77	70	63	51	41
21	1	300	271	247	225	207	144	130	117	106	96	87	79	71	59	48
	2	300	271	247	225	207	191	177	117	106	96	87	79	71	59	48
	3	300	271	247	225	207	191	177	164	106	96	87	79	71	59	48
20	1	321	290	264	241	221	204	189	128	116	106	96	87	79	66	54
	2	321	290	264	241	221	204	189	175	116	106	96	87	79	66	54
	3	321	290	264	241	221	204	189	175	163	106	96	87	79	66	54
19	1	363	328	298	273	250	231	214	198	138	125	115	105	96	80	67
	2	363	328	298	273	250	231	214	198	185	173	162	105	96	80	67
	3	363	328	298	273	250	231	214	198	185	173	162	152	96	80	67
18	1	400	364	331	302	277	256	237	220	205	144	132	121	111	94	79
	2	400	364	331	302	277	256	237	220	205	191	179	168	158	94	79
	3	400	364	331	302	277	256	237	220	205	191	179	168	158	94	79
16	1	400	400	395	361	332	306	283	263	245	223	166	153	141	121	104
	2	400	400	395	361	332	306	283	263	245	223	203	185	169	142	104
	3	400	400	395	361	332	306	283	263	245	223	203	185	169	121	104

See footnotes on page 69.

Shoring required in shaded areas to right of heavy line.

Allowable Diaphragm Shear Strengths, q (plf)

Attachment Pattern	Deck Gage	Span (ft-in.)															
		8'-0"	8'-6"	9'-0"	9'-6"	10'-0"	10'-6"	11'-0"	11'-6"	12'-0"	12'-6"	13'-0"	13'-6"	14'-0"	15'-0"	16'-0"	
36/3	22	q	1845	1833	1822	1813	1804	1796	1789	1783	1777	1771	1766	1762	1757	1750	1743
	21	q	1844	1831	1819	1809	1799	1791	1783	1776	1769	1763	1758	1753	1748	1739	1732
	20	q	1847	1832	1819	1808	1798	1788	1780	1772	1765	1759	1753	1747	1742	1733	1724
	19	q	1857	1841	1826	1812	1800	1789	1779	1770	1762	1754	1747	1741	1735	1724	1714
	18	q	1873	1854	1837	1822	1808	1796	1785	1774	1765	1756	1748	1741	1734	1721	1711
	16	q	1918	1894	1873	1853	1836	1821	1807	1794	1782	1771	1761	1752	1743	1728	1714
36/4	22	q	1947	1925	1905	1888	1872	1857	1844	1832	1822	1812	1802	1794	1786	1772	1759
	21	q	1968	1943	1922	1902	1885	1869	1855	1842	1829	1818	1808	1799	1790	1774	1760
	20	q	1989	1963	1939	1918	1899	1882	1866	1852	1839	1827	1816	1806	1796	1779	1764
	19	q	2040	2009	1982	1957	1935	1915	1896	1880	1864	1850	1837	1825	1814	1794	1776
	18	q	2093	2058	2027	1998	1973	1950	1929	1910	1893	1877	1862	1849	1836	1813	1793
	16	q	2213	2168	2129	2094	2062	2034	2008	1984	1962	1942	1924	1906	1891	1862	1837

See footnotes on page 69.

PLW3™ or W3 FORMLOK™

- 6 in. TOTAL SLAB DEPTH
- Normal Weight Concrete

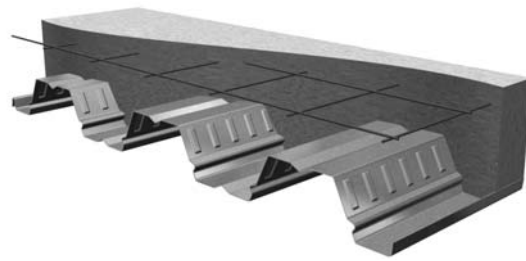

Maximum Unshored Clear Span (ft-in.)

Deck Gage	Number of Deck Spans		
	1	2	3
22	9'-2"	9'-0"	10'-3"
21	10'-0"	10'-9"	11'-2"
20	10'-8"	11'-5"	11'-10"
19	11'-5"	12'-8"	13'-1"
18	11'-9"	13'-8"	13'-9"
16	12'-5"	15'-4"	14'-6"

Shoring is required for spans greater than those shown above. See Footnote 1 on page 69 for required bearing.

Concrete Properties

Density (pcf)	Uniform Weight (psf)	Uniform Volume (yd ³ /100 ft ²)	Compressive Strength, f' _c (psi)
145	54.4	1.389	3000

Notes:

1. Volumes and weights do not include allowance for deflection.
2. Weights are for concrete only and do not include weight of steel deck.
3. Total slab depth is nominal depth from top of concrete to bottom of steel deck.

Allowable Superimposed Loads (psf)

Deck Gage	Number of Deck Spans	Span (ft-in.)															
		8'-0"	8'-6"	9'-0"	9'-6"	10'-0"	10'-6"	11'-0"	11'-6"	12'-0"	12'-6"	13'-0"	13'-6"	14'-0"	15'-0"	16'-0"	
22	1	304	274	250	176	158	141	127	114	103	93	83	75	68	55	44	
	2	304	274	250	176	158	141	127	114	103	93	83	75	68	55	44	
	3	304	274	250	176	158	141	127	114	103	93	83	75	68	55	44	
21	1	328	296	269	246	226	157	141	127	115	104	94	85	77	63	51	
	2	328	296	269	246	226	208	141	127	115	104	94	85	77	63	51	
	3	328	296	269	246	226	208	193	127	115	104	94	85	77	63	51	
20	1	350	317	288	263	241	223	154	139	126	114	104	94	86	71	58	
	2	350	317	288	263	241	223	206	139	126	114	104	94	86	71	58	
	3	350	317	288	263	241	223	206	191	126	114	104	94	86	71	58	
19	1	396	358	325	297	273	252	233	164	149	136	124	113	104	87	72	
	2	396	358	325	297	273	252	233	216	201	188	124	113	104	87	72	
	3	396	358	325	297	273	252	233	216	201	188	176	113	104	87	72	
18	1	400	396	360	329	302	278	258	239	170	156	142	131	120	101	85	
	2	400	396	360	329	302	278	258	239	223	208	195	183	120	101	85	
	3	400	396	360	329	302	278	258	239	223	208	195	183	120	101	85	
16	1	400	400	400	392	360	332	307	285	266	195	179	165	152	130	111	
	2	400	400	400	392	360	332	307	285	266	248	233	218	206	176	111	
	3	400	400	400	392	360	332	307	285	266	248	233	218	206	130	111	

See footnotes on page 69.

Shoring required in shaded areas to right of heavy line.

Allowable Diaphragm Shear Strengths, q (plf)

Attachment Pattern	Deck Gage	Span (ft-in.)															
		8'-0"	8'-6"	9'-0"	9'-6"	10'-0"	10'-6"	11'-0"	11'-6"	12'-0"	12'-6"	13'-0"	13'-6"	14'-0"	15'-0"	16'-0"	
36/3	22	q	2084	2072	2061	2052	2043	2035	2028	2022	2016	2010	2005	2001	1997	1989	1982
	21	q	2083	2070	2058	2048	2038	2030	2022	2015	2009	2003	1997	1992	1987	1979	1971
	20	q	2086	2071	2059	2047	2037	2027	2019	2011	2004	1998	1992	1986	1981	1972	1963
	19	q	2097	2080	2065	2051	2039	2028	2019	2009	2001	1994	1987	1980	1974	1963	1954
	18	q	2112	2093	2076	2061	2047	2035	2024	2013	2004	1995	1987	1980	1973	1961	1950
	16	q	2157	2133	2112	2093	2075	2060	2046	2033	2021	2010	2000	1991	1982	1967	1953
36/4	22	q	2186	2164	2144	2127	2111	2096	2083	2072	2061	2051	2041	2033	2025	2011	1998
	21	q	2207	2182	2161	2141	2124	2108	2094	2081	2069	2058	2047	2038	2029	2013	1999
	20	q	2229	2202	2178	2157	2138	2121	2105	2091	2078	2066	2055	2045	2035	2018	2003
	19	q	2279	2248	2221	2196	2174	2154	2135	2119	2103	2089	2076	2064	2053	2033	2015
	18	q	2332	2297	2266	2237	2212	2189	2169	2150	2132	2116	2101	2088	2075	2052	2032
	16	q	2452	2407	2368	2333	2301	2273	2247	2223	2201	2181	2163	2145	2130	2101	2076

See footnotes on page 69.

PLW3™ or W3 FORMLOK™

- 6½ in. TOTAL SLAB DEPTH
- Normal Weight Concrete
- 1 Hour Fire Rating

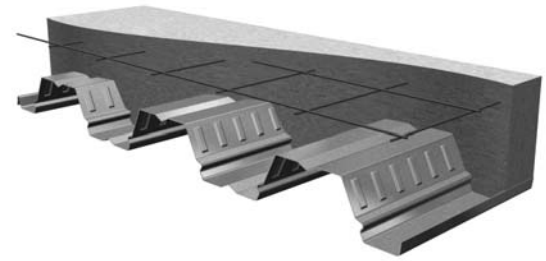

Maximum Unshored Clear Span (ft-in.)

Deck Gage	Number of Deck Spans		
	1	2	3
22	8'-10"	8'-5"	9'-6"
21	9'-7"	10'-3"	10'-9"
20	10'-3"	11'-0"	11'-5"
19	11'-2"	12'-2"	12'-8"
18	11'-6"	13'-3"	13'-6"
16	12'-2"	14'-9"	14'-2"

Shoring is required for spans greater than those shown above. See Footnote 1 on page 69 for required bearing.

Concrete Properties

Density (pcf)	Uniform Weight (psf)	Uniform Volume (yd ³ /100 ft ²)	Compressive Strength, f' _c (psi)
145	60.4	1.543	3000

Notes:

1. Volumes and weights do not include allowance for deflection.
2. Weights are for concrete only and do not include weight of steel deck.
3. Total slab depth is nominal depth from top of concrete to bottom of steel deck.

Allowable Superimposed Loads (psf)

Deck Gage	Number of Deck Spans	Span (ft-in.)														
		8'-0"	8'-6"	9'-0"	9'-6"	10'-0"	10'-6"	11'-0"	11'-6"	12'-0"	12'-6"	13'-0"	13'-6"	14'-0"	15'-0"	16'-0"
22	1	331	299	215	192	171	153	138	124	111	100	90	81	73	59	47
	2	331	242	215	192	171	153	138	124	111	100	90	81	73	59	47
	3	331	242	215	192	171	153	138	124	111	100	90	81	73	59	47
21	1	357	323	293	268	189	170	153	138	125	113	102	92	83	68	55
	2	357	323	293	268	246	170	153	138	125	113	102	92	83	68	55
	3	357	323	293	268	246	170	153	138	125	113	102	92	83	68	55
20	1	381	345	313	286	263	185	167	151	137	124	113	102	93	77	63
	2	381	345	313	286	263	242	224	151	137	124	113	102	93	77	63
	3	381	345	313	286	263	242	224	151	137	124	113	102	93	77	63
19	1	400	389	354	323	297	274	253	178	162	147	134	123	112	94	78
	2	400	389	354	323	297	274	253	235	219	147	134	123	112	94	78
	3	400	389	354	323	297	274	253	235	219	205	134	123	112	94	78
18	1	400	400	391	358	328	303	280	260	184	169	154	141	130	109	92
	2	400	400	391	358	328	303	280	260	242	226	212	141	130	109	92
	3	400	400	391	358	328	303	280	260	242	226	212	199	130	109	92
16	1	400	400	400	400	391	360	333	310	288	211	194	179	165	140	120
	2	400	400	400	400	391	360	333	310	288	269	252	237	223	140	120
	3	400	400	400	400	391	360	333	310	288	269	252	237	223	140	120

See footnotes on page 69.

Shoring required in shaded areas to right of heavy line.

Allowable Diaphragm Shear Strengths, q (plf)

Attachment Pattern	Deck Gage	Span (ft-in.)															
		8'-0"	8'-6"	9'-0"	9'-6"	10'-0"	10'-6"	11'-0"	11'-6"	12'-0"	12'-6"	13'-0"	13'-6"	14'-0"	15'-0"	16'-0"	
36/3	22	q	2323	2311	2300	2291	2282	2274	2267	2261	2255	2250	2245	2240	2236	2228	2221
	21	q	2323	2309	2298	2287	2278	2269	2261	2254	2248	2242	2236	2231	2226	2218	2210
	20	q	2325	2310	2298	2286	2276	2267	2258	2250	2243	2237	2231	2225	2220	2211	2203
	19	q	2336	2319	2304	2290	2278	2268	2258	2249	2240	2233	2226	2219	2213	2202	2193
	18	q	2352	2332	2315	2300	2286	2274	2263	2252	2243	2234	2226	2219	2212	2200	2189
	16	q	2396	2372	2351	2332	2314	2299	2285	2272	2260	2249	2239	2230	2221	2206	2192
36/4	22	q	2425	2403	2383	2366	2350	2336	2323	2311	2300	2290	2281	2272	2264	2250	2237
	21	q	2446	2422	2400	2380	2363	2347	2333	2320	2308	2297	2286	2277	2268	2252	2239
	20	q	2468	2441	2417	2396	2377	2360	2345	2330	2317	2305	2294	2284	2274	2257	2242
	19	q	2518	2487	2460	2435	2413	2393	2374	2358	2342	2328	2315	2303	2292	2272	2254
	18	q	2571	2536	2505	2477	2451	2428	2408	2389	2371	2355	2340	2327	2314	2291	2271
	16	q	2691	2647	2607	2572	2540	2512	2486	2462	2440	2420	2402	2385	2369	2340	2315

See footnotes on page 69.

PLW3™ or W3 FORMLOK™

- 7½ in. TOTAL SLAB DEPTH
- Normal Weight Concrete
- 2 Hour Fire Rating

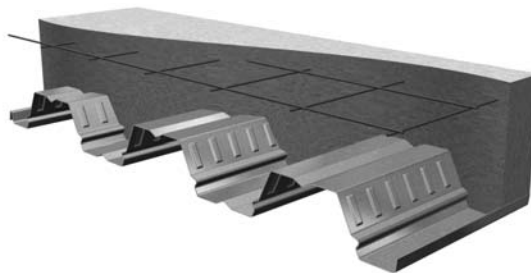

Maximum Unshored Clear Span (ft.-in.)

Deck Gage	Number of Deck Spans		
	1	2	3
22	8'-3"	7'-4"	8'-4"
21	8'-11"	8'-11"	10'-1"
20	9'-7"	10'-4"	10'-8"
19	10'-6"	11'-5"	11'-10"
18	11'-0"	12'-5"	12'-10"
16	11'-8"	13'-10"	13'-8"

Concrete Properties

Density (pcf)	Uniform Weight (psf)	Uniform Volume (yd ³ /100 ft ²)	Compressive Strength, f' _c (psi)
145	72.5	1.852	3000

Notes:

1. Volumes and weights do not include allowance for deflection.
2. Weights are for concrete only and do not include weight of steel deck.
3. Total slab depth is nominal depth from top of concrete to bottom of steel deck.

Shoring is required for spans greater than those shown above. See Footnote 1 on page 69 for required bearing.

Allowable Superimposed Loads (psf)

Deck Gage	Number of Deck Spans	Span (ft.-in.)															
		8'-0"	8'-6"	9'-0"	9'-6"	10'-0"	10'-6"	11'-0"	11'-6"	12'-0"	12'-6"	13'-0"	13'-6"	14'-0"	15'-0"	16'-0"	
22	1	388	283	251	224	200	179	161	144	130	117	105	95	85	69	55	
	2	320	283	251	224	200	179	161	144	130	117	105	95	85	69	55	
	3	320	283	251	224	200	179	161	144	130	117	105	95	85	69	55	
21	1	400	378	276	247	221	198	179	161	145	131	119	107	97	79	64	
	2	400	378	344	247	221	198	179	161	145	131	119	107	97	79	64	
	3	400	378	344	247	221	198	179	161	145	131	119	107	97	79	64	
20	1	400	400	367	335	240	216	195	176	160	145	131	119	108	89	73	
	2	400	400	367	335	308	216	195	176	160	145	131	119	108	89	73	
	3	400	400	367	335	308	284	195	176	160	145	131	119	108	89	73	
19	1	400	400	400	378	347	320	228	207	188	171	156	143	130	109	91	
	2	400	400	400	378	347	320	296	207	188	171	156	143	130	109	91	
	3	400	400	400	378	347	320	296	275	188	171	156	143	130	109	91	
18	1	400	400	400	400	384	354	327	236	215	196	180	164	151	127	107	
	2	400	400	400	400	384	354	327	304	283	196	180	164	151	127	107	
	3	400	400	400	400	384	354	327	304	283	264	180	164	151	127	107	
16	1	400	400	400	400	400	400	389	361	267	245	225	208	191	163	139	
	2	400	400	400	400	400	400	389	361	336	314	294	276	191	163	139	
	3	400	400	400	400	400	400	389	361	336	314	294	276	191	163	139	

See footnotes on page 69.

Shoring required in shaded areas to right of heavy line.

Allowable Diaphragm Shear Strengths, q (plf)

Attachment Pattern	Deck Gage	Span (ft.-in.)															
		8'-0"	8'-6"	9'-0"	9'-6"	10'-0"	10'-6"	11'-0"	11'-6"	12'-0"	12'-6"	13'-0"	13'-6"	14'-0"	15'-0"	16'-0"	
36/3	22	q	2801	2789	2778	2769	2760	2753	2745	2739	2733	2728	2723	2718	2714	2706	2699
	21	q	2801	2787	2776	2765	2756	2747	2739	2732	2726	2720	2714	2709	2704	2696	2688
	20	q	2803	2789	2776	2764	2754	2745	2736	2729	2721	2715	2709	2703	2698	2689	2681
	19	q	2814	2797	2782	2769	2757	2746	2736	2727	2718	2711	2704	2697	2691	2680	2671
	18	q	2830	2811	2794	2778	2765	2752	2741	2731	2721	2713	2705	2697	2690	2678	2667
	16	q	2874	2850	2829	2810	2793	2777	2763	2750	2738	2728	2717	2708	2700	2684	2670
36/4	22	q	2903	2881	2861	2844	2828	2814	2801	2789	2778	2768	2759	2750	2742	2728	2715
	21	q	2924	2900	2878	2859	2841	2825	2811	2798	2786	2775	2765	2755	2746	2731	2717
	20	q	2946	2919	2896	2875	2856	2838	2823	2808	2795	2783	2772	2762	2752	2735	2720
	19	q	2997	2966	2938	2913	2891	2871	2853	2836	2821	2807	2794	2782	2770	2750	2733
	18	q	3050	3014	2983	2955	2929	2907	2886	2867	2849	2833	2819	2805	2792	2769	2749
	16	q	3169	3125	3085	3050	3019	2990	2964	2940	2918	2898	2880	2863	2847	2818	2793

See footnotes on page 69.

PLW3™ or W3 FORMLOK™

- 5 in. TOTAL SLAB DEPTH
- Light Weight Concrete

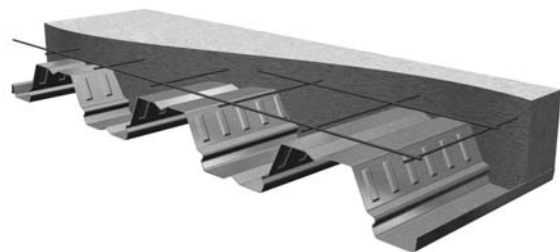

Maximum Unshored Clear Span (ft-in.)

Deck Gage	Number of Deck Spans		
	1	2	3
22	11'-1"	11'-11"	12'-4"
21	12'-1"	12'-9"	13'-3"
20	12'-5"	13'-6"	14'-0"
19	12'-11"	15'-0"	15'-1"
18	13'-3"	16'-3"	15'-7"
16	14'-0"	17'-5"	16'-4"

Shoring is required for spans greater than those shown above. See Footnote 1 on page 69 for required bearing.

Concrete Properties

Density (pcf)	Uniform Weight (psf)	Uniform Volume (yd ³ /100 ft ²)	Compressive Strength, f' _c (psi)
110	32.1	1.080	3000

Notes:

1. Volumes and weights do not include allowance for deflection.
2. Weights are for concrete only and do not include weight of steel deck.
3. Total slab depth is nominal depth from top of concrete to bottom of steel deck.

Allowable Superimposed Loads (psf)

Deck Gage	Number of Deck Spans	Span (ft-in.)															
		8'-0"	8'-6"	9'-0"	9'-6"	10'-0"	10'-6"	11'-0"	11'-6"	12'-0"	12'-6"	13'-0"	13'-6"	14'-0"	15'-0"	16'-0"	
22	1	254	229	208	190	175	161	149	107	97	89	81	74	68	57	48	
	2	254	229	208	190	175	161	149	138	97	89	81	74	68	57	48	
	3	254	229	208	190	175	161	149	138	129	89	81	74	68	57	48	
21	1	274	248	225	206	189	174	161	150	140	99	90	83	76	64	55	
	2	274	248	225	206	189	174	161	150	140	130	90	83	76	64	55	
	3	274	248	225	206	189	174	161	150	140	130	120	83	76	64	55	
20	1	294	265	241	220	202	187	172	155	140	108	99	91	84	71	60	
	2	294	265	241	220	202	187	172	155	140	127	115	105	84	71	60	
	3	294	265	241	220	202	187	172	155	140	127	115	105	96	71	60	
19	1	333	301	274	250	230	212	191	172	156	141	116	107	99	85	71	
	2	333	301	274	250	230	212	191	172	156	141	129	117	106	87	71	
	3	333	301	274	250	230	212	191	172	156	141	129	117	106	87	71	
18	1	370	334	304	278	255	230	207	187	170	154	140	122	112	91	75	
	2	370	334	304	278	255	230	207	187	170	154	140	125	112	91	75	
	3	370	334	304	278	255	230	207	187	170	154	140	125	112	91	75	
16	1	400	400	365	331	296	266	240	217	197	175	155	139	124	101	83	
	2	400	400	365	331	296	266	240	217	197	175	155	139	124	101	83	
	3	400	400	365	331	296	266	240	217	197	175	155	139	124	101	83	

See footnotes on page 69.

Shoring required in shaded areas to right of heavy line.

Allowable Diaphragm Shear Strengths, q (plf)

Attachment Pattern	Deck Gage	Span (ft-in.)															
		8'-0"	8'-6"	9'-0"	9'-6"	10'-0"	10'-6"	11'-0"	11'-6"	12'-0"	12'-6"	13'-0"	13'-6"	14'-0"	15'-0"	16'-0"	
36/3	22	q	1281	1269	1259	1249	1240	1233	1226	1219	1213	1208	1203	1198	1194	1186	1179
	21	q	1281	1268	1256	1245	1236	1227	1220	1212	1206	1200	1194	1189	1185	1176	1168
	20	q	1283	1269	1256	1244	1234	1225	1216	1209	1202	1195	1189	1183	1178	1169	1161
	19	q	1294	1277	1262	1249	1237	1226	1216	1207	1199	1191	1184	1177	1171	1160	1151
	18	q	1310	1291	1274	1258	1245	1232	1221	1211	1201	1193	1185	1177	1170	1158	1147
	16	q	1354	1330	1309	1290	1273	1257	1243	1230	1218	1208	1198	1188	1180	1164	1151
36/4	22	q	1383	1361	1342	1324	1308	1294	1281	1269	1258	1248	1239	1230	1222	1208	1195
	21	q	1404	1380	1358	1339	1321	1305	1291	1278	1266	1255	1245	1235	1226	1211	1197
	20	q	1426	1399	1376	1355	1336	1318	1303	1289	1276	1263	1252	1242	1233	1215	1200
	19	q	1477	1446	1418	1393	1371	1351	1333	1316	1301	1287	1274	1262	1250	1230	1213
	18	q	1530	1494	1463	1435	1410	1387	1366	1347	1329	1313	1299	1285	1272	1249	1229
	16	q	1649	1605	1566	1530	1499	1470	1444	1420	1399	1379	1360	1343	1327	1298	1273

See footnotes on page 69.

PLW3™ or W3 FORMLOK™

- 5½ in. TOTAL SLAB DEPTH
- Light Weight Concrete
- 1 Hour Fire Rating

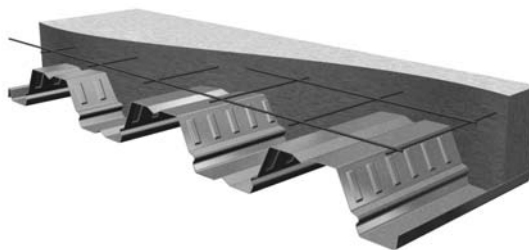

Maximum Unshored Clear Span (ft-in.)

Deck Gage	Number of Deck Spans		
	1	2	3
22	10'-7"	11'-6"	11'-11"
21	11'-6"	12'-4"	12'-9"
20	12'-1"	13'-0"	13'-6"
19	12'-6"	14'-5"	14'-8"
18	12'-11"	15'-8"	15'-1"
16	13'-7"	16'-11"	15'-11"

Concrete Properties

Density (pcf)	Uniform Weight (psf)	Uniform Volume (yd³/100 ft²)	Compressive Strength, f _c (psi)
110	36.7	1.235	3000

Notes:

1. Volumes and weights do not include allowance for deflection.
2. Weights are for concrete only and do not include weight of steel deck.
3. Total slab depth is nominal depth from top of concrete to bottom of steel deck.

Shoring is required for spans greater than those shown above. See Footnote 1 on page 69 for required bearing.

Allowable Superimposed Loads (psf)

Deck Gage	Number of Deck Spans	Span (ft-in.)															
		8'-0"	8'-6"	9'-0"	9'-6"	10'-0"	10'-6"	11'-0"	11'-6"	12'-0"	12'-6"	13'-0"	13'-6"	14'-0"	15'-0"	16'-0"	
22	1	278	251	228	209	191	176	128	116	106	96	88	80	74	62	52	
	2	278	251	228	209	191	176	163	152	106	96	88	80	74	62	52	
	3	278	251	228	209	191	176	163	152	106	96	88	80	74	62	52	
21	1	300	271	247	225	207	191	177	164	117	107	98	90	82	69	59	
	2	300	271	247	225	207	191	177	164	153	107	98	90	82	69	59	
	3	300	271	247	225	207	191	177	164	153	143	98	90	82	69	59	
20	1	321	290	264	241	221	204	189	175	163	117	107	98	90	77	65	
	2	321	290	264	241	221	204	189	175	163	152	143	98	90	77	65	
	3	321	290	264	241	221	204	189	175	163	152	143	134	90	77	65	
19	1	363	328	298	273	250	231	214	198	185	173	125	116	107	91	78	
	2	363	328	298	273	250	231	214	198	185	173	162	152	138	91	78	
	3	363	328	298	273	250	231	214	198	185	173	162	152	138	91	78	
18	1	400	364	331	302	277	256	237	220	205	191	143	132	122	105	90	
	2	400	364	331	302	277	256	237	220	205	191	176	161	146	119	90	
	3	400	364	331	302	277	256	237	220	205	191	176	161	146	119	90	
16	1	400	400	395	361	332	306	283	263	243	222	201	179	152	131	108	
	2	400	400	395	361	332	306	283	263	243	222	201	179	161	131	108	
	3	400	400	395	361	332	306	283	263	243	222	201	179	161	131	108	

See footnotes on page 69.

Shoring required in shaded areas to right of heavy line.

Allowable Diaphragm Shear Strengths, q (plf)

Attachment Pattern	Deck Gage	Span (ft-in.)															
		8'-0"	8'-6"	9'-0"	9'-6"	10'-0"	10'-6"	11'-0"	11'-6"	12'-0"	12'-6"	13'-0"	13'-6"	14'-0"	15'-0"	16'-0"	
36/3	22	q	1439	1427	1417	1407	1398	1391	1384	1377	1371	1366	1361	1356	1352	1344	1337
	21	q	1439	1426	1414	1403	1394	1385	1378	1370	1364	1358	1352	1347	1342	1334	1326
	20	q	1441	1427	1414	1402	1392	1383	1374	1367	1360	1353	1347	1341	1336	1327	1319
	19	q	1452	1435	1420	1407	1395	1384	1374	1365	1357	1349	1342	1335	1329	1318	1309
	18	q	1468	1449	1432	1416	1403	1390	1379	1369	1359	1351	1343	1335	1328	1316	1305
	16	q	1512	1488	1467	1448	1431	1415	1401	1388	1376	1366	1356	1346	1338	1322	1309
36/4	22	q	1541	1519	1500	1482	1466	1452	1439	1427	1416	1406	1397	1388	1380	1366	1353
	21	q	1562	1538	1516	1497	1479	1463	1449	1436	1424	1413	1403	1393	1384	1369	1355
	20	q	1584	1557	1534	1513	1494	1476	1461	1447	1433	1421	1410	1400	1391	1373	1358
	19	q	1635	1604	1576	1551	1529	1509	1491	1474	1459	1445	1432	1420	1408	1388	1371
	18	q	1688	1652	1621	1593	1568	1545	1524	1505	1487	1471	1457	1443	1430	1407	1387
	16	q	1807	1763	1724	1688	1657	1628	1602	1578	1557	1536	1518	1501	1485	1456	1431

See footnotes on page 69.

PLW3™ or W3 FORMLOK™

- 6¼ in. TOTAL SLAB DEPTH
- Light Weight Concrete
- 2 Hour Fire Rating

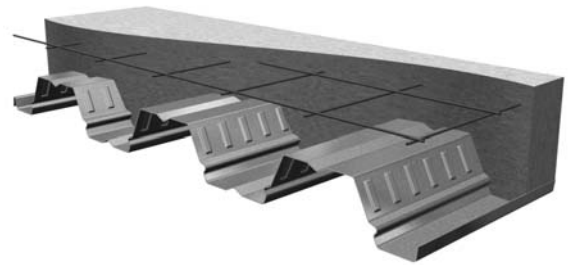

Maximum Unshored Clear Span (ft-in.)

Deck Gage	Number of Deck Spans		
	1	2	3
22	10'-0"	10'-7"	11'-3"
21	10'-10"	11'-8"	12'-1"
20	11'-7"	12'-4"	12'-9"
19	12'-1"	13'-8"	14'-1"
18	12'-5"	14'-10"	14'-7"
16	13'-1"	16'-4"	15'-4"

Shoring is required for spans greater than those shown above. See Footnote 1 on page 69 for required bearing.

Concrete Properties

Density (pcf)	Uniform Weight (psf)	Uniform Volume (yd ³ /100 ft ²)	Compressive Strength, f' _c (psi)
110	43.5	1.466	3000

Notes:

1. Volumes and weights do not include allowance for deflection.
2. Weights are for concrete only and do not include weight of steel deck.
3. Total slab depth is nominal depth from top of concrete to bottom of steel deck.

Allowable Superimposed Loads (psf)

Deck Gage	Number of Deck Spans	Span (ft-in.)															
		8'-0"	8'-6"	9'-0"	9'-6"	10'-0"	10'-6"	11'-0"	11'-6"	12'-0"	12'-6"	13'-0"	13'-6"	14'-0"	15'-0"	16'-0"	
22	1	317	287	261	238	219	160	145	132	120	109	100	91	83	70	58	
	2	317	287	261	238	219	202	145	132	120	109	100	91	83	70	58	
	3	317	287	261	238	219	202	145	132	120	109	100	91	83	70	58	
21	1	342	309	281	257	236	218	160	145	133	121	111	101	93	78	66	
	2	342	309	281	257	236	218	201	187	133	121	111	101	93	78	66	
	3	342	309	281	257	236	218	201	187	174	121	111	101	93	78	66	
20	1	366	330	300	275	252	232	215	200	144	132	121	111	102	86	73	
	2	366	330	300	275	252	232	215	200	186	132	121	111	102	86	73	
	3	366	330	300	275	252	232	215	200	186	174	121	111	102	86	73	
19	1	400	373	339	310	285	263	243	226	210	154	142	131	120	103	88	
	2	400	373	339	310	285	263	243	226	210	196	184	173	120	103	88	
	3	400	373	339	310	285	263	243	226	210	196	184	173	163	103	88	
18	1	400	400	375	343	315	290	269	250	232	175	161	149	137	118	102	
	2	400	400	375	343	315	290	269	250	232	217	203	191	180	118	102	
	3	400	400	375	343	315	290	269	250	232	217	203	191	180	118	102	
16	1	400	400	400	400	375	346	320	297	277	259	242	185	171	148	128	
	2	400	400	400	400	375	346	320	297	277	259	242	228	214	186	153	
	3	400	400	400	400	375	346	320	297	277	259	242	228	214	186	128	

See footnotes on page 69.

Shoring required in shaded areas to right of heavy line.

Allowable Diaphragm Shear Strengths, q (plf)

Attachment Pattern	Deck Gage	Span (ft-in.)															
		8'-0"	8'-6"	9'-0"	9'-6"	10'-0"	10'-6"	11'-0"	11'-6"	12'-0"	12'-6"	13'-0"	13'-6"	14'-0"	15'-0"	16'-0"	
36/3	22	q	1676	1664	1653	1644	1635	1628	1621	1614	1608	1603	1598	1593	1589	1581	1574
	21	q	1676	1663	1651	1640	1631	1622	1614	1607	1601	1595	1589	1584	1579	1571	1563
	20	q	1678	1664	1651	1639	1629	1620	1611	1604	1597	1590	1584	1578	1573	1564	1556
	19	q	1689	1672	1657	1644	1632	1621	1611	1602	1594	1586	1579	1572	1566	1555	1546
	18	q	1705	1686	1669	1653	1640	1627	1616	1606	1596	1588	1580	1572	1565	1553	1542
	16	q	1749	1725	1704	1685	1668	1652	1638	1625	1613	1603	1593	1583	1575	1559	1546
36/4	22	q	1778	1756	1737	1719	1703	1689	1676	1664	1653	1643	1634	1625	1617	1603	1590
	21	q	1799	1775	1753	1734	1716	1700	1686	1673	1661	1650	1640	1630	1621	1606	1592
	20	q	1821	1794	1771	1750	1731	1713	1698	1684	1670	1658	1647	1637	1627	1610	1595
	19	q	1872	1841	1813	1788	1766	1746	1728	1711	1696	1682	1669	1657	1645	1625	1608
	18	q	1925	1889	1858	1830	1805	1782	1761	1742	1724	1708	1694	1680	1667	1644	1624
	16	q	2044	2000	1960	1925	1894	1865	1839	1815	1793	1773	1755	1738	1722	1693	1668

See footnotes on page 69.

PLW3™ or W3 FORMLOK™

- 7¼ in. TOTAL SLAB DEPTH
- Light Weight Concrete
- 3 Hour Fire Rating

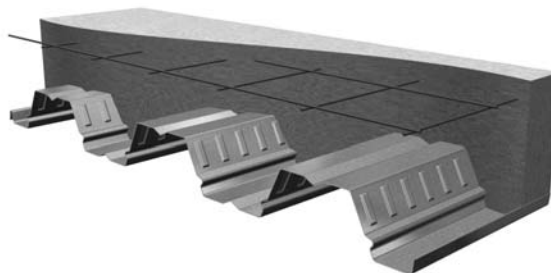

Maximum Unshored Clear Span (ft.-in.)

Deck Gage	Number of Deck Spans		
	1	2	3
22	9'-4"	9'-4"	10'-7"
21	10'-2"	10'-11"	11'-4"
20	10'-11"	11'-7"	12'-0"
19	11'-7"	12'-10"	13'-4"
18	11'-11"	13'-11"	13'-11"
16	12'-7"	15'-7"	14'-8"

Concrete Properties

Density (pcf)	Uniform Weight (psf)	Uniform Volume (yd ³ /100 ft ²)	Compressive Strength, f' _c (psi)
110	52.7	1.775	3000

Notes:

1. Volumes and weights do not include allowance for deflection.
2. Weights are for concrete only and do not include weight of steel deck.
3. Total slab depth is nominal depth from top of concrete to bottom of steel deck.

Shoring is required for spans greater than those shown above. See Footnote 1 on page 69 for required bearing.

Allowable Superimposed Loads (psf)

Deck Gage	Number of Deck Spans	Span (ft.-in.)															
		8'-0"	8'-6"	9'-0"	9'-6"	10'-0"	10'-6"	11'-0"	11'-6"	12'-0"	12'-6"	13'-0"	13'-6"	14'-0"	15'-0"	16'-0"	
22	1	373	337	307	231	208	188	170	154	140	128	117	107	97	82	68	
	2	373	337	307	231	208	188	170	154	140	128	117	107	97	82	68	
	3	373	337	307	231	208	188	170	154	140	128	117	107	97	82	68	
21	1	400	364	331	302	278	206	187	170	155	142	130	119	109	92	77	
	2	400	364	331	302	278	256	187	170	155	142	130	119	109	92	77	
	3	400	364	331	302	278	256	237	170	155	142	130	119	109	92	77	
20	1	400	388	353	323	296	273	203	185	169	155	142	130	119	101	86	
	2	400	388	353	323	296	273	253	235	169	155	142	130	119	101	86	
	3	400	388	353	323	296	273	253	235	219	155	142	130	119	101	86	
19	1	400	400	399	364	334	308	285	265	197	181	166	153	141	120	103	
	2	400	400	399	364	334	308	285	265	247	231	166	153	141	120	103	
	3	400	400	399	364	334	308	285	265	247	231	216	153	141	120	103	
18	1	400	400	400	400	369	341	315	293	222	204	188	174	161	138	118	
	2	400	400	400	400	369	341	315	293	273	255	239	224	161	138	118	
	3	400	400	400	400	369	341	315	293	273	255	239	224	161	138	118	
16	1	400	400	400	400	400	400	375	348	324	303	233	215	200	172	150	
	2	400	400	400	400	400	400	375	348	324	303	283	266	251	223	150	
	3	400	400	400	400	400	400	375	348	324	303	283	266	251	172	150	

See footnotes on page 69.

Shoring required in shaded areas to right of heavy line.

Allowable Diaphragm Shear Strengths, q (plf)

Attachment Pattern	Deck Gage	q	Span (ft.-in.)															
			8'-0"	8'-6"	9'-0"	9'-6"	10'-0"	10'-6"	11'-0"	11'-6"	12'-0"	12'-6"	13'-0"	13'-6"	14'-0"	15'-0"	16'-0"	
36/3	22	q	1992	1980	1969	1960	1951	1944	1937	1930	1924	1919	1914	1909	1905	1897	1890	
	21	q	1992	1978	1967	1956	1947	1938	1930	1923	1917	1911	1905	1900	1895	1887	1879	
	20	q	1994	1980	1967	1955	1945	1936	1927	1920	1912	1906	1900	1894	1889	1880	1872	
	19	q	2005	1988	1973	1960	1948	1937	1927	1918	1909	1902	1895	1888	1882	1871	1862	
	18	q	2021	2002	1985	1969	1956	1943	1932	1922	1912	1904	1896	1888	1881	1869	1858	
	16	q	2065	2041	2020	2001	1984	1968	1954	1941	1929	1919	1909	1899	1891	1875	1862	
36/4	22	q	2094	2072	2052	2035	2019	2005	1992	1980	1969	1959	1950	1941	1933	1919	1906	
	21	q	2115	2091	2069	2050	2032	2016	2002	1989	1977	1966	1956	1946	1937	1922	1908	
	20	q	2137	2110	2087	2066	2047	2029	2014	1999	1986	1974	1963	1953	1943	1926	1911	
	19	q	2188	2157	2129	2104	2082	2062	2044	2027	2012	1998	1985	1973	1961	1941	1924	
	18	q	2241	2205	2174	2146	2120	2098	2077	2058	2040	2024	2010	1996	1983	1960	1940	
	16	q	2360	2316	2276	2241	2210	2181	2155	2131	2109	2089	2071	2054	2038	2009	1984	

See footnotes on page 69.

PLW3™ or W3 FORMLOK™

■ Without Concrete Fill



Allowable Uniform Loads (psf)

SPAN	DECK GAGE	CRITERIA	SPAN (ft-in.)															
			6'-0"	6'-6"	7'-0"	7'-6"	8'-0"	8'-6"	9'-0"	9'-6"	10'-0"	10'-6"	11'-0"	12'-0"	13'-0"	14'-0"	15'-0"	16'-0"
SINGLE	22	Stress	218	186	160	140	123	109	97	87	79	71	65	55	47	40	35	31
		L/360	149	117	94	76	63	52	44	38	32	28	24	19	15	12	10	8
		L/240	◆◆◆	176	141	115	94	79	66	56	48	42	36	28	22	18	14	12
	21	L/180	◆◆◆	◆◆◆	◆◆◆	◆◆◆	◆◆◆	105	88	75	64	56	48	37	29	23	19	16
		Stress	252	214	185	161	142	125	112	100	91	82	75	63	54	46	40	35
		L/360	167	131	105	85	70	59	49	42	36	31	27	21	16	13	11	9
	20	L/240	250	197	158	128	106	88	74	63	54	47	41	31	25	20	16	13
		L/180	◆◆◆	◆◆◆	◆◆◆	◆◆◆	141	117	99	84	72	62	54	42	33	26	21	18
		Stress	283	241	208	181	159	141	126	113	102	93	84	71	60	52	45	40
	19	L/360	184	145	116	94	78	65	54	46	40	34	30	23	18	14	12	10
		L/240	276	217	174	141	116	97	82	69	60	51	45	34	27	22	18	15
		L/180	◆◆◆	◆◆◆	◆◆◆	◆◆◆	155	129	109	93	79	69	60	46	36	29	24	19
18	Stress	300	300	260	226	199	176	157	141	127	115	105	88	75	65	57	50	
	L/360	216	170	136	111	91	76	64	54	47	40	35	27	21	17	14	11	
	L/240	◆◆◆	255	204	166	137	114	96	82	70	61	53	41	32	26	21	17	
17	L/180	◆◆◆	◆◆◆	◆◆◆	221	182	152	128	109	93	81	70	54	43	34	28	23	
	Stress	300	300	300	267	235	208	186	167	150	136	124	104	89	77	67	59	
	L/360	246	193	155	126	104	86	73	62	53	46	40	31	24	19	16	13	
16	L/240	◆◆◆	290	232	189	156	130	109	93	80	69	60	46	36	29	24	19	
	L/180	◆◆◆	◆◆◆	◆◆◆	252	207	173	146	124	106	92	80	61	48	39	31	26	
	Stress	300	300	300	300	300	268	239	215	194	176	160	134	115	99	86	76	
15	L/360	◆◆◆	242	193	157	130	108	91	77	66	57	50	38	30	24	20	16	
	L/240	◆◆◆	◆◆◆	290	236	194	162	137	116	100	86	75	58	45	36	29	24	
	L/180	◆◆◆	◆◆◆	◆◆◆	◆◆◆	259	216	182	155	133	115	100	77	60	48	39	32	

See footnotes on page 69.

PLW3™ or W3 FORMLOK™

■ Without Concrete Fill



Allowable Uniform Loads (psf)

SPAN	DECK GAGE	CRITERIA	SPAN (ft-in.)																	
			6'-0"	6'-6"	7'-0"	7'-6"	8'-0"	8'-6"	9'-0"	9'-6"	10'-0"	10'-6"	11'-0"	12'-0"	13'-0"	14'-0"	15'-0"	16'-0"		
DOUBLE	22	Stress	228	194	167	146	128	113	101	91	82	74	68	57	49	42	36	32		
		L/360	◆◆◆	◆◆◆	◆◆◆	◆◆◆	◆◆◆	◆◆◆	◆◆◆	◆◆◆	90	78	67	58	45	35	28	19		
		L/240	◆◆◆	◆◆◆	◆◆◆	◆◆◆	◆◆◆	◆◆◆	◆◆◆	◆◆◆	◆◆◆	◆◆◆	◆◆◆	◆◆◆	◆◆◆	◆◆◆	◆◆◆	34	28	
		L/180	◆◆◆	◆◆◆	◆◆◆	◆◆◆	◆◆◆	◆◆◆	◆◆◆	◆◆◆	◆◆◆	◆◆◆	◆◆◆	◆◆◆	◆◆◆	◆◆◆	◆◆◆	◆◆◆	◆◆◆	
	21	Stress	261	222	192	167	147	130	116	104	94	85	78	65	56	48	42	37		
		L/360	◆◆◆	◆◆◆	◆◆◆	◆◆◆	◆◆◆	◆◆◆	◆◆◆	◆◆◆	101	87	75	65	50	40	32	26	21	
		L/240	◆◆◆	◆◆◆	◆◆◆	◆◆◆	◆◆◆	◆◆◆	◆◆◆	◆◆◆	◆◆◆	◆◆◆	◆◆◆	◆◆◆	◆◆◆	◆◆◆	◆◆◆	47	39	32
		L/180	◆◆◆	◆◆◆	◆◆◆	◆◆◆	◆◆◆	◆◆◆	◆◆◆	◆◆◆	◆◆◆	◆◆◆	◆◆◆	◆◆◆	◆◆◆	◆◆◆	◆◆◆	◆◆◆	◆◆◆	◆◆◆
	20	Stress	293	250	216	188	165	146	130	117	106	96	87	73	62	54	47	41		
		L/360	◆◆◆	◆◆◆	◆◆◆	◆◆◆	◆◆◆	◆◆◆	◆◆◆	◆◆◆	111	96	83	72	55	44	35	28	23	
		L/240	◆◆◆	◆◆◆	◆◆◆	◆◆◆	◆◆◆	◆◆◆	◆◆◆	◆◆◆	◆◆◆	◆◆◆	◆◆◆	◆◆◆	◆◆◆	◆◆◆	◆◆◆	52	42	35
		L/180	◆◆◆	◆◆◆	◆◆◆	◆◆◆	◆◆◆	◆◆◆	◆◆◆	◆◆◆	◆◆◆	◆◆◆	◆◆◆	◆◆◆	◆◆◆	◆◆◆	◆◆◆	◆◆◆	◆◆◆	◆◆◆
19	Stress	300	300	266	232	204	180	161	144	130	118	108	91	77	67	58	51			
	L/360	◆◆◆	◆◆◆	◆◆◆	◆◆◆	◆◆◆	◆◆◆	◆◆◆	◆◆◆	154	131	112	97	84	65	51	41	33	27	
	L/240	◆◆◆	◆◆◆	◆◆◆	◆◆◆	◆◆◆	◆◆◆	◆◆◆	◆◆◆	◆◆◆	◆◆◆	◆◆◆	◆◆◆	◆◆◆	◆◆◆	77	61	50	41	
	L/180	◆◆◆	◆◆◆	◆◆◆	◆◆◆	◆◆◆	◆◆◆	◆◆◆	◆◆◆	◆◆◆	◆◆◆	◆◆◆	◆◆◆	◆◆◆	◆◆◆	◆◆◆	◆◆◆	◆◆◆	◆◆◆	
18	Stress	300	300	300	273	240	213	190	170	154	139	127	107	91	78	68	60			
	L/360	◆◆◆	◆◆◆	◆◆◆	◆◆◆	◆◆◆	◆◆◆	◆◆◆	◆◆◆	208	175	149	128	110	96	74	58	47	38	31
	L/240	◆◆◆	◆◆◆	◆◆◆	◆◆◆	◆◆◆	◆◆◆	◆◆◆	◆◆◆	◆◆◆	◆◆◆	◆◆◆	◆◆◆	◆◆◆	◆◆◆	87	70	57	47	
	L/180	◆◆◆	◆◆◆	◆◆◆	◆◆◆	◆◆◆	◆◆◆	◆◆◆	◆◆◆	◆◆◆	◆◆◆	◆◆◆	◆◆◆	◆◆◆	◆◆◆	◆◆◆	◆◆◆	◆◆◆	◆◆◆	◆◆◆
16	Stress	300	300	300	300	300	267	239	214	193	175	160	134	114	99	86	75			
	L/360	◆◆◆	◆◆◆	◆◆◆	◆◆◆	◆◆◆	◆◆◆	◆◆◆	◆◆◆	260	219	186	160	138	120	92	73	58	47	39
	L/240	◆◆◆	◆◆◆	◆◆◆	◆◆◆	◆◆◆	◆◆◆	◆◆◆	◆◆◆	◆◆◆	◆◆◆	◆◆◆	◆◆◆	◆◆◆	◆◆◆	109	87	71	59	
	L/180	◆◆◆	◆◆◆	◆◆◆	◆◆◆	◆◆◆	◆◆◆	◆◆◆	◆◆◆	◆◆◆	◆◆◆	◆◆◆	◆◆◆	◆◆◆	◆◆◆	◆◆◆	◆◆◆	◆◆◆	◆◆◆	◆◆◆

See footnotes on page 69.

PLW3™ or W3 FORMLOK™

■ Without Concrete Fill



Allowable Uniform Loads (psf)

SPAN	DECK GAGE	CRITERIA	SPAN (ft-in.)																
			6'-0"	6'-6"	7'-0"	7'-6"	8'-0"	8'-6"	9'-0"	9'-6"	10'-0"	10'-6"	11'-0"	12'-0"	13'-0"	14'-0"	15'-0"	16'-0"	
TRIPLE	22	Stress	285	243	209	182	160	142	127	114	103	93	85	71	61	52	46	40	
		L/360	281	221	177	144	119	99	83	71	61	52	46	35	28	22	18	15	
		L/240	◆◆◆	◆◆◆	◆◆◆	◆◆◆	◆◆◆	◆◆◆	◆◆◆	125	106	91	79	68	53	41	33	27	22
		L/180	◆◆◆	◆◆◆	◆◆◆	◆◆◆	◆◆◆	◆◆◆	◆◆◆	◆◆◆	◆◆◆	◆◆◆	◆◆◆	◆◆◆	70	55	44	36	30
	21	Stress	300	278	240	209	184	163	145	130	118	107	97	82	70	60	52	46	
		L/360	◆◆◆	247	198	161	133	111	93	79	68	59	51	39	31	25	20	17	
		L/240	◆◆◆	◆◆◆	◆◆◆	◆◆◆	◆◆◆	◆◆◆	◆◆◆	140	119	102	88	77	59	46	37	30	25
		L/180	◆◆◆	◆◆◆	◆◆◆	◆◆◆	◆◆◆	◆◆◆	◆◆◆	◆◆◆	◆◆◆	◆◆◆	◆◆◆	◆◆◆	79	62	50	40	33
	20	Stress	300	300	269	235	206	183	163	146	132	120	109	92	78	67	59	52	
		L/360	◆◆◆	272	218	177	146	122	103	87	75	65	56	43	34	27	22	18	
		L/240	◆◆◆	◆◆◆	◆◆◆	◆◆◆	◆◆◆	◆◆◆	◆◆◆	154	131	112	97	84	65	51	41	33	27
		L/180	◆◆◆	◆◆◆	◆◆◆	◆◆◆	◆◆◆	◆◆◆	◆◆◆	◆◆◆	◆◆◆	◆◆◆	◆◆◆	◆◆◆	87	68	55	44	37
19	Stress	300	300	300	290	255	226	201	181	163	148	135	113	96	83	72	64		
	L/360	◆◆◆	◆◆◆	257	209	172	143	121	103	88	76	66	51	40	32	26	21		
	L/240	◆◆◆	◆◆◆	◆◆◆	◆◆◆	◆◆◆	◆◆◆	215	181	154	132	114	99	76	60	48	39	32	
	L/180	◆◆◆	◆◆◆	◆◆◆	◆◆◆	◆◆◆	◆◆◆	◆◆◆	◆◆◆	◆◆◆	◆◆◆	◆◆◆	132	102	80	64	52	43	
18	Stress	300	300	300	300	300	266	237	213	192	174	159	133	114	98	85	75		
	L/360	◆◆◆	◆◆◆	292	237	195	163	137	117	100	86	75	58	46	36	30	24		
	L/240	◆◆◆	◆◆◆	◆◆◆	◆◆◆	293	244	206	175	150	130	113	87	68	55	44	37		
	L/180	◆◆◆	◆◆◆	◆◆◆	◆◆◆	◆◆◆	◆◆◆	◆◆◆	◆◆◆	◆◆◆	◆◆◆	173	150	116	91	73	59	49	
16	Stress	300	300	300	300	300	300	298	268	242	219	200	168	143	123	107	94		
	L/360	◆◆◆	◆◆◆	◆◆◆	296	244	204	172	146	125	108	94	72	57	46	37	31		
	L/240	◆◆◆	◆◆◆	◆◆◆	◆◆◆	◆◆◆	◆◆◆	257	219	188	162	141	109	85	68	56	46		
	L/180	◆◆◆	◆◆◆	◆◆◆	◆◆◆	◆◆◆	◆◆◆	◆◆◆	◆◆◆	◆◆◆	◆◆◆	216	188	145	114	91	74	61	

See footnotes on page 69.

Type PLW3™ FORMLOK™

- Without Concrete Fill
- 36/4 Weld Pattern at Supports
- Sidelaps connected with PunchLok II Tool



Allowable Diaphragm Shear Strengths, q (plf) and Flexibility Factors, F (in./lb. x 10⁶)

DECK GAGE	SIDELAP ATTACHMENT	SPAN (ft.-in.)									
		6'-0"	7'-0"	8'-0"	9'-0"	10'-0"	11'-0"	12'-0"	14'-0"	16'-0"	
22	VSC2 @ 24"	q	470	487	438	456	418	435	404	394	387
		F	11+36R	11.3+31R	13+26R	13+23R	14.3+20R	14.2+18R	15.3+16R	16.1+14R	16.8+12R
	VSC2 @ 12"	q	671	660	651	644	638	633	629	622	618
		F	7.8+37R	8.5+32R	9+28R	9.4+24R	9.7+22R	10+20R	10.2+18R	10.6+16R	10.9+14R
	VSC2 @ 8"	q	795	801	782	789	775	781	769	765	762
		F	6.2+38R	6.5+32R	7.1+28R	7.3+25R	7.7+23R	7.7+20R	8.1+19R	8.3+16R	8.5+14R
	VSC2 @ 4"	q	949	947	946	944	943	943	942	941	844
		F	4.2+38R	4.6+33R	4.9+29R	5.1+26R	5.3+23R	5.4+21R	5.6+19R	5.8+16R	5.9+14R
21	VSC2 @ 24"	q	564	585	525	547	501	522	485	473	464
		F	10.2+28R	10.3+24R	11.7+20R	11.7+18R	12.8+16R	12.6+14R	13.6+13R	14.3+11R	14.8+9R
	VSC2 @ 12"	q	805	791	780	772	765	759	754	747	741
		F	7.2+29R	7.7+25R	8.1+22R	8.4+19R	8.7+17R	8.9+16R	9.1+14R	9.4+12R	9.6+11R
	VSC2 @ 8"	q	952	960	937	946	928	936	922	917	914
		F	5.7+30R	6+25R	6.4+22R	6.5+20R	6.9+18R	6.9+16R	7.2+15R	7.4+13R	7.5+11R
	VSC2 @ 4"	q	1135	1133	1131	1130	1129	1128	1127	1126	979
		F	3.9+30R	4.2+26R	4.5+22R	4.7+20R	4.8+18R	4.9+16R	5+15R	5.2+13R	5.3+11R
20	VSC2 @ 24"	q	655	679	610	635	582	605	563	549	538
		F	9.3+22R	9.4+19R	10.6+16R	10.5+14R	11.5+13R	11.3+12R	12.2+10R	12.7+9R	13.1+7R
	VSC2 @ 12"	q	935	919	906	897	888	882	876	867	860
		F	6.6+24R	7+20R	7.3+17R	7.5+15R	7.8+14R	7.9+13R	8.1+12R	8.3+10R	8.5+9R
	VSC2 @ 8"	q	1107	1117	1090	1100	1079	1088	1072	1066	1062
		F	5.3+24R	5.4+21R	5.8+18R	5.9+16R	6.2+14R	6.2+13R	6.4+12R	6.6+10R	6.7+9R
	VSC2 @ 4"	q	1322	1319	1317	1316	1314	1313	1312	1311	1111
		F	3.7+24R	3.9+21R	4.1+18R	4.3+16R	4.4+15R	4.5+13R	4.5+12R	4.7+10R	4.8+9R
19	VSC2 @ 24"	q	857	888	796	828	758	789	733	714	700
		F	7.7+15R	7.6+13R	8.5+11R	8.3+10R	9.1+9R	8.8+8R	9.5+7R	9.8+6R	10+5R
	VSC2 @ 12"	q	1226	1204	1187	1173	1162	1153	1145	1133	1123
		F	5.3+16R	5.6+14R	5.8+12R	6+11R	6.1+9R	6.2+9R	6.3+8R	6.4+7R	6.5+6R
	VSC2 @ 8"	q	1458	1470	1434	1446	1418	1430	1408	1400	1394
		F	4.3+16R	4.4+14R	4.7+12R	4.7+11R	4.9+10R	4.9+9R	5.1+8R	5.2+7R	5.2+6R
	VSC2 @ 4"	q	1753	1749	1747	1744	1742	1741	1740	1738	1404
		F	3.1+16R	3.3+14R	3.4+12R	3.5+11R	3.6+10R	3.7+9R	3.7+8R	3.8+7R	3.8+6R
18	VSC2 @ 24"	q	1063	1098	984	1022	935	971	902	877	859
		F	6.4+11R	6.2+9R	6.9+8R	6.7+7R	7.3+6R	7.1+6R	7.6+5R	7.8+4R	7.9+4R
	VSC2 @ 12"	q	1524	1494	1471	1453	1438	1426	1416	1399	1386
		F	4.4+12R	4.6+10R	4.8+9R	4.9+8R	4.9+7R	5+6R	5.1+6R	5.2+5R	5.2+4R
	VSC2 @ 8"	q	1820	1835	1787	1803	1766	1782	1752	1741	1703
		F	3.6+12R	3.7+10R	3.9+9R	3.9+8R	4+7R	4+6R	4.1+6R	4.2+5R	4.3+4R
	VSC2 @ 4"	q	2210	2205	2201	2198	2195	2193	2191	2188	1703
		F	2.7+12R	2.8+10R	2.9+9R	3+8R	3+7R	3.1+6R	3.1+6R	3.2+5R	3.2+4R
16	VSC2 @ 24"	q	1389	1440	1294	1346	1234	1284	1194	1165	1142
		F	5.5+6R	5.3+5R	5.9+4R	5.7+4R	6.2+3R	6+3R	6.4+3R	6.5+2R	6.6+2R
	VSC2 @ 12"	q	1982	1948	1922	1901	1884	1870	1858	1839	1824
		F	3.8+7R	4+6R	4.1+5R	4.1+4R	4.2+4R	4.2+4R	4.3+3R	4.3+3R	4.4+2R
	VSC2 @ 8"	q	2347	2366	2310	2330	2287	2307	2271	2260	2251
		F	3.2+7R	3.2+6R	3.3+5R	3.3+4R	3.4+4R	3.4+4R	3.5+3R	3.5+3R	3.5+2R
	VSC2 @ 4"	q	2800	2794	2790	2787	2784	2782	2780	2777	2381
		F	2.4+7R	2.5+6R	2.5+5R	2.5+5R	2.6+4R	2.6+4R	2.6+3R	2.7+3R	2.7+3R

See footnotes on page 69.

Type W3™ FORMLOK™

- Without Concrete Fill
- 3/4" Weld Pattern at Supports
- Sidelaps connected with Button Punch or 1/2" Top Seam Weld

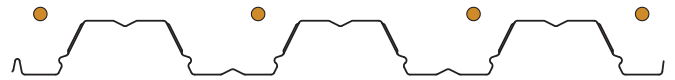

Allowable Diaphragm Shear Strengths, q (plf) and Flexibility Factors, F (in./lb. x 10⁶)

DECK GAGE	SIDELAP ATTACHMENT	SPAN (ft.-in.)										
		6'-0"	7'-0"	8'-0"	9'-0"	10'-0"	11'-0"	12'-0"	14'-0"	16'-0"		
22	BP @ 24"	q	186	170	149	140	126	121	111	100	92	
		F	17.9+32R	20.1+25R	23+20R	24.8+16R	27.5+13R	29+10R	31.5+8R	35.2+4R	38.6+1R	
	BP @ 12"	q	222	201	184	172	162	154	147	136	128	
		F	15.9+33R	18+27R	19.9+22R	21.6+19R	23.1+16R	24.6+13R	25.9+11R	28.3+8R	30.3+6R	
	TSW @ 24"	q	527	551	498	521	480	500	467	458	451	
		F	5+38R	5.1+33R	5.8+29R	5.7+25R	6.3+23R	6.1+21R	6.6+19R	6.8+16R	7+14R	
	TSW @ 12"	q	739	730	723	717	712	709	705	700	697	
		F	3.4+38R	3.8+33R	4.1+29R	4.3+26R	4.5+23R	4.6+21R	4.7+19R	4.9+16R	5+14R	
	21	BP @ 24"	q	224	204	179	168	152	146	134	121	111
			F	17.3+23R	19.3+19R	22+14R	23.7+11R	26.2+8R	27.7+6R	30+4R	33.5+1R	36.7-2R
BP @ 12"		q	267	241	222	207	195	185	177	164	155	
		F	15.4+25R	17.3+20R	19.1+16R	20.6+13R	22.1+11R	23.4+9R	24.7+7R	26.9+5R	28.9+3R	
TSW @ 24"		q	615	641	579	605	557	580	541	530	522	
		F	5+30R	5+26R	5.6+22R	5.5+20R	6+18R	5.9+16R	6.3+15R	6.5+13R	6.6+11R	
TSW @ 12"		q	866	854	845	838	832	828	823	817	812	
		F	3.5+30R	3.8+26R	4+23R	4.2+20R	4.3+18R	4.4+16R	4.5+15R	4.7+13R	4.8+11R	
20		BP @ 24"	q	261	239	209	197	177	171	156	141	130
			F	16.7+18R	18.6+14R	21.2+10R	22.8+8R	25.2+5R	26.5+4R	28.8+2R	32.1-1R	35.1-3R
	BP @ 12"	q	313	283	260	243	229	218	208	193	182	
		F	14.9+19R	16.7+15R	18.3+12R	19.8+10R	21.2+8R	22.5+6R	23.7+5R	25.8+3R	27.6+1R	
	TSW @ 24"	q	701	730	659	687	632	659	614	601	591	
		F	5+24R	4.9+21R	5.5+18R	5.4+16R	5.8+14R	5.7+13R	6+12R	6.2+10R	6.3+9R	
	TSW @ 12"	q	991	977	966	958	950	945	940	932	926	
		F	3.5+24R	3.7+21R	3.9+18R	4.1+16R	4.2+15R	4.3+13R	4.3+12R	4.5+10R	4.5+9R	
	19	BP @ 24"	q	351	321	281	265	239	230	211	191	176
			F	15.6+11R	17.3+8R	19.6+5R	21.1+3R	23.3+1R	24.5+0R	26.6-2R	29.6-4R	32.4-5R
BP @ 12"		q	421	381	351	328	309	294	281	261	246	
		F	13.9+12R	15.5+9R	17+7R	18.4+5R	19.6+4R	20.8+2R	21.8+1R	23.8+0R	25.5-1R	
TSW @ 24"		q	897	931	838	873	801	834	776	758	744	
		F	4.7+16R	4.6+14R	5.1+12R	5+11R	5.4+10R	5.2+9R	5.5+8R	5.7+7R	5.7+6R	
TSW @ 12"		q	1276	1256	1240	1227	1217	1208	1201	1190	1181	
		F	3.4+16R	3.5+14R	3.7+12R	3.8+11R	3.9+10R	3.9+9R	4+8R	4.1+7R	4.1+6R	
18		BP @ 24"	q	447	410	358	339	305	294	269	244	225
			F	14.7+6R	16.3+4R	18.4+2R	19.8+1R	21.8-1R	22.9-2R	24.9-3R	27.7-5R	30.3-6R
	BP @ 12"	q	539	488	450	420	396	377	361	335	316	
		F	13.1+7R	14.6+5R	15.9+4R	17.2+2R	18.3+1R	19.4+0R	20.4+0R	22.2-2R	23.8-3R	
	TSW @ 24"	q	1100	1139	1023	1064	975	1014	942	919	901	
		F	4.5+12R	4.4+10R	4.8+9R	4.7+8R	5+7R	4.8+6R	5.1+6R	5.2+5R	5.3+4R	
	TSW @ 12"	q	1572	1544	1522	1505	1491	1480	1470	1454	1443	
		F	3.2+12R	3.3+10R	3.4+9R	3.5+8R	3.6+7R	3.6+6R	3.7+6R	3.7+5R	3.8+4R	
	16	BP @ 24"	q	587	544	476	455	410	398	365	333	310
			F	13.1+2R	14.5+0R	16.4-1R	17.6-2R	19.4-3R	20.4-4R	22.1-5R	24.6-6R	27-7R
BP @ 12"		q	730	667	619	582	553	528	508	476	453	
		F	11.7+3R	13+1R	14.2+0R	15.3-1R	16.3-1R	17.3-2R	18.1-2R	19.7-3R	21.1-4R	
TSW @ 24"		q	1429	1485	1336	1392	1278	1331	1238	1210	1188	
		F	4+6R	3.9+6R	4.2+5R	4.1+4R	4.4+4R	4.2+4R	4.5+3R	4.5+3R	4.6+2R	
TSW @ 12"		q	2032	2000	1975	1955	1939	1926	1915	1897	1883	
		F	2.9+7R	3+6R	3+5R	3.1+4R	3.1+4R	3.1+4R	3.2+3R	3.2+3R	3.2+3R	

See footnotes on page 69.

Notes:

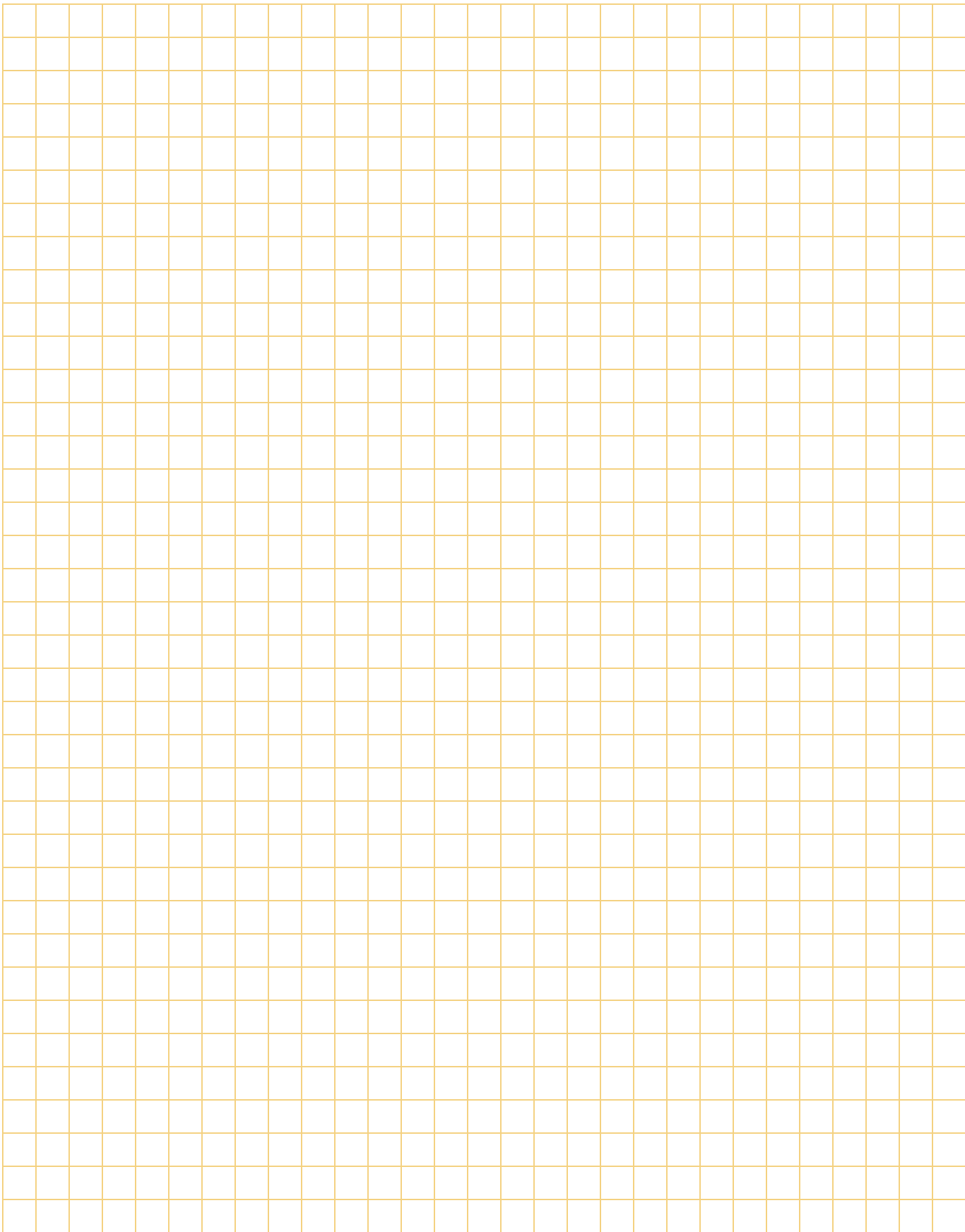

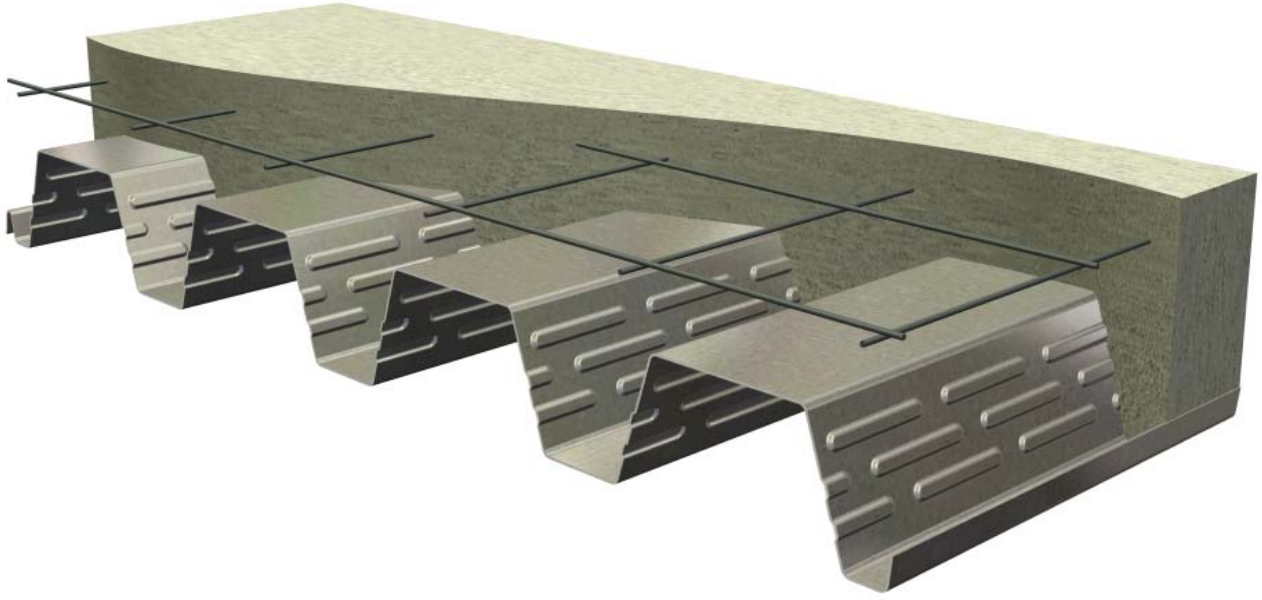

PLN3™ FORMLOK™ and N3 FORMLOK™

PLN3™ AND N3 FORMLOK™ CONTENTS

Section Properties	86
PLN3™ and N3 FORMLOK™ Tables	88-96
5 in. Total Slab Depth Normal Weight Concrete	88
5½ in. Total Slab Depth Normal Weight Concrete	89
6 in. Total Slab Depth Normal Weight Concrete	90
6½ in. Total Slab Depth Normal Weight Concrete	91
7½ in. Total Slab Depth Normal Weight Concrete	92
5 in. Total Slab Depth Light Weight Concrete	93
5½ in. Total Slab Depth Light Weight Concrete	94
6¼ in. Total Slab Depth Light Weight Concrete	95
7¼ in. Total Slab Depth Light Weight Concrete	96

PLN3™ or N3 FORMLOK™

- 3 in. Deep FORMLOK Deck
- Phosphatized/Painted or Galvanized
- PLN3 FORMLOK used with PunchLok II System
- N3 FORMLOK used with TSWs or BPs
- N3 FORMLOK-SS and N3 FORMLOK-NS used with Screws

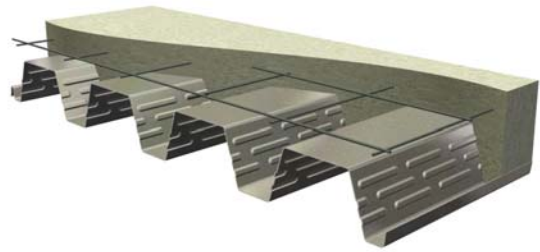

Dimensions

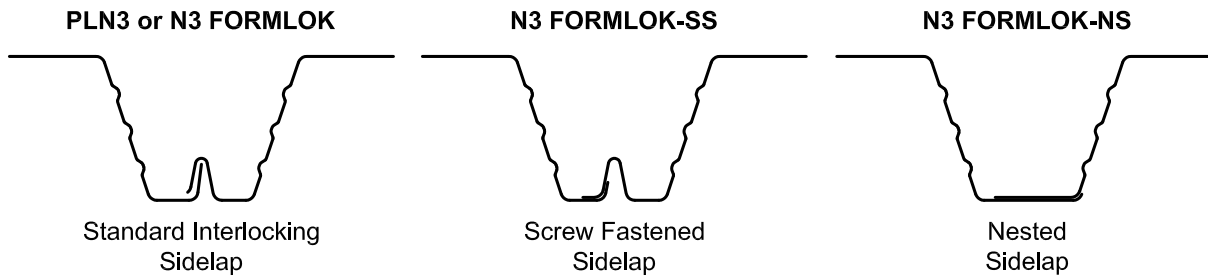
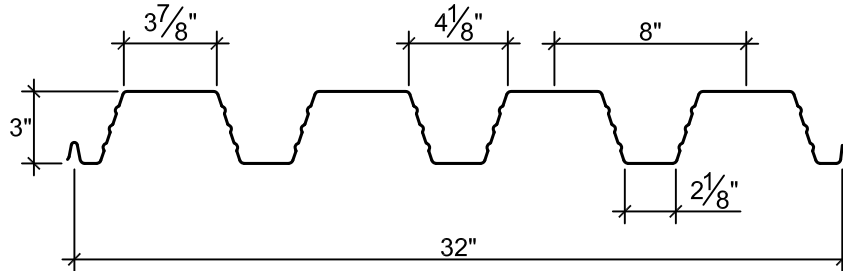

Deck Weight and Section Properties

Gage	Weight		I_d for Deflection		Moment		Allowable Reactions per ft of Width (lb) due to Web Crippling									
	Galv (psf)	Painted (psf)	Single Span (in. ⁴ /ft)	Multi Span (in. ⁴ /ft)	+ S_{eff} (in. ³ /ft)	- S_{eff} (in. ³ /ft)	One Flange Loading				Two Flange Loading					
							End Bearing Length		Interior Bearing Length		End Bearing Length		Interior Bearing Length			
							2"	3"	4"	4"	8"	2"	3"	4"	4"	8"
20	2.4	2.3	0.889	0.953	0.452	0.509	870	997	1105	1738	2154	871	971	1056	2066	2597
18	3.1	3.0	1.229	1.273	0.671	0.722	1481	1687	1860	2941	3682	1624	1797	1943	3574	4548
16	3.9	3.8	1.571	1.587	0.883	0.932	2240	2538	2789	4430	5497	2611	2873	3094	5458	6887

- Notes:**
1. Section properties are based on $F_y = 50,000$ psi.
 2. I_d is for deflection due to uniform loads.
 3. S_{eff} (+ or -) is the effective section modulus.
 4. Allowable (ASD) reactions are based on web crippling, per AISI S100 Section C3.4, where $\Omega_w = 1.70$ for end bearing and 1.75 for interior bearing. Nominal reactions may be determined by multiplying the table values by Ω_w . LRFd reactions may be determined by multiplying nominal reactions by $\phi_w = 0.9$ for end reactions and 0.85 for interior reactions.

Attachment Patterns to Supports

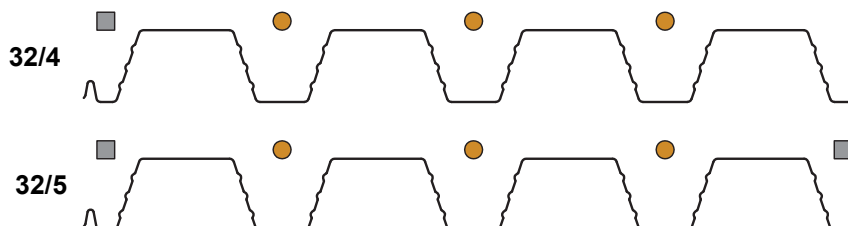

- Note:** ● indicates location of arc spot weld, power actuated fastener, or screw as indicated in the load tables.
 ■ indicates location of arc seam weld, power actuated fastener, or screw as indicated in the load tables.

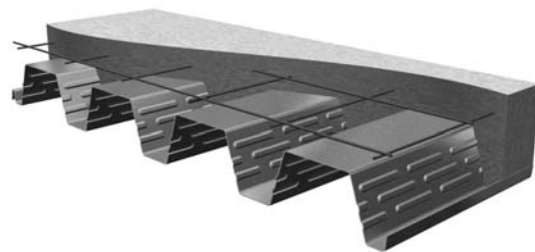

Footnotes for Maximum Unshored Clear Span, Allowable Superimposed Loads, and Allowable Diaphragm Shear Strength Tables

1. Shoring calculations are based on the following:
 - Deck supporting dead load of concrete plus 20 psf uniform construction load or 150 pound concentrated construction live load for flexure. 4 psf is added for normal weight concrete and 3 psf is added for light weight concrete to account for ponding due to deck deflection between support members.
 - Dead load deflection limited to $L/180$ of span length, not to exceed 3/4".
 - Minimum end and interior bearing of 2".
2. Concrete fill to have minimum 28-day compressive strength $f'_c = 3,000$ psi.
3. Total slab depth is nominal depth from top of concrete to bottom of steel deck.
4. Shoring is required at midspan for allowable superimposed loads in the shaded area to the right of the heavy line.
5. Nominal diaphragm shear strengths may be determined by multiplying the tabulated strengths by $\Omega = 3.0$. LRFD diaphragm shear strength may be determined by multiplying nominal diaphragm shear strength by $\phi = 0.55$.
6. PLN3 and N3 FORMLOK decks with structural concrete have a Flexibility Factor of $F < 1$.
7. To obtain allowable diaphragm shear strengths using mechanical fasteners, multiply the tabulated strengths by the appropriate adjustment factor, A_q listed in the following table.

Attachment Pattern	Adjustment Factor	Total Slab Depth (in.)									
		Normal Weight Concrete					Light Weight Concrete				
		5	5 1/2	6	6 1/2	7 1/2	5	5 1/2	6 1/4	7 1/4	
32/4	A_{q4}	0.78	0.85	0.82	0.73	0.61	0.67	0.73	0.80	0.85	
32/5	A_{q5}	0.71	0.77	0.82	0.85	0.73	0.61	0.66	0.73	0.80	

Notes:

- a. Mechanical fastener attachment patterns are to match the listed attachment patterns for welds.
- b. Applicable mechanical fasteners are limited to the following: Hilti Fasteners, Pneutek Fasteners and SDI Recognized #12 or #14 Screws produced by Buildex, Elco, Hilti or Simpson Strong-Tie. Comply with minimum and maximum substrate thickness requirements for applicable mechanical fasteners. Note that these adjustment factors are based on the most conservative value for all listed connectors.
- c. Nominal diaphragm shear strengths for mechanically fastened FORMLOK slabs may be determined by multiplying the adjusted tabulated strengths by $\Omega = 3.25$. LRFD diaphragm shear strengths for mechanically fastened FORMLOK slabs may be determined by multiplying the adjusted nominal strengths by $\phi = 0.50$.
- d. Consult fastener manufacturer for applicable fire-resistance assembly ratings where mechanical fasteners are required.

PLN3™ or N3 FORMLOK™

- 5 in. TOTAL SLAB DEPTH
- Normal Weight Concrete

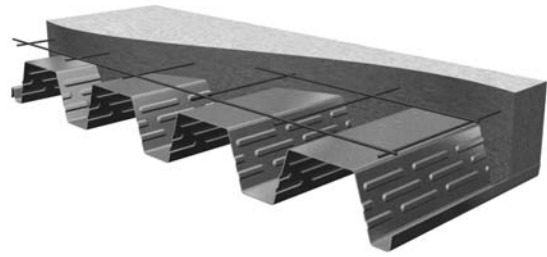

Maximum Unshored Clear Span (ft-in.)

Gage	Number of Deck Spans		
	1	2	3
20	11'-2"	12'-6"	12'-11"
18	12'-9"	14'-9"	15'-0"
16	13'-6"	16'-9"	15'-10"

Shoring is required for spans greater than those shown above. See Footnote 1 on page 87 for required bearing.

Concrete Properties

Density (pcf)	Uniform Weight (psf)	Uniform Volume (yd ³ /100 ft ²)	Compressive Strength, f' _c (psi)
145	38.3	0.979	3000

Notes:

1. Volumes and weights do not include allowance for deflection.
2. Weights are for concrete only and do not include weight of steel deck.
3. Total slab depth is nominal depth from top of concrete to bottom of steel deck.

Allowable Superimposed Loads (psf)

Deck Gage	Number of Deck Spans	Span (ft-in.)															
		8'-0"	8'-6"	9'-0"	9'-6"	10'-0"	10'-6"	11'-0"	11'-6"	12'-0"	12'-6"	13'-0"	13'-6"	14'-0"	15'-0"	16'-0"	
20	1	365	318	279	245	217	193	172	115	98	84	72	60	50	33	19	
	2	365	318	279	245	217	193	172	153	137	123	72	60	50	33	19	
	3	365	318	279	245	217	193	172	153	137	123	72	60	50	33	19	
18	1	400	400	371	328	292	260	233	209	189	170	115	100	87	65	47	
	2	400	400	371	328	292	260	233	209	189	170	154	139	126	65	47	
	3	400	400	371	328	292	260	233	209	189	170	154	139	126	104	47	
16	1	400	400	400	400	363	325	292	264	238	216	196	179	123	96	74	
	2	400	400	400	400	363	325	292	264	238	216	196	179	163	136	114	
	3	400	400	400	400	363	325	292	264	238	216	196	179	163	136	74	

See footnotes on page 87.

Shoring required in shaded areas to right of heavy line.

Allowable Diaphragm Shear Strengths, q (plf) and Flexibility Factors, F (in./lb. x 10⁶)

Attachment Pattern	Deck Gage	q	Span (ft-in.)															
			8'-0"	8'-6"	9'-0"	9'-6"	10'-0"	10'-6"	11'-0"	11'-6"	12'-0"	12'-6"	13'-0"	13'-6"	14'-0"	15'-0"	16'-0"	
32/4	20	q	1651	1633	1617	1603	1589	1578	1567	1557	1548	1540	1532	1525	1519	1507	1497	
	18	q	1703	1678	1657	1638	1620	1604	1590	1577	1565	1554	1544	1535	1526	1510	1497	
	16	q	1771	1740	1713	1689	1668	1648	1630	1614	1599	1585	1572	1561	1550	1530	1513	
32/5	20	q	1806	1776	1749	1725	1703	1683	1665	1649	1634	1620	1608	1596	1585	1565	1548	
	18	q	1933	1892	1856	1824	1795	1769	1745	1724	1704	1685	1668	1653	1638	1612	1589	
	16	q	2075	2024	1979	1939	1903	1870	1840	1813	1788	1765	1744	1724	1706	1673	1645	

See footnotes on page 87.

PLN3™ or N3 FORMLOK™

- 5½ in. TOTAL SLAB DEPTH
- Normal Weight Concrete

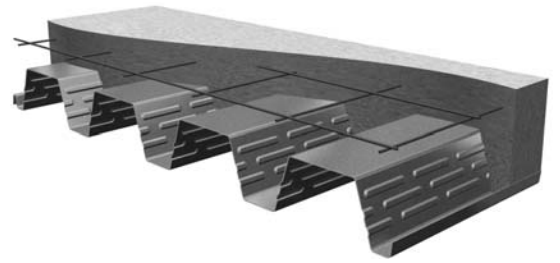

Maximum Unshored Clear Span (ft-in.)

Gage	Number of Deck Spans		
	1	2	3
20	10'-8"	11'-11"	12'-4"
18	12'-4"	14'-2"	14'-7"
16	13'-1"	16'-0"	15'-4"

Shoring is required for spans greater than those shown above. See Footnote 1 on page 87 for required bearing.

Concrete Properties

Density (pcf)	Uniform Weight (psf)	Uniform Volume (yd ³ /100 ft ²)	Compressive Strength, f _c (psi)
145	44.4	1.133	3000

Notes:

1. Volumes and weights do not include allowance for deflection.
2. Weights are for concrete only and do not include weight of steel deck.
3. Total slab depth is nominal depth from top of concrete to bottom of steel deck.

Allowable Superimposed Loads (psf)

Deck Gage	Number of Deck Spans	Span (ft-in.)															
		8'-0"	8'-6"	9'-0"	9'-6"	10'-0"	10'-6"	11'-0"	11'-6"	12'-0"	12'-6"	13'-0"	13'-6"	14'-0"	15'-0"	16'-0"	
20	1	400	378	331	292	259	230	161	139	120	103	88	75	63	43	26	
	2	400	378	331	292	259	230	205	183	120	103	88	75	63	43	26	
	3	400	378	331	292	259	230	205	183	164	103	88	75	63	43	26	
18	1	400	400	400	390	347	310	278	250	225	159	140	123	107	81	60	
	2	400	400	400	390	347	310	278	250	225	204	184	167	152	81	60	
	3	400	400	400	390	347	310	278	250	225	204	184	167	152	81	60	
16	1	400	400	400	400	400	387	348	314	284	258	234	168	150	118	92	
	2	400	400	400	400	400	387	348	314	284	258	234	213	195	163	137	
	3	400	400	400	400	400	387	348	314	284	258	234	213	195	163	92	

See footnotes on page 87.

Shoring required in shaded areas to right of heavy line.

Allowable Diaphragm Shear Strengths, q (plf) and Flexibility Factors, F (in./lb. x 10⁶)

Attachment Pattern	Deck Gage	Span (ft-in.)															
		8'-0"	8'-6"	9'-0"	9'-6"	10'-0"	10'-6"	11'-0"	11'-6"	12'-0"	12'-6"	13'-0"	13'-6"	14'-0"	15'-0"	16'-0"	
32/4	20	q	1890	1872	1856	1842	1829	1817	1806	1796	1787	1779	1771	1764	1758	1746	1736
	18	q	1942	1917	1896	1877	1859	1844	1829	1816	1804	1793	1783	1774	1765	1749	1736
	16	q	2010	1980	1953	1928	1907	1887	1869	1853	1838	1824	1811	1800	1789	1769	1752
32/5	20	q	2045	2015	1988	1964	1942	1922	1905	1888	1873	1860	1847	1835	1824	1804	1787
	18	q	2172	2131	2095	2063	2034	2008	1984	1963	1943	1924	1908	1892	1877	1851	1828
	16	q	2314	2263	2218	2178	2142	2109	2079	2052	2027	2004	1983	1963	1945	1913	1884

See footnotes on page 87.

PLN3™ or N3 FORMLOK™

- 6 in. TOTAL SLAB DEPTH
- Normal Weight Concrete

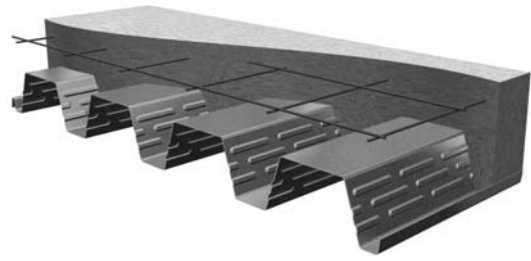

Maximum Unshored Clear Span (ft-in.)

Gage	Number of Deck Spans		
	1	2	3
20	10'-2"	11'-5"	11'-10"
18	12'-0"	13'-7"	14'-1"
16	12'-9"	15'-4"	14'-11"

Shoring is required for spans greater than those shown above. See Footnote 1 on page 87 for required bearing.

Concrete Properties

Density (pcf)	Uniform Weight (psf)	Uniform Volume (yd ³ /100 ft ²)	Compressive Strength, f' _c (psi)
145	50.4	1.288	3000

Notes:

1. Volumes and weights do not include allowance for deflection.
2. Weights are for concrete only and do not include weight of steel deck.
3. Total slab depth is nominal depth from top of concrete to bottom of steel deck.

Allowable Superimposed Loads (psf)

Deck Gage	Number of Deck Spans	Span (ft-in.)														
		8'-0"	8'-6"	9'-0"	9'-6"	10'-0"	10'-6"	11'-0"	11'-6"	12'-0"	12'-6"	13'-0"	13'-6"	14'-0"	15'-0"	16'-0"
20	1	400	400	388	342	303	221	192	166	144	125	107	92	78	54	35
	2	400	400	388	342	303	270	241	166	144	125	107	92	78	54	35
	3	400	400	388	342	303	270	241	215	144	125	107	92	78	54	35
18	1	400	400	400	400	400	364	326	294	265	190	168	148	130	99	74
	2	400	400	400	400	400	364	326	294	265	240	217	197	130	99	74
	3	400	400	400	400	400	364	326	294	265	240	217	197	179	99	74
16	1	400	400	400	400	400	400	400	368	334	303	225	201	179	142	112
	2	400	400	400	400	400	400	400	368	334	303	276	251	230	193	112
	3	400	400	400	400	400	400	400	368	334	303	276	251	230	142	112

See footnotes on page 87.

Shoring required in shaded areas to right of heavy line.

Allowable Diaphragm Shear Strengths, q (plf) and Flexibility Factors, F (in./lb. x 10⁶)

Attachment Pattern	Deck Gage	q	Span (ft-in.)														
			8'-0"	8'-6"	9'-0"	9'-6"	10'-0"	10'-6"	11'-0"	11'-6"	12'-0"	12'-6"	13'-0"	13'-6"	14'-0"	15'-0"	16'-0"
32/4	20	q	2130	2111	2095	2081	2068	2056	2045	2035	2026	2018	2010	2003	1997	1985	1975
	18	q	2181	2157	2135	2116	2098	2083	2068	2055	2043	2032	2022	2013	2004	1988	1975
	16	q	2249	2219	2192	2167	2146	2126	2108	2092	2077	2063	2051	2039	2028	2008	1991
32/5	20	q	2284	2254	2227	2203	2181	2161	2144	2127	2112	2099	2086	2074	2063	2044	2026
	18	q	2411	2370	2335	2302	2273	2247	2224	2202	2182	2164	2147	2131	2116	2090	2067
	16	q	2553	2502	2457	2417	2381	2348	2318	2291	2266	2243	2222	2203	2184	2152	2123

See footnotes on page 87.

PLN3™ or N3 FORMLOK™

- 6½ in. TOTAL SLAB DEPTH
- Normal Weight Concrete
- 1 Hour Fire Rating

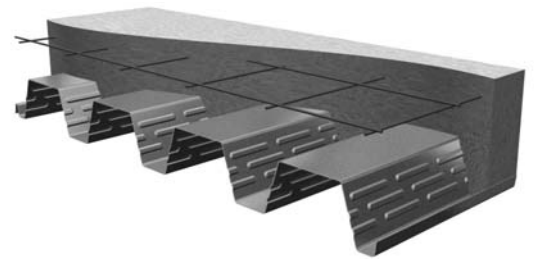

Maximum Unshored Clear Span (ft-in.)

Gage	Number of Deck Spans		
	1	2	3
20	9'-9"	11'-0"	11'-5"
18	11'-8"	13'-1"	13'-6"
16	12'-5"	14'-10"	14'-7"

Shoring is required for spans greater than those shown above. See Footnote 1 on page 87 for required bearing.

Concrete Properties

Density (pcf)	Uniform Weight (psf)	Uniform Volume (yd ³ /100 ft ²)	Compressive Strength, f _c (psi)
145	56.5	1.442	3000

Notes:

1. Volumes and weights do not include allowance for deflection.
2. Weights are for concrete only and do not include weight of steel deck.
3. Total slab depth is nominal depth from top of concrete to bottom of steel deck.

Allowable Superimposed Loads (psf)

Deck Gage	Number of Deck Spans	Span (ft-in.)															
		8'-0"	8'-6"	9'-0"	9'-6"	10'-0"	10'-6"	11'-0"	11'-6"	12'-0"	12'-6"	13'-0"	13'-6"	14'-0"	15'-0"	16'-0"	
20	1	400	400	400	395	296	258	224	195	170	147	127	110	94	66	44	
	2	400	400	400	395	350	312	279	195	170	147	127	110	94	66	44	
	3	400	400	400	395	350	312	279	195	170	147	127	110	94	66	44	
18	1	400	400	400	400	400	400	377	340	252	223	197	174	154	119	90	
	2	400	400	400	400	400	400	377	340	307	278	252	174	154	119	90	
	3	400	400	400	400	400	400	377	340	307	278	252	229	154	119	90	
16	1	400	400	400	400	400	400	400	400	386	295	264	236	211	169	134	
	2	400	400	400	400	400	400	400	400	386	351	320	292	267	169	134	
	3	400	400	400	400	400	400	400	400	386	351	320	292	267	169	134	

See footnotes on page 87.

Shoring required in shaded areas to right of heavy line.

Allowable Diaphragm Shear Strengths, q (plf) and Flexibility Factors, F (in./lb. x 10⁶)

Attachment Pattern	Deck Gage	q	Span (ft-in.)															
			8'-0"	8'-6"	9'-0"	9'-6"	10'-0"	10'-6"	11'-0"	11'-6"	12'-0"	12'-6"	13'-0"	13'-6"	14'-0"	15'-0"	16'-0"	
32/4	20	q	2369	2350	2334	2320	2307	2295	2284	2274	2265	2257	2250	2243	2236	2224	2214	
	18	q	2420	2396	2374	2355	2337	2322	2307	2294	2282	2271	2261	2252	2243	2228	2214	
	16	q	2488	2458	2431	2407	2385	2365	2347	2331	2316	2302	2290	2278	2267	2247	2230	
32/5	20	q	2523	2493	2466	2442	2420	2401	2383	2366	2351	2338	2325	2313	2302	2283	2265	
	18	q	2650	2610	2574	2542	2513	2486	2463	2441	2421	2403	2386	2370	2356	2329	2306	
	16	q	2792	2741	2696	2656	2620	2587	2557	2530	2505	2482	2461	2442	2423	2391	2362	

See footnotes on page 87.

PLN3™ or N3 FORMLOK™

- 7½ in. TOTAL SLAB DEPTH
- Normal Weight Concrete
- 2 Hour Fire Rating

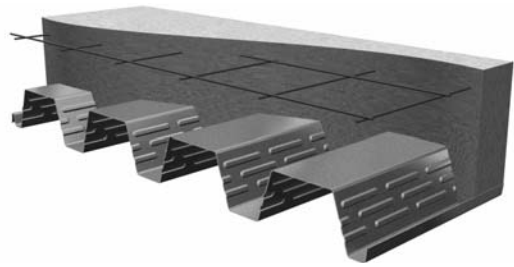

Maximum Unshored Clear Span (ft-in.)

Gage	Number of Deck Spans		
	1	2	3
20	9'-1"	10'-4"	10'-8"
18	11'-2"	12'-3"	12'-8"
16	11'-11"	13'-10"	13'-11"

Shoring is required for spans greater than those shown above. See Footnote 1 on page 87 for required bearing.

Concrete Properties

Density (pcf)	Uniform Weight (psf)	Uniform Volume (yd ³ /100 ft ²)	Compressive Strength, f' _c (psi)
145	68.5	1.751	3000

Notes:

1. Volumes and weights do not include allowance for deflection.
2. Weights are for concrete only and do not include weight of steel deck.
3. Total slab depth is nominal depth from top of concrete to bottom of steel deck.

Allowable Superimposed Loads (psf)

Deck Gage	Number of Deck Spans	Span (ft-in.)														
		8'-0"	8'-6"	9'-0"	9'-6"	10'-0"	10'-6"	11'-0"	11'-6"	12'-0"	12'-6"	13'-0"	13'-6"	14'-0"	15'-0"	16'-0"
20	1	400	400	400	400	385	336	294	257	224	196	170	148	128	93	65
	2	400	400	400	400	400	336	294	257	224	196	170	148	128	93	65
	3	400	400	400	400	400	400	294	257	224	196	170	148	128	93	65
18	1	400	400	400	400	400	400	400	372	330	293	260	231	205	161	124
	2	400	400	400	400	400	400	400	400	395	293	260	231	205	161	124
	3	400	400	400	400	400	400	400	400	400	395	358	260	231	205	161
16	1	400	400	400	400	400	400	400	400	400	387	347	312	280	225	181
	2	400	400	400	400	400	400	400	400	400	400	400	377	280	225	181
	3	400	400	400	400	400	400	400	400	400	400	400	400	377	280	225

See footnotes on page 87.

Shoring required in shaded areas to right of heavy line.

Allowable Diaphragm Shear Strengths, q (plf) and Flexibility Factors, F (in./lb. x 10⁶)

Attachment Pattern	Deck Gage	q	Span (ft-in.)														
			8'-0"	8'-6"	9'-0"	9'-6"	10'-0"	10'-6"	11'-0"	11'-6"	12'-0"	12'-6"	13'-0"	13'-6"	14'-0"	15'-0"	16'-0"
32/4	20	q	2847	2829	2812	2798	2785	2773	2762	2753	2744	2735	2728	2721	2714	2702	2692
	18	q	2898	2874	2852	2833	2816	2800	2786	2773	2761	2750	2740	2730	2721	2706	2692
	16	q	2966	2936	2909	2885	2863	2843	2826	2809	2794	2781	2768	2756	2745	2725	2708
32/5	20	q	3002	2971	2944	2920	2898	2879	2861	2845	2830	2816	2803	2791	2780	2761	2744
	18	q	3128	3088	3052	3020	2991	2965	2941	2919	2899	2881	2864	2848	2834	2808	2785
	16	q	3270	3219	3175	3134	3098	3065	3036	3008	2983	2961	2939	2920	2902	2869	2840

See footnotes on page 87.

PLN3™ or N3 FORMLOK™

- 5 in. TOTAL SLAB DEPTH
- Light Weight Concrete

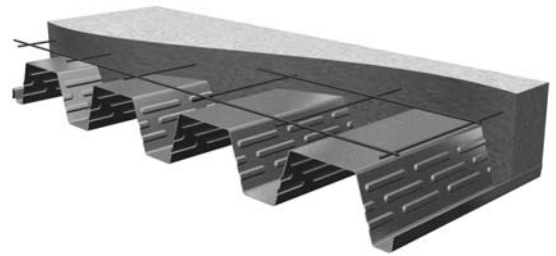

Maximum Unshored Clear Span (ft-in.)

Gage	Number of Deck Spans		
	1	2	3
20	12'-4"	13'-7"	14'-11"
18	13'-7"	16'-1"	16'-0"
16	14'-4"	17'-11"	16'-10"

Shoring is required for spans greater than those shown above. See Footnote 1 on page 87 for required bearing.

Concrete Properties

Density (pcf)	Uniform Weight (psf)	Uniform Volume (yd ³ /100 ft ²)	Compressive Strength, f' _c (psi)
110	29.1	0.979	3000

Notes:

1. Volumes and weights do not include allowance for deflection.
2. Weights are for concrete only and do not include weight of steel deck.
3. Total slab depth is nominal depth from top of concrete to bottom of steel deck.

Allowable Superimposed Loads (psf)

Deck Gage	Number of Deck Spans	Span (ft-in.)															
		8'-0"	8'-6"	9'-0"	9'-6"	10'-0"	10'-6"	11'-0"	11'-6"	12'-0"	12'-6"	13'-0"	13'-6"	14'-0"	15'-0"	16'-0"	
20	1	352	308	271	239	213	190	170	121	106	93	81	70	60	44	31	
	2	352	308	271	239	213	190	170	152	137	123	81	70	60	44	31	
	3	352	308	271	239	213	190	170	152	137	123	81	70	60	44	31	
18	1	400	400	356	316	282	252	226	204	184	167	120	107	95	74	57	
	2	400	400	356	316	282	252	226	204	184	167	152	138	126	74	57	
	3	400	400	356	316	282	252	226	204	184	167	152	138	126	105	57	
16	1	400	400	400	389	347	312	281	254	230	209	190	174	127	102	81	
	2	400	400	400	389	347	312	281	254	230	209	190	174	159	134	113	
	3	400	400	400	389	347	312	281	254	230	209	190	174	159	134	81	

See footnotes on page 87.

Shoring required in shaded areas to right of heavy line.

Allowable Diaphragm Shear Strengths, q (plf) and Flexibility Factors, F (in./lb. x 10⁶)

Attachment Pattern	Deck Gage	Span (ft-in.)															
		8'-0"	8'-6"	9'-0"	9'-6"	10'-0"	10'-6"	11'-0"	11'-6"	12'-0"	12'-6"	13'-0"	13'-6"	14'-0"	15'-0"	16'-0"	
32/4	20	q	1327	1309	1293	1278	1265	1253	1243	1233	1224	1216	1208	1201	1194	1182	1172
	18	q	1378	1354	1332	1313	1296	1280	1266	1253	1241	1230	1220	1210	1202	1186	1172
	16	q	1446	1416	1389	1365	1343	1324	1306	1289	1274	1261	1248	1236	1225	1206	1188
32/5	20	q	1482	1451	1424	1400	1379	1359	1341	1325	1310	1296	1283	1272	1261	1241	1224
	18	q	1608	1568	1532	1500	1471	1445	1421	1399	1379	1361	1344	1328	1314	1288	1265
	16	q	1750	1700	1655	1614	1578	1545	1516	1489	1464	1441	1420	1400	1382	1349	1320

See footnotes on page 87.

PLN3™ or N3 FORMLOK™

- 5½ in. TOTAL SLAB DEPTH
- Light Weight Concrete
- 1 Hour Fire Rating

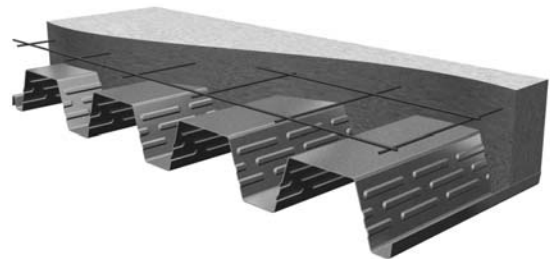

Maximum Unshored Clear Span (ft-in.)

Gage	Number of Deck Spans		
	1	2	3
20	11'-9"	13'-1"	13'-6"
18	13'-2"	15'-6"	15'-6"
16	13'-11"	17'-5"	16'-4"

Shoring is required for spans greater than those shown above. See Footnote 1 on page 87 for required bearing.

Concrete Properties

Density (pcf)	Uniform Weight (psf)	Uniform Volume (yd ³ /100 ft ²)	Compressive Strength, f' _c (psi)
110	33.7	1.133	3000

Notes:

1. Volumes and weights do not include allowance for deflection.
2. Weights are for concrete only and do not include weight of steel deck.
3. Total slab depth is nominal depth from top of concrete to bottom of steel deck.

Allowable Superimposed Loads (psf)

Deck Gage	Number of Deck Spans	Span (ft-in.)															
		8'-0"	8'-6"	9'-0"	9'-6"	10'-0"	10'-6"	11'-0"	11'-6"	12'-0"	12'-6"	13'-0"	13'-6"	14'-0"	15'-0"	16'-0"	
20	1	400	366	322	285	253	226	168	147	129	113	99	86	75	56	40	
	2	400	366	322	285	253	226	202	182	129	113	99	86	75	56	40	
	3	400	366	322	285	253	226	202	182	164	113	99	86	75	56	40	
18	1	400	400	400	376	335	300	270	243	220	164	146	130	116	91	71	
	2	400	400	400	376	335	300	270	243	220	200	181	165	151	91	71	
	3	400	400	400	376	335	300	270	243	220	200	181	165	151	91	71	
16	1	400	400	400	400	400	370	334	302	274	249	227	172	154	125	100	
	2	400	400	400	400	400	370	334	302	274	249	227	208	190	160	136	
	3	400	400	400	400	400	370	334	302	274	249	227	208	190	160	100	

See footnotes on page 87.

Shoring required in shaded areas to right of heavy line.

Allowable Diaphragm Shear Strengths, q (plf) and Flexibility Factors, F (in./lb. x 10⁶)

Attachment Pattern	Deck Gage	q	Span (ft-in.)															
			8'-0"	8'-6"	9'-0"	9'-6"	10'-0"	10'-6"	11'-0"	11'-6"	12'-0"	12'-6"	13'-0"	13'-6"	14'-0"	15'-0"	16'-0"	
32/4	20	q	1485	1467	1451	1436	1423	1411	1401	1391	1382	1373	1366	1359	1352	1340	1330	
	18	q	1536	1512	1490	1471	1454	1438	1424	1411	1399	1388	1378	1368	1359	1344	1330	
	16	q	1604	1574	1547	1523	1501	1481	1464	1447	1432	1419	1406	1394	1383	1364	1346	
32/5	20	q	1640	1609	1582	1558	1537	1517	1499	1483	1468	1454	1441	1429	1419	1399	1382	
	18	q	1766	1726	1690	1658	1629	1603	1579	1557	1537	1519	1502	1486	1472	1446	1423	
	16	q	1908	1858	1813	1772	1736	1703	1674	1647	1622	1599	1578	1558	1540	1507	1478	

See footnotes on page 87.

PLN3™ or N3 FORMLOK™

- 6¼ in. TOTAL SLAB DEPTH
- Light Weight Concrete
- 2 Hour Fire Rating

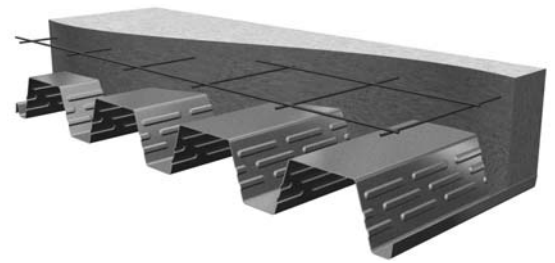

Maximum Unshored Clear Span (ft-in.)

Gage	Number of Deck Spans		
	1	2	3
20	11'-1"	12'-4"	12'-10"
18	12'-8"	14'-8"	14'-11"
16	13'-5"	16'-7"	15'-9"

Shoring is required for spans greater than those shown above. See Footnote 1 on page 87 for required bearing.

Concrete Properties

Density (pcf)	Uniform Weight (psf)	Uniform Volume (yd ³ /100 ft ²)	Compressive Strength, f' _c (psi)
110	40.5	1.365	3000

Notes:

1. Volumes and weights do not include allowance for deflection.
2. Weights are for concrete only and do not include weight of steel deck.
3. Total slab depth is nominal depth from top of concrete to bottom of steel deck.

Allowable Superimposed Loads (psf)

Deck Gage	Number of Deck Spans	Span (ft-in.)															
		8'-0"	8'-6"	9'-0"	9'-6"	10'-0"	10'-6"	11'-0"	11'-6"	12'-0"	12'-6"	13'-0"	13'-6"	14'-0"	15'-0"	16'-0"	
20	1	400	400	400	360	320	246	216	190	168	148	130	114	100	76	56	
	2	400	400	400	360	320	286	257	190	168	148	130	114	100	76	56	
	3	400	400	400	360	320	286	257	231	168	148	130	114	100	76	56	
18	1	400	400	400	400	400	379	341	308	279	213	190	170	151	120	95	
	2	400	400	400	400	400	379	341	308	279	254	231	211	151	120	95	
	3	400	400	400	400	400	379	341	308	279	254	231	211	193	120	95	
16	1	400	400	400	400	400	400	400	382	347	316	247	222	201	163	132	
	2	400	400	400	400	400	400	400	382	347	316	289	264	242	205	132	
	3	400	400	400	400	400	400	400	382	347	316	289	264	242	163	132	

See footnotes on page 87.

Shoring required in shaded areas to right of heavy line.

Allowable Diaphragm Shear Strengths, q (plf) and Flexibility Factors, F (in./lb. x 10⁶)

Attachment Pattern	Deck Gage	Span (ft-in.)															
		8'-0"	8'-6"	9'-0"	9'-6"	10'-0"	10'-6"	11'-0"	11'-6"	12'-0"	12'-6"	13'-0"	13'-6"	14'-0"	15'-0"	16'-0"	
32/4	20	q	1722	1704	1688	1673	1660	1648	1637	1628	1619	1610	1603	1596	1589	1577	1567
	18	q	1773	1749	1727	1708	1691	1675	1661	1648	1636	1625	1615	1605	1596	1581	1567
	16	q	1841	1811	1784	1760	1738	1718	1701	1684	1669	1656	1643	1631	1620	1601	1583
32/5	20	q	1877	1846	1819	1795	1773	1754	1736	1720	1705	1691	1678	1666	1656	1636	1619
	18	q	2003	1963	1927	1895	1866	1840	1816	1794	1774	1756	1739	1723	1709	1683	1660
	16	q	2145	2095	2050	2009	1973	1940	1911	1883	1859	1836	1814	1795	1777	1744	1715

See footnotes on page 87.

PLN3™ or N3 FORMLOK™

- 7¼ in. TOTAL SLAB DEPTH
- Light Weight Concrete
- 3 Hour Fire Rating

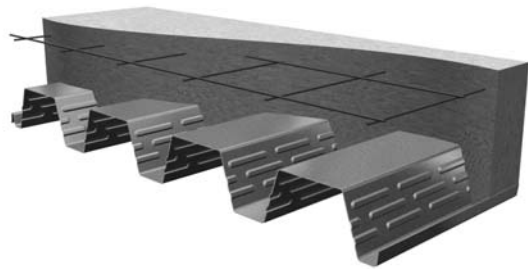

Maximum Unshored Clear Span (ft-in.)

Gage	Number of Deck Spans		
	1	2	3
20	10'-4"	11'-7"	12'-0"
18	12'-1"	13'-8"	14'-3"
16	12'-10"	15'-7"	15'-0"

Shoring is required for spans greater than those shown above. See Footnote 1 on page 87 for required bearing.

Concrete Properties

Density (pcf)	Uniform Weight (psf)	Uniform Volume (yd ³ /100 ft ²)	Compressive Strength, f' _c (psi)
110	49.7	1.673	3000

Notes:

1. Volumes and weights do not include allowance for deflection.
2. Weights are for concrete only and do not include weight of steel deck.
3. Total slab depth is nominal depth from top of concrete to bottom of steel deck.

Allowable Superimposed Loads (psf)

Deck Gage	Number of Deck Spans	Span (ft-in.)															
		8'-0"	8'-6"	9'-0"	9'-6"	10'-0"	10'-6"	11'-0"	11'-6"	12'-0"	12'-6"	13'-0"	13'-6"	14'-0"	15'-0"	16'-0"	
20	1	400	400	400	400	369	325	287	253	224	198	176	155	137	106	80	
	2	400	400	400	400	400	373	335	253	224	198	176	155	137	106	80	
	3	400	400	400	400	400	373	335	253	224	198	176	155	137	106	80	
18	1	400	400	400	400	400	400	400	400	317	284	254	228	205	165	132	
	2	400	400	400	400	400	400	400	400	366	333	303	228	205	165	132	
	3	400	400	400	400	400	400	400	400	366	333	303	277	205	165	132	
16	1	400	400	400	400	400	400	400	400	400	365	329	298	269	221	181	
	2	400	400	400	400	400	400	400	400	400	400	379	347	319	221	181	
	3	400	400	400	400	400	400	400	400	400	400	379	347	319	221	181	

See footnotes on page 87.

Shoring required in shaded areas to right of heavy line.

Allowable Diaphragm Shear Strengths, q (plf) and Flexibility Factors, F (in./lb. x 10⁶)

Attachment Pattern	Deck Gage	q	Span (ft-in.)															
			8'-0"	8'-6"	9'-0"	9'-6"	10'-0"	10'-6"	11'-0"	11'-6"	12'-0"	12'-6"	13'-0"	13'-6"	14'-0"	15'-0"	16'-0"	
32/4	20	q	2038	2020	2003	1989	1976	1964	1953	1944	1935	1926	1919	1912	1905	1893	1883	
	18	q	2089	2065	2043	2024	2007	1991	1977	1964	1952	1941	1931	1921	1912	1897	1883	
	16	q	2157	2127	2100	2076	2054	2034	2017	2000	1985	1972	1959	1947	1936	1917	1899	
32/5	20	q	2193	2162	2135	2111	2089	2070	2052	2036	2021	2007	1994	1982	1971	1952	1935	
	18	q	2319	2279	2243	2211	2182	2156	2132	2110	2090	2072	2055	2039	2025	1999	1976	
	16	q	2461	2410	2366	2325	2289	2256	2227	2199	2175	2152	2130	2111	2093	2060	2031	

See footnotes on page 87.

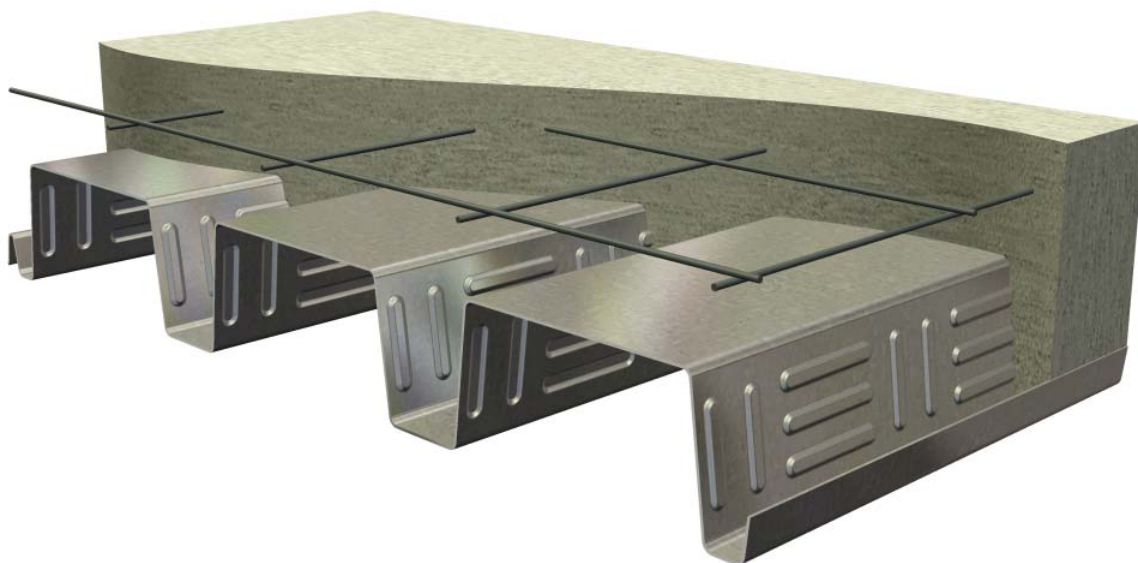

PLN™ FORMLOK™ and N FORMLOK™

PLN™ AND N FORMLOK™ CONTENTS

Section Properties	98
PLN™ and N FORMLOK™ Tables	100-108
5 in. Total Slab Depth Normal Weight Concrete	100
5½ in. Total Slab Depth Normal Weight Concrete.....	101
6 in. Total Slab Depth Normal Weight Concrete	102
6½ in. Total Slab Depth Normal Weight Concrete.....	103
7½ in. Total Slab Depth Normal Weight Concrete.....	104
5 in. Total Slab Depth Light Weight Concrete	105
5½ in. Total Slab Depth Light Weight Concrete.....	106
6¼ in. Total Slab Depth Light Weight Concrete.....	107
7¼ in. Total Slab Depth Light Weight Concrete.....	108

PLN™ or N FORMLOK™

- 3 in. Deep FORMLOK Deck
- Phosphatized/Painted or Galvanized
- PLN FORMLOK used with PunchLok II System
- N FORMLOK used with TSWs or BPs
- N FORMLOK-SS used with Screws



Dimensions

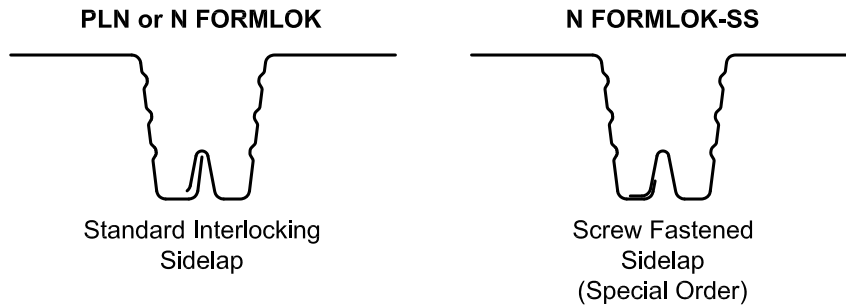
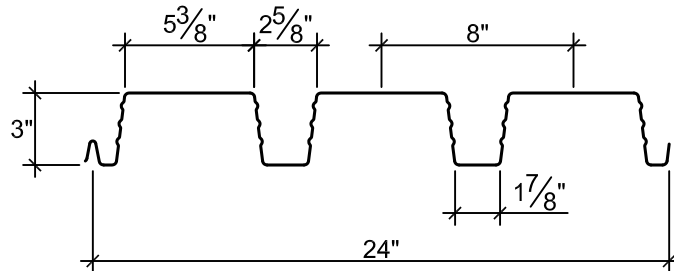

Deck Weight and Section Properties

Gage	Weight		I_d for Deflection		Moment		Allowable Reactions per ft of Width (lb) due to Web Crippling									
	Galv (psf)	Painted (psf)	Single Span (in.4/ft)	Multi Span (in.4/ft)	$+S_{eff}$ (in.3/ft)	$-S_{eff}$ (in.3/ft)	One Flange Loading					Two Flange Loading				
							End Bearing Length		Interior Bearing Length			End Bearing Length		Interior Bearing Length		
							2"	3"	4"	4"	8"	2"	3"	4"	4"	8"
22	2.2	2.1	0.733	0.857	0.344	0.429	654	753	836	1300	1518	620	694	757	1530	1804
20	2.6	2.5	0.908	1.032	0.443	0.531	921	1056	1169	1823	2259	931	1038	1128	2182	2742
18	3.5	3.4	1.267	1.369	0.652	0.735	1566	1783	1967	3085	3860	1730	1915	2070	3771	4794
16	4.2	4.1	1.642	1.706	0.837	0.914	2367	2681	2946	4648	5758	2776	3055	3290	5756	7249

- Notes:**
1. Section properties are based on $F_y = 50,000$ psi.
 2. I_d is for deflection due to uniform loads.
 3. S_{eff} (+ or -) is the effective section modulus.
 4. Allowable (ASD) reactions are based on web crippling, per AISI S100 Section C3.4, where $\Omega_w = 1.70$ for end bearing and 1.75 for interior bearing. Nominal reactions may be determined by multiplying the table values by Ω_w . LRFD reactions may be determined by multiplying nominal reactions by $\phi_w = 0.9$ for end reactions and 0.85 for interior reactions.

Attachment Patterns to Supports



- Note:** ● indicates location of arc spot weld, power actuated fastener, or screw as indicated in the load tables.
 ■ indicates location of arc seam weld, power actuated fastener, or screw as indicated in the load tables.



Footnotes for Maximum Unshored Clear Span, Allowable Superimposed Loads, and Allowable Diaphragm Shear Strength Tables

1. Shoring calculations are based on the following:
 - Deck supporting dead load of concrete plus 20 psf uniform construction load or 150 pound concentrated construction live load for flexure. 4 psf is added for normal weight concrete and 3 psf is added for light weight concrete to account for ponding due to deck deflection between support members.
 - Dead load deflection limited to L/180 of span length, not to exceed 3/4".
 - Minimum end and interior bearing of 2".
2. Concrete fill to have minimum 28-day compressive strength $f'_c = 3,000$ psi.
3. Total slab depth is nominal depth from top of concrete to bottom of steel deck.
4. Shoring is required at midspan for allowable superimposed loads in the shaded area to the right of the heavy line.
5. Nominal diaphragm shear strengths may be determined by multiplying the tabulated strengths by $\Omega = 3.0$. LRFD diaphragm shear strength may be determined by multiplying nominal diaphragm shear strength by $\phi = 0.55$.
6. To obtain allowable diaphragm shear strengths using mechanical fasteners, multiply the tabulated strengths by the appropriate adjustment factor, A_q listed in the following table.

Attachment Pattern	Adjustment Factor	Total Slab Depth (in.)									
		Normal Weight Concrete					Light Weight Concrete				
		5	5 1/2	6	6 1/2	7 1/2	5	5 1/2	6 1/4	7 1/4	
24/4	A_{q4}	0.74	0.80	0.79	0.71	0.60	0.64	0.69	0.76	0.83	

Notes:

- a. Mechanical fastener attachment patterns are to match the listed attachment patterns for welds.
- b. Applicable mechanical fasteners are limited to the following: Hilti Fasteners, Pneutek Fasteners and SDI Recognized #12 or #14 Screws produced by Buildex, Elco, Hilti or Simpson Strong-Tie. Comply with minimum and maximum substrate thickness requirements for applicable mechanical fasteners. Note that these adjustment factors are based on the most conservative value for all listed connectors.
- c. Nominal diaphragm shear strengths for mechanically fastened FORMLOK slabs may be determined by multiplying the adjusted tabulated strengths by $\Omega = 3.25$. LRFD diaphragm shear strengths for mechanically fastened FORMLOK slabs may be determined by multiplying the adjusted nominal strengths by $\phi = 0.50$.
- d. Consult fastener manufacturer for applicable fire-resistance assembly ratings where mechanical fasteners are required.

PLN™ or N FORMLOK™

- 5 in. TOTAL SLAB DEPTH
- Normal Weight Concrete



Maximum Unshored Clear Span (ft-in.)

Gage	Number of Deck Spans		
	1	2	3
22	9'-9"	11'-5"	11'-6"
20	11'-5"	13'-2"	13'-5"
18	13'-1"	15'-4"	15'-8"
16	13'-11"	17'-0"	16'-5"

Shoring is required for spans greater than those shown above. See Footnote 1 on page 99 for required bearing.

Concrete Properties

Density (pcf)	Uniform Weight (psf)	Uniform Volume (yd ³ /100 ft ²)	Compressive Strength, f' _c (psi)
145	34.4	0.878	3000

Notes:

1. Volumes and weights do not include allowance for deflection.
2. Weights are for concrete only and do not include weight of steel deck.
3. Total slab depth is nominal depth from top of concrete to bottom of steel deck.

Allowable Superimposed Loads (psf)

Deck Gage	Number of Deck Spans	Span (ft-in.)															
		8'-0"	8'-6"	9'-0"	9'-6"	10'-0"	10'-6"	11'-0"	11'-6"	12'-0"	12'-6"	13'-0"	13'-6"	14'-0"	15'-0"	16'-0"	
22	1	241	218	198	181	131	118	107	97	88	80	72	66	60	50	41	
	2	241	218	198	181	166	153	142	97	88	80	72	66	60	50	41	
	3	241	218	198	181	166	153	142	132	88	80	72	66	60	50	41	
20	1	255	231	210	192	176	162	150	104	95	86	78	71	65	54	45	
	2	255	231	210	192	176	162	150	139	130	121	114	71	65	54	45	
	3	255	231	210	192	176	162	150	139	130	121	114	71	65	54	45	
18	1	257	232	211	193	177	163	151	140	131	122	114	72	65	54	45	
	2	257	232	211	193	177	163	151	140	131	122	114	107	101	90	45	
	3	257	232	211	193	177	163	151	140	131	122	114	107	101	90	45	
16	1	259	234	213	195	179	165	152	142	132	123	115	108	65	54	45	
	2	259	234	213	195	179	165	152	142	132	123	115	108	102	91	82	
	3	259	234	213	195	179	165	152	142	132	123	115	108	102	91	82	

See footnotes on page 99.

Shoring required in shaded areas to right of heavy line.

Allowable Diaphragm Shear Strengths, q (plf) and Flexibility Factors, F (in./lb. x 10⁶)

Attachment Pattern	Deck Gage	Span (ft-in.)															
		8'-0"	8'-6"	9'-0"	9'-6"	10'-0"	10'-6"	11'-0"	11'-6"	12'-0"	12'-6"	13'-0"	13'-6"	14'-0"	15'-0"	16'-0"	
	22	q	1699	1678	1658	1641	1625	1611	1599	1587	1576	1566	1557	1549	1541	1527	1515
		F	1.10	1.11	1.13	1.14	1.15	1.16	1.17	1.18	1.19	1.19	1.20	1.21	1.21	1.22	1.23
24/4	20	q	1741	1715	1692	1671	1652	1635	1620	1606	1593	1581	1570	1560	1551	1534	1519
		F	0.98	0.99	1.01	1.02	1.03	1.04	1.05	1.06	1.07	1.08	1.09	1.09	1.10	1.11	1.12
	18	q	1842	1808	1777	1749	1724	1702	1681	1663	1646	1630	1615	1602	1589	1567	1547
		F	0.80	0.82	0.83	0.84	0.86	0.87	0.88	0.89	0.90	0.91	0.91	0.92	0.93	0.94	0.96
	16	q	1959	1916	1877	1843	1812	1783	1758	1734	1713	1693	1675	1658	1643	1615	1590
		F	0.67	0.69	0.70	0.72	0.73	0.74	0.75	0.76	0.77	0.78	0.79	0.80	0.80	0.82	0.83

See footnotes on page 99.

PLN™ or N FORMLOK™

- 5½ in. TOTAL SLAB DEPTH
- Normal Weight Concrete



Maximum Unshored Clear Span (ft-in.)

Gage	Number of Deck Spans		
	1	2	3
22	9'-4"	10'-10"	10'-11"
20	10'-10"	12'-6"	12'-9"
18	12'-8"	14'-8"	15'-1"
16	13'-5"	16'-3"	15'-11"

Shoring is required for spans greater than those shown above. See Footnote 1 on page 99 for required bearing.

Concrete Properties

Density (pcf)	Uniform Weight (psf)	Uniform Volume (yd ³ /100 ft ²)	Compressive Strength, f _c (psi)
145	40.4	1.032	3000

Notes:

1. Volumes and weights do not include allowance for deflection.
2. Weights are for concrete only and do not include weight of steel deck.
3. Total slab depth is nominal depth from top of concrete to bottom of steel deck.

Allowable Superimposed Loads (psf)

Deck Gage	Number of Deck Spans	Span (ft-in.)															
		8'-0"	8'-6"	9'-0"	9'-6"	10'-0"	10'-6"	11'-0"	11'-6"	12'-0"	12'-6"	13'-0"	13'-6"	14'-0"	15'-0"	16'-0"	
22	1	264	238	217	158	142	128	115	104	94	85	77	70	64	52	43	
	2	264	238	217	198	182	168	115	104	94	85	77	70	64	52	43	
	3	264	238	217	198	182	168	115	104	94	85	77	70	64	52	43	
20	1	278	252	229	209	192	177	123	112	101	92	84	76	69	57	47	
	2	278	252	229	209	192	177	164	152	142	132	84	76	69	57	47	
	3	278	252	229	209	192	177	164	152	142	132	84	76	69	57	47	
18	1	279	252	229	209	192	177	164	152	142	132	83	75	69	57	47	
	2	279	252	229	209	192	177	164	152	142	132	124	117	110	57	47	
	3	279	252	229	209	192	177	164	152	142	132	124	117	110	98	47	
16	1	279	253	230	210	193	178	164	153	142	133	124	75	68	56	46	
	2	279	253	230	210	193	178	164	153	142	133	124	117	110	98	88	
	3	279	253	230	210	193	178	164	153	142	133	124	117	110	98	46	

See footnotes on page 99.

Shoring required in shaded areas to right of heavy line.

Allowable Diaphragm Shear Strengths, q (plf) and Flexibility Factors, F (in./lb. x 10⁶)

Attachment Pattern	Deck Gage	Span (ft-in.)															
		8'-0"	8'-6"	9'-0"	9'-6"	10'-0"	10'-6"	11'-0"	11'-6"	12'-0"	12'-6"	13'-0"	13'-6"	14'-0"	15'-0"	16'-0"	
	22	q	1938	1917	1897	1880	1865	1850	1838	1826	1815	1805	1796	1788	1780	1766	1754
		F	0.96	0.97	0.98	0.99	1.00	1.01	1.02	1.02	1.03	1.03	1.04	1.04	1.05	1.06	1.07
24/4	20	q	1980	1954	1931	1910	1891	1874	1859	1845	1832	1820	1809	1799	1790	1773	1758
		F	0.86	0.87	0.88	0.89	0.90	0.91	0.92	0.92	0.93	0.94	0.94	0.95	0.95	0.96	0.97
	18	q	2081	2047	2016	1988	1963	1941	1920	1902	1885	1869	1854	1841	1828	1806	1786
		F	0.71	0.72	0.73	0.74	0.75	0.76	0.77	0.78	0.78	0.79	0.80	0.80	0.81	0.82	0.83
	16	q	2198	2155	2116	2082	2051	2022	1997	1974	1952	1932	1914	1897	1882	1854	1829
		F	0.60	0.61	0.62	0.63	0.64	0.65	0.66	0.67	0.68	0.68	0.69	0.70	0.70	0.71	0.72

See footnotes on page 99.

PLN™ or N FORMLOK™

- 6 in. TOTAL SLAB DEPTH
- Normal Weight Concrete



Maximum Unshored Clear Span (ft-in.)

Gage	Number of Deck Spans		
	1	2	3
22	8'-11"	10'-4"	10'-5"
20	10'-4"	12'-0"	12'-2"
18	12'-4"	14'-1"	14'-7"
16	13'-1"	15'-7"	15'-5"

Shoring is required for spans greater than those shown above. See Footnote 1 on page 99 for required bearing.

Concrete Properties

Density (pcf)	Uniform Weight (psf)	Uniform Volume (yd ³ /100 ft ²)	Compressive Strength, f' _c (psi)
145	46.4	1.186	3000

Notes:

1. Volumes and weights do not include allowance for deflection.
2. Weights are for concrete only and do not include weight of steel deck.
3. Total slab depth is nominal depth from top of concrete to bottom of steel deck.

Allowable Superimposed Loads (psf)

Deck Gage	Number of Deck Spans	Span (ft-in.)															
		8'-0"	8'-6"	9'-0"	9'-6"	10'-0"	10'-6"	11'-0"	11'-6"	12'-0"	12'-6"	13'-0"	13'-6"	14'-0"	15'-0"	16'-0"	
22	1	289	261	192	172	154	138	125	113	102	92	83	76	68	56	46	
	2	289	261	238	217	199	138	125	113	102	92	83	76	68	56	46	
	3	289	261	238	217	199	138	125	113	102	92	83	76	68	56	46	
20	1	304	275	250	229	210	148	133	121	109	99	90	82	74	61	50	
	2	304	275	250	229	210	193	179	166	155	99	90	82	74	61	50	
	3	304	275	250	229	210	193	179	166	155	99	90	82	74	61	50	
18	1	304	274	250	228	209	193	179	166	154	98	89	81	73	60	49	
	2	304	274	250	228	209	193	179	166	154	144	135	127	119	60	49	
	3	304	274	250	228	209	193	179	166	154	144	135	127	119	60	49	
16	1	303	274	249	228	209	193	178	166	154	144	135	80	72	59	48	
	2	303	274	249	228	209	193	178	166	154	144	135	127	119	106	48	
	3	303	274	249	228	209	193	178	166	154	144	135	127	119	106	48	

See footnotes on page 99.

Shoring required in shaded areas to right of heavy line.

Allowable Diaphragm Shear Strengths, q (plf) and Flexibility Factors, F (in./lb. x 10⁶)

Attachment Pattern	Deck Gage	Span (ft-in.)															
		8'-0"	8'-6"	9'-0"	9'-6"	10'-0"	10'-6"	11'-0"	11'-6"	12'-0"	12'-6"	13'-0"	13'-6"	14'-0"	15'-0"	16'-0"	
24/4	22	q	2178	2156	2136	2119	2104	2090	2077	2065	2054	2045	2035	2027	2019	2005	1993
		F	0.86	0.87	0.87	0.88	0.89	0.89	0.90	0.90	0.91	0.91	0.92	0.92	0.93	0.93	0.94
	20	q	2219	2193	2170	2149	2130	2113	2098	2084	2071	2059	2048	2038	2029	2012	1997
		F	0.77	0.78	0.79	0.79	0.80	0.81	0.81	0.82	0.82	0.83	0.83	0.84	0.84	0.85	0.85
	18	q	2321	2286	2255	2227	2202	2180	2159	2141	2124	2108	2093	2080	2067	2045	2025
		F	0.64	0.65	0.66	0.66	0.67	0.68	0.68	0.69	0.70	0.70	0.71	0.71	0.71	0.72	0.73
16	q	2437	2394	2355	2321	2290	2262	2236	2213	2191	2172	2153	2136	2121	2093	2068	
	F	0.54	0.55	0.56	0.57	0.58	0.58	0.59	0.60	0.60	0.61	0.61	0.62	0.62	0.63	0.64	

See footnotes on page 99.

PLN™ or N FORMLOK™

- 6½ in. TOTAL SLAB DEPTH
- Normal Weight Concrete
- 1 Hour Fire Rating



Maximum Unshored Clear Span (ft.-in.)

Gage	Number of Deck Spans		
	1	2	3
22	8'-6"	9'-11"	10'-0"
20	9'-11"	11'-6"	11'-7"
18	12'-0"	13'-6"	14'-0"
16	12'-9"	15'-0"	15'-1"

Shoring is required for spans greater than those shown above. See Footnote 1 on page 99 for required bearing.

Concrete Properties

Density (pcf)	Uniform Weight (psf)	Uniform Volume (yd ³ /100 ft ²)	Compressive Strength, f _c (psi)
145	52.5	1.341	3000

Notes:

1. Volumes and weights do not include allowance for deflection.
2. Weights are for concrete only and do not include weight of steel deck.
3. Total slab depth is nominal depth from top of concrete to bottom of steel deck.

Allowable Superimposed Loads (psf)

Deck Gage	Number of Deck Spans	Span (ft.-in.)														
		8'-0"	8'-6"	9'-0"	9'-6"	10'-0"	10'-6"	11'-0"	11'-6"	12'-0"	12'-6"	13'-0"	13'-6"	14'-0"	15'-0"	16'-0"
22	1	316	286	209	187	167	150	135	122	110	100	90	82	74	60	49
	2	316	286	260	237	167	150	135	122	110	100	90	82	74	60	49
	3	316	286	260	237	218	150	135	122	110	100	90	82	74	60	49
20	1	332	301	273	250	178	161	145	131	118	107	97	88	80	66	54
	2	332	301	273	250	229	211	196	182	118	107	97	88	80	66	54
	3	332	301	273	250	229	211	196	182	118	107	97	88	80	66	54
18	1	331	299	272	248	228	210	195	181	168	106	96	87	79	65	53
	2	331	299	272	248	228	210	195	181	168	157	147	138	79	65	53
	3	331	299	272	248	228	210	195	181	168	157	147	138	130	65	53
16	1	329	298	271	247	227	209	194	180	168	157	94	85	77	63	52
	2	329	298	271	247	227	209	194	180	168	157	147	138	130	116	52
	3	329	298	271	247	227	209	194	180	168	157	147	138	130	116	52

See footnotes on page 99.

Shoring required in shaded areas to right of heavy line.

Allowable Diaphragm Shear Strengths, q (plf) and Flexibility Factors, F (in./lb. x 10⁶)

Attachment Pattern	Deck Gage	Span (ft.-in.)															
		8'-0"	8'-6"	9'-0"	9'-6"	10'-0"	10'-6"	11'-0"	11'-6"	12'-0"	12'-6"	13'-0"	13'-6"	14'-0"	15'-0"	16'-0"	
	22	q	2417	2395	2376	2358	2343	2329	2316	2304	2293	2284	2275	2266	2258	2244	2232
	F	0.77	0.78	0.79	0.79	0.80	0.80	0.81	0.81	0.81	0.82	0.82	0.82	0.82	0.83	0.83	0.84
24/4	20	q	2458	2432	2409	2388	2369	2352	2337	2323	2310	2298	2288	2277	2268	2251	2236
	F	0.69	0.70	0.71	0.71	0.72	0.72	0.73	0.73	0.74	0.74	0.75	0.75	0.75	0.76	0.76	
	18	q	2560	2525	2494	2466	2442	2419	2399	2380	2363	2347	2332	2319	2307	2284	2264
	F	0.58	0.59	0.59	0.60	0.61	0.61	0.62	0.62	0.63	0.63	0.63	0.64	0.64	0.65	0.65	
	16	q	2677	2633	2594	2560	2529	2501	2475	2452	2430	2411	2392	2376	2360	2332	2307
	F	0.49	0.50	0.51	0.52	0.52	0.53	0.53	0.54	0.54	0.54	0.55	0.55	0.56	0.56	0.57	0.57

See footnotes on page 99.

PLN™ or N FORMLOK™

- 7½ in. TOTAL SLAB DEPTH
- Normal Weight Concrete
- 2 Hour Fire Rating

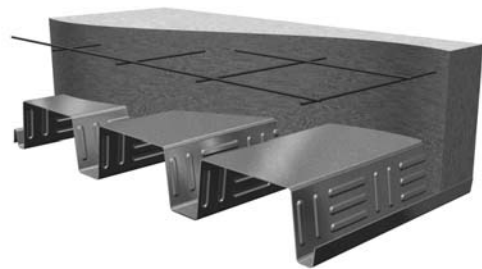

Maximum Unshored Clear Span (ft-in.)

Gage	Number of Deck Spans		
	1	2	3
22	7'-11"	9'-2"	9'-3"
20	9'-2"	10'-8"	10'-9"
18	11'-5"	12'-7"	13'-0"
16	12'-2"	14'-0"	14'-4"

Shoring is required for spans greater than those shown above. See Footnote 1 on page 99 for required bearing.

Concrete Properties

Density (pcf)	Uniform Weight (psf)	Uniform Volume (yd ³ /100 ft ²)	Compressive Strength, f' _c (psi)
145	64.6	1.649	3000

Notes:

1. Volumes and weights do not include allowance for deflection.
2. Weights are for concrete only and do not include weight of steel deck.
3. Total slab depth is nominal depth from top of concrete to bottom of steel deck.

Allowable Superimposed Loads (psf)

Deck Gage	Number of Deck Spans	Span (ft-in.)															
		8'-0"	8'-6"	9'-0"	9'-6"	10'-0"	10'-6"	11'-0"	11'-6"	12'-0"	12'-6"	13'-0"	13'-6"	14'-0"	15'-0"	16'-0"	
22	1	313	277	246	220	197	177	159	143	129	117	105	95	86	70	57	
	2	373	338	307	220	197	177	159	143	129	117	105	95	86	70	57	
	3	373	338	307	220	197	177	159	143	129	117	105	95	86	70	57	
20	1	392	355	322	233	209	188	170	153	138	125	113	103	93	76	62	
	2	392	355	322	295	270	249	170	153	138	125	113	103	93	76	62	
	3	392	355	322	295	270	249	170	153	138	125	113	103	93	76	62	
18	1	389	352	320	292	268	247	229	151	136	123	111	101	91	75	61	
	2	389	352	320	292	268	247	229	212	198	185	111	101	91	75	61	
	3	389	352	320	292	268	247	229	212	198	185	173	101	91	75	61	
16	1	386	349	317	290	266	246	227	211	197	121	109	99	89	73	59	
	2	386	349	317	290	266	246	227	211	197	184	172	162	152	73	59	
	3	386	349	317	290	266	246	227	211	197	184	172	162	152	73	59	

See footnotes on page 99.

Shoring required in shaded areas to right of heavy line.

Allowable Diaphragm Shear Strengths, q (plf) and Flexibility Factors, F (in./lb. x 10⁶)

Attachment Pattern	Deck Gage	Span (ft-in.)															
		8'-0"	8'-6"	9'-0"	9'-6"	10'-0"	10'-6"	11'-0"	11'-6"	12'-0"	12'-6"	13'-0"	13'-6"	14'-0"	15'-0"	16'-0"	
24/4	22	q	2895	2873	2854	2836	2821	2807	2794	2782	2772	2762	2753	2744	2736	2722	2710
		F	0.65	0.65	0.65	0.66	0.66	0.67	0.67	0.67	0.67	0.68	0.68	0.68	0.68	0.69	0.69
	20	q	2936	2910	2887	2866	2848	2831	2815	2801	2788	2777	2766	2756	2746	2729	2715
		F	0.58	0.59	0.59	0.59	0.60	0.60	0.61	0.61	0.61	0.61	0.62	0.62	0.62	0.62	0.63
	18	q	3038	3003	2972	2945	2920	2897	2877	2858	2841	2825	2811	2797	2785	2762	2743
		F	0.49	0.49	0.50	0.50	0.51	0.51	0.51	0.52	0.52	0.52	0.53	0.53	0.53	0.53	0.54
16	q	3155	3111	3073	3038	3007	2979	2953	2930	2908	2889	2871	2854	2838	2810	2785	
	F	0.42	0.42	0.43	0.43	0.44	0.44	0.45	0.45	0.45	0.46	0.46	0.46	0.47	0.47	0.47	

See footnotes on page 99.

PLN™ or N FORMLOK™

- 5 in. TOTAL SLAB DEPTH
- Light Weight Concrete



Maximum Unshored Clear Span (ft-in.)

Gage	Number of Deck Spans		
	1	2	3
22	10'-9"	12'-7"	12'-8"
20	12'-7"	14'-3"	14'-9"
18	13'-11"	16'-8"	16'-8"
16	14'-10"	18'-5"	17'-6"

Shoring is required for spans greater than those shown above. See Footnote 1 on page 99 for required bearing.

Concrete Properties

Density (pcf)	Uniform Weight (psf)	Uniform Volume (yd ³ /100 ft ²)	Compressive Strength, f' _c (psi)
110	26.1	0.878	3000

Notes:

1. Volumes and weights do not include allowance for deflection.
2. Weights are for concrete only and do not include weight of steel deck.
3. Total slab depth is nominal depth from top of concrete to bottom of steel deck.

Allowable Superimposed Loads (psf)

Deck Gage	Number of Deck Spans	Span (ft-in.)															
		8'-0"	8'-6"	9'-0"	9'-6"	10'-0"	10'-6"	11'-0"	11'-6"	12'-0"	12'-6"	13'-0"	13'-6"	14'-0"	15'-0"	16'-0"	
22	1	241	218	198	181	166	153	115	105	96	88	80	74	68	58	49	
	2	241	218	198	181	166	153	142	132	123	109	80	74	68	58	49	
	3	241	218	198	181	166	153	142	132	123	109	80	74	68	58	49	
20	1	255	231	210	192	176	162	150	139	130	118	86	79	73	62	53	
	2	255	231	210	192	176	162	150	139	130	118	105	94	84	62	53	
	3	255	231	210	192	176	162	150	139	130	118	105	94	84	62	53	
18	1	257	232	211	193	177	163	151	140	131	122	114	107	73	62	53	
	2	257	232	211	193	177	163	151	140	131	122	114	107	96	78	64	
	3	257	232	211	193	177	163	151	140	131	122	114	107	96	78	64	
16	1	259	234	213	195	179	165	152	142	132	123	115	108	102	62	53	
	2	259	234	213	195	179	165	152	142	132	123	115	108	102	87	72	
	3	259	234	213	195	179	165	152	142	132	123	115	108	102	87	72	

See footnotes on page 99.

Shoring required in shaded areas to right of heavy line.

Allowable Diaphragm Shear Strengths, q (plf) and Flexibility Factors, F (in./lb. x 10⁶)

Attachment Pattern	Deck Gage	Span (ft-in.)															
		8'-0"	8'-6"	9'-0"	9'-6"	10'-0"	10'-6"	11'-0"	11'-6"	12'-0"	12'-6"	13'-0"	13'-6"	14'-0"	15'-0"	16'-0"	
	22	q	1375	1353	1334	1317	1301	1287	1274	1262	1252	1242	1233	1224	1217	1203	1190
		F	1.36	1.38	1.40	1.42	1.44	1.45	1.47	1.48	1.49	1.50	1.52	1.53	1.54	1.55	1.57
	20	q	1416	1390	1367	1346	1328	1311	1295	1281	1269	1257	1246	1236	1226	1209	1195
		F	1.20	1.23	1.25	1.27	1.28	1.30	1.32	1.33	1.34	1.36	1.37	1.38	1.39	1.41	1.43
24/4	18	q	1518	1483	1452	1425	1400	1377	1357	1338	1321	1305	1291	1277	1265	1242	1223
		F	0.97	1.00	1.02	1.04	1.06	1.07	1.09	1.10	1.12	1.13	1.14	1.16	1.17	1.19	1.21
	16	q	1635	1591	1553	1518	1487	1459	1433	1410	1389	1369	1351	1334	1318	1290	1265
		F	0.81	0.83	0.85	0.87	0.89	0.91	0.92	0.94	0.95	0.96	0.98	0.99	1.00	1.02	1.04

See footnotes on page 99.

PLN™ or N FORMLOK™

- 5½ in. TOTAL SLAB DEPTH
- Light Weight Concrete
- 1 Hour Fire Rating



Maximum Unshored Clear Span (ft-in.)

Gage	Number of Deck Spans		
	1	2	3
22	10'-3"	11'-11"	12'-1"
20	12'-0"	13'-8"	14'-1"
18	13'-6"	16'-0"	16'-1"
16	14'-4"	17'-9"	16'-11"

Shoring is required for spans greater than those shown above. See Footnote 1 on page 99 for required bearing.

Concrete Properties

Density (pcf)	Uniform Weight (psf)	Uniform Volume (yd ³ /100 ft ²)	Compressive Strength, f' _c (psi)
110	30.7	1.032	3000

Notes:

1. Volumes and weights do not include allowance for deflection.
2. Weights are for concrete only and do not include weight of steel deck.
3. Total slab depth is nominal depth from top of concrete to bottom of steel deck.

Allowable Superimposed Loads (psf)

Deck Gage	Number of Deck Spans	Span (ft-in.)															
		8'-0"	8'-6"	9'-0"	9'-6"	10'-0"	10'-6"	11'-0"	11'-6"	12'-0"	12'-6"	13'-0"	13'-6"	14'-0"	15'-0"	16'-0"	
22	1	264	238	217	198	182	137	124	113	103	95	87	79	73	62	52	
	2	264	238	217	198	182	168	155	144	103	95	87	79	73	62	52	
	3	264	238	217	198	182	168	155	144	134	95	87	79	73	62	52	
20	1	278	252	229	209	192	177	164	152	142	101	93	85	78	66	57	
	2	278	252	229	209	192	177	164	152	142	132	124	116	78	66	57	
	3	278	252	229	209	192	177	164	152	142	132	124	116	110	66	57	
18	1	279	252	229	209	192	177	164	152	142	132	124	117	78	66	56	
	2	279	252	229	209	192	177	164	152	142	132	124	117	110	98	84	
	3	279	252	229	209	192	177	164	152	142	132	124	117	110	98	84	
16	1	279	253	230	210	193	178	164	153	142	133	124	117	110	65	55	
	2	279	253	230	210	193	178	164	153	142	133	124	117	110	98	88	
	3	279	253	230	210	193	178	164	153	142	133	124	117	110	98	88	

See footnotes on page 99.

Shoring required in shaded areas to right of heavy line.

Allowable Diaphragm Shear Strengths, q (plf) and Flexibility Factors, F (in./lb. x 10⁶)

Attachment Pattern	Deck Gage	Span (ft-in.)															
		8'-0"	8'-6"	9'-0"	9'-6"	10'-0"	10'-6"	11'-0"	11'-6"	12'-0"	12'-6"	13'-0"	13'-6"	14'-0"	15'-0"	16'-0"	
24/4	22	q	1533	1511	1492	1475	1459	1445	1432	1420	1410	1400	1391	1382	1375	1361	1348
		F	1.22	1.24	1.25	1.27	1.28	1.29	1.30	1.32	1.33	1.33	1.34	1.35	1.36	1.37	1.39
	20	q	1574	1548	1525	1504	1486	1469	1453	1439	1427	1415	1404	1394	1384	1367	1353
		F	1.08	1.10	1.12	1.13	1.15	1.16	1.17	1.18	1.20	1.21	1.21	1.22	1.23	1.25	1.26
	18	q	1676	1641	1610	1583	1558	1535	1515	1496	1479	1463	1449	1435	1423	1400	1381
		F	0.88	0.90	0.92	0.93	0.95	0.96	0.98	0.99	1.00	1.01	1.02	1.03	1.04	1.06	1.07
16	q	1793	1749	1711	1676	1645	1617	1591	1568	1547	1527	1509	1492	1476	1448	1423	
	F	0.74	0.76	0.77	0.79	0.80	0.82	0.83	0.84	0.85	0.87	0.88	0.89	0.89	0.91	0.93	

See footnotes on page 99.

PLN™ or N FORMLOK™

- 6¼ in. TOTAL SLAB DEPTH
- Light Weight Concrete
- 2 Hour Fire Rating



Maximum Unshored Clear Span (ft-in.)

Gage	Number of Deck Spans		
	1	2	3
22	9'-7"	11'-2"	11'-4"
20	11'-3"	12'-11"	13'-2"
18	12'-11"	15'-1"	15'-5"
16	13'-9"	16'-9"	16'-3"

Shoring is required for spans greater than those shown above. See Footnote 1 on page 99 for required bearing.

Concrete Properties

Density (pcf)	Uniform Weight (psf)	Uniform Volume (yd ³ /100 ft ²)	Compressive Strength, f' _c (psi)
110	37.5	1.264	3000

Notes:

1. Volumes and weights do not include allowance for deflection.
2. Weights are for concrete only and do not include weight of steel deck.
3. Total slab depth is nominal depth from top of concrete to bottom of steel deck.

Allowable Superimposed Loads (psf)

Deck Gage	Number of Deck Spans	Span (ft-in.)															
		8'-0"	8'-6"	9'-0"	9'-6"	10'-0"	10'-6"	11'-0"	11'-6"	12'-0"	12'-6"	13'-0"	13'-6"	14'-0"	15'-0"	16'-0"	
22	1	302	273	248	227	172	155	141	128	117	107	98	90	82	69	59	
	2	302	273	248	227	208	192	178	128	117	107	98	90	82	69	59	
	3	302	273	248	227	208	192	178	128	117	107	98	90	82	69	59	
20	1	318	288	262	239	219	202	187	137	125	114	105	96	88	75	63	
	2	318	288	262	239	219	202	187	174	162	151	105	96	88	75	63	
	3	318	288	262	239	219	202	187	174	162	151	142	96	88	75	63	
18	1	317	287	260	238	219	201	186	173	161	151	103	95	87	73	62	
	2	317	287	260	238	219	201	186	173	161	151	141	133	125	111	62	
	3	317	287	260	238	219	201	186	173	161	151	141	133	125	111	62	
16	1	316	286	260	237	218	201	186	173	161	150	141	132	86	72	61	
	2	316	286	260	237	218	201	186	173	161	150	141	132	124	111	100	
	3	316	286	260	237	218	201	186	173	161	150	141	132	124	111	100	

See footnotes on page 99.

Shoring required in shaded areas to right of heavy line.

Allowable Diaphragm Shear Strengths, q (plf) and Flexibility Factors, F (in./lb. x 10⁶)

Attachment Pattern	Deck Gage	Span (ft-in.)															
		8'-0"	8'-6"	9'-0"	9'-6"	10'-0"	10'-6"	11'-0"	11'-6"	12'-0"	12'-6"	13'-0"	13'-6"	14'-0"	15'-0"	16'-0"	
	22	q	1770	1748	1729	1712	1696	1682	1669	1657	1647	1637	1628	1619	1612	1597	1585
		F	1.06	1.07	1.08	1.09	1.10	1.11	1.12	1.13	1.13	1.14	1.15	1.15	1.16	1.17	1.18
24/4	20	q	1811	1785	1762	1741	1723	1706	1690	1676	1663	1652	1641	1631	1621	1604	1590
		F	0.94	0.95	0.97	0.98	0.99	1.00	1.01	1.02	1.02	1.03	1.04	1.05	1.05	1.06	1.07
	18	q	1913	1878	1847	1820	1795	1772	1752	1733	1716	1700	1686	1672	1660	1637	1618
		F	0.77	0.79	0.80	0.81	0.82	0.83	0.84	0.85	0.86	0.87	0.88	0.88	0.89	0.90	0.91
	16	q	2030	1986	1948	1913	1882	1854	1828	1805	1784	1764	1746	1729	1713	1685	1660
		F	0.65	0.67	0.68	0.69	0.70	0.71	0.72	0.73	0.74	0.75	0.76	0.76	0.77	0.78	0.80

See footnotes on page 99.

PLN™ or N FORMLOK™

- 7¼ in. TOTAL SLAB DEPTH
- Light Weight Concrete
- 3 Hour Fire Rating

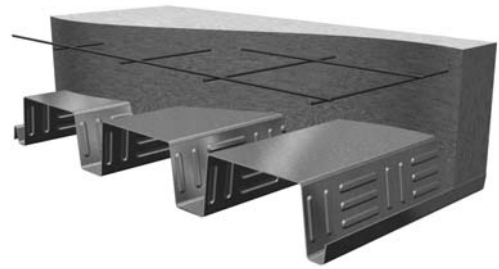

Maximum Unshored Clear Span (ft-in.)

Gage	Number of Deck Spans		
	1	2	3
22	8'-11"	10'-5"	10'-6"
20	10'-5"	12'-1"	12'-3"
18	12'-4"	14'-2"	14'-7"
16	13'-1"	15'-8"	15'-6"

Shoring is required for spans greater than those shown above. See Footnote 1 on page 99 for required bearing.

Concrete Properties

Density (pcf)	Uniform Weight (psf)	Uniform Volume (yd ³ /100 ft ²)	Compressive Strength, f' _c (psi)
110	46.7	1.572	3000

Notes:

1. Volumes and weights do not include allowance for deflection.
2. Weights are for concrete only and do not include weight of steel deck.
3. Total slab depth is nominal depth from top of concrete to bottom of steel deck.

Allowable Superimposed Loads (psf)

Deck Gage	Number of Deck Spans	Span (ft-in.)															
		8'-0"	8'-6"	9'-0"	9'-6"	10'-0"	10'-6"	11'-0"	11'-6"	12'-0"	12'-6"	13'-0"	13'-6"	14'-0"	15'-0"	16'-0"	
22	1	359	324	250	225	203	183	166	151	138	126	115	105	97	81	68	
	2	359	324	295	269	247	183	166	151	138	126	115	105	97	81	68	
	3	359	324	295	269	247	228	166	151	138	126	115	105	97	81	68	
20	1	377	341	310	283	260	195	177	161	147	134	123	113	103	87	74	
	2	377	341	310	283	260	240	222	206	192	134	123	113	103	87	74	
	3	377	341	310	283	260	240	222	206	192	134	123	113	103	87	74	
18	1	374	338	307	281	258	238	220	204	190	132	121	111	102	86	72	
	2	374	338	307	281	258	238	220	204	190	178	167	156	147	86	72	
	3	374	338	307	281	258	238	220	204	190	178	167	156	147	86	72	
16	1	372	336	305	279	256	236	219	203	189	177	165	109	100	84	71	
	2	372	336	305	279	256	236	219	203	189	177	165	155	146	130	71	
	3	372	336	305	279	256	236	219	203	189	177	165	155	146	130	71	

See footnotes on page 99.

Shoring required in shaded areas to right of heavy line.

Allowable Diaphragm Shear Strengths, q (plf) and Flexibility Factors, F (in./lb. x 10⁶)

Attachment Pattern	Deck Gage	Span (ft-in.)															
		8'-0"	8'-6"	9'-0"	9'-6"	10'-0"	10'-6"	11'-0"	11'-6"	12'-0"	12'-6"	13'-0"	13'-6"	14'-0"	15'-0"	16'-0"	
24/4	22	q	2086	2064	2045	2027	2012	1998	1985	1973	1963	1953	1944	1935	1927	1913	1901
		F	0.90	0.91	0.91	0.92	0.93	0.94	0.94	0.95	0.95	0.96	0.96	0.97	0.97	0.98	0.98
	20	q	2127	2101	2078	2057	2039	2022	2006	1992	1979	1968	1957	1947	1937	1920	1906
		F	0.80	0.81	0.82	0.83	0.84	0.84	0.85	0.86	0.86	0.87	0.87	0.88	0.88	0.89	0.89
	18	q	2229	2194	2163	2136	2111	2088	2068	2049	2032	2016	2002	1988	1976	1953	1934
		F	0.66	0.67	0.68	0.69	0.70	0.71	0.71	0.72	0.73	0.73	0.74	0.74	0.75	0.76	0.76
	16	q	2346	2302	2264	2229	2198	2170	2144	2121	2100	2080	2062	2045	2029	2001	1976
		F	0.56	0.57	0.58	0.59	0.60	0.61	0.62	0.62	0.63	0.64	0.64	0.65	0.65	0.66	0.67

See footnotes on page 99.



Non-Perforated Cellular FORMLOK™ Decks

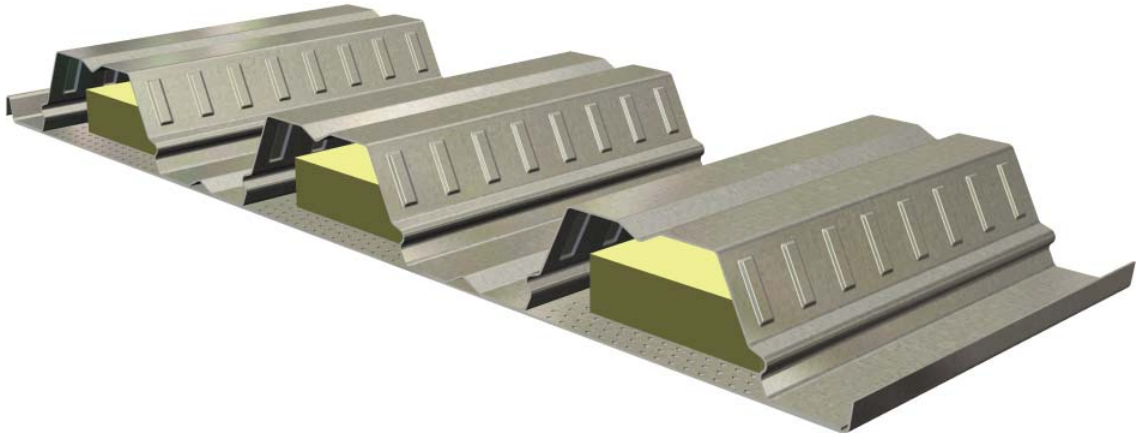

Perforated Cellular Acoustic FORMLOK™ Decks

CELLULAR DECK CONTENTS

Section Properties	110-114
Maximum Unshored Clear Span Tables	116-120
PLB-CD, PLB-CD AC, BCD or BCD AC FORMLOK	116
PLW2-CD, PLW2-CD AC, W2CD or W2CD AC FORMLOK	117
PLW3-CD, PLW3-CD AC, W3CD or W3CD AC FORMLOK	118
PLN3-CD, PLN3-CD AC, N3CD or N3CD AC FORMLOK	119
PLN-CD, PLN-CD AC, NCD or NCD AC FORMLOK	120
Allowable Uniform Load Tables	121-126
PLW2-CD or W2CD FORMLOK without concrete fill	121-123
PLW3-CD or W3CD FORMLOK without concrete fill	124-126

PLB™-CD or BCD FORMLOK™

- 1½" Deep Cellular FORMLOK Deck
- Galvanized
- PLB-CD FORMLOK used with PunchLok II System
- BCD FORMLOK used with Button Punch or 1½" Top Seam Weld



Dimensions

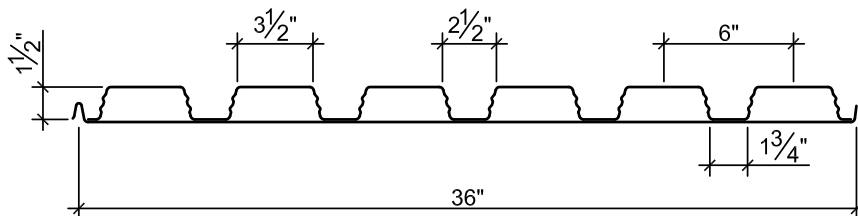

PLB-CD, PLB-CD AC,
BCD or BCD AC
FORMLOK

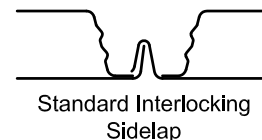

Deck Weight and Section Properties

Gage	Weight (psf)	I _d for Deflections		Positive Moment		Negative Moment		Vertical Shear	
		Single Span (in. ⁴ /ft)	Multiple Spans (in. ⁴ /ft)	+S _{eff} (in. ³ /ft)	+M (in.-kips/ft)	-S _{eff} (in. ³ /ft)	-M (in.-kips/ft)	End (lb/ft)	Interior (lb/ft)
20/20	3.6	0.416	0.416	0.279	8.4	0.382	11.4	340	510
20/18	4.1	0.454	0.454	0.287	8.6	0.428	12.8	318	369
18/20	4.1	0.535	0.535	0.417	12.5	0.453	13.6	369	612
18/18	4.6	0.587	0.587	0.428	12.8	0.552	16.5	517	667
18/16	5.1	0.631	0.631	0.437	13.1	0.575	17.2	491	524
16/18	5.3	0.704	0.704	0.587	17.6	0.629	18.8	549	757
16/16	5.8	0.759	0.759	0.599	17.9	0.700	20.9	718	821

Notes:

- Section properties are based on $F_y = 50,000$ psi.
- The gage "xx/yy" of cellular decks is defined as: First Number (xx) is the gage of the fluted top section. Second Number (yy) is the gage of the flat bottom section.
- I_d is the effective moment of inertia for deflection of simple or multiple span conditions due to uniform loads.
- S_{eff} (+ or -) is the effective section modulus. M (+ or -) is the ASD allowable moment, $M = M_n/\Omega_b$, where $\Omega_b = 1.67$ and M_n is the nominal flexural strength. M_n may be determined by multiplying the table values by Ω_b . LRFD moment may be determined by multiplying M_n by $\phi_b = 0.95$.
- Vertical Shear, V , is the ASD allowable vertical shear strength based on the horizontal shear strength of the resistance welds, where $V = V_n/\Omega$, where $\Omega = 2.35$ and V_n is the nominal vertical shear strength. V_n may be determined by multiplying the table values by Ω . LRFD vertical shear strength may be determined by multiplying V_n by $\phi = 0.65$. "END" shear strength values are applicable adjacent to supports where deck is not continuous and "INTERIOR" shear strength values are applicable adjacent to supports where deck is continuous.
- End and interior reactions shall be compared to the allowable reactions due to web crippling for fluted (non-cellular) deck of the same gage as the fluted top section of the cellular deck, as shown on page 38.
- Multiply tabulated cellular deck values by the following factors to obtain acoustical cellular deck section properties:

Deck Type	I _d for Deflection		Allowable Moment		Vertical Shear	
	Single Span	Multi Span	Positive	Negative	End	Interior
BCD Acoustical	0.97	0.97	0.99	1.00	1.00	1.00

PLW2™-CD or W2CD FORMLOK™

- 2" Deep Cellular FORMLOK Deck
- Galvanized
- PLW2-CD FORMLOK used with PunchLok II System
- W2CD FORMLOK used with Button Punch or 1½" Top Seam Weld



Dimensions

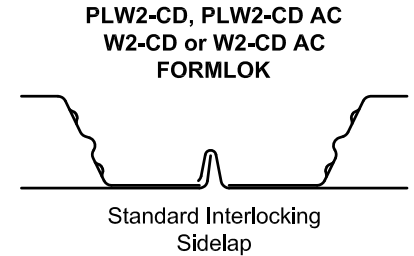
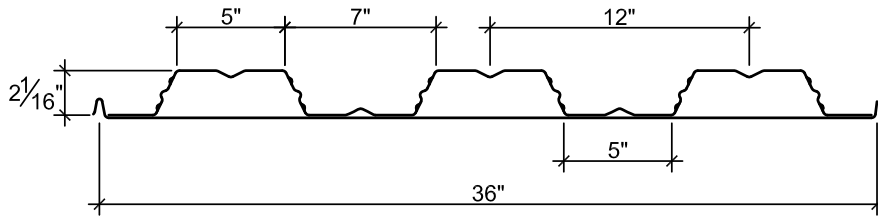

Deck Weight and Section Properties

Gage	Weight (psf)	I_d for Deflections		Positive Moment		Negative Moment		Vertical Shear	
		Single Span (in. ⁴ /ft)	Multiple Spans (in. ⁴ /ft)	+ S_{eff} (in. ³ /ft)	+M (in.-kips/ft)	- S_{eff} (in. ³ /ft)	-M (in.-kips/ft)	End (lb/ft)	Interior (lb/ft)
20/20	3.4	0.666	0.666	0.363	10.9	0.429	12.8	404	614
20/18	3.8	0.714	0.714	0.372	11.1	0.446	13.3	376	433
18/20	3.9	0.847	0.847	0.526	15.8	0.549	16.4	439	755
18/18	4.3	0.911	0.911	0.536	16.1	0.570	17.1	596	741
18/16	4.8	0.964	0.964	0.544	16.3	0.586	17.5	562	646
16/18	4.9	1.087	1.087	0.704	21.1	0.702	21.0	638	867
16/16	5.4	1.153	1.153	0.714	21.4	0.722	21.6	831	949

Notes:

- Section properties are based on $F_y = 50,000$ psi.
- The gage "xx/yy" of cellular decks is defined as: First Number (xx) is the gage of the fluted top section. Second Number (yy) is the gage of the flat bottom section.
- I_d is the effective moment of inertia for deflection of simple or multiple span conditions due to uniform loads.
- S_{eff} (+ or -) is the effective section modulus. M (+ or -) is the ASD allowable moment, $M = M_n/\Omega_b$, where $\Omega_b = 1.67$ and M_n is the nominal flexural strength. M_n may be determined by multiplying the table values by Ω_b . LRFD moment may be determined by multiplying M_n by $\phi_b = 0.95$.
- Vertical Shear, V , is the ASD allowable vertical shear strength based on the horizontal shear strength of the resistance welds, where $V = V_n/\Omega$, where $\Omega = 2.35$ and V_n is the nominal vertical shear strength. V_n may be determined by multiplying the table values by Ω . LRFD vertical shear strength may be determined by multiplying V_n by $\phi = 0.65$. "END" shear strength values are applicable adjacent to supports where deck is not continuous and "INTERIOR" shear strength values are applicable adjacent to supports where deck is continuous.
- End and interior reactions shall be compared to the allowable reactions due to web crippling for fluted (non-cellular) deck of the same gage as the fluted top section of the cellular deck, as shown on page 50.
- Multiply tabulated cellular deck values by the following factors to obtain acoustical cellular deck section properties:

Deck Type	I_d for Deflection		Allowable Moment		Vertical Shear	
	Simple	Multi Span	Positive	Negative	End	Interior
W2CD Acoustical	0.98	0.98	0.99	0.98	1.00	1.00

PLW3™-CD or W3CD FORMLOK™

- 3" Deep Cellular FORMLOK Deck
- Galvanized
- PLW3-CD FORMLOK used with PunchLok II System
- W3CD FORMLOK used with Button Punch or 1½" Top Seam Weld

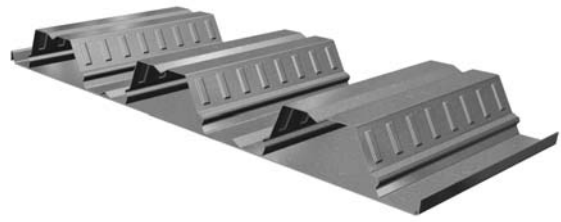

Dimensions

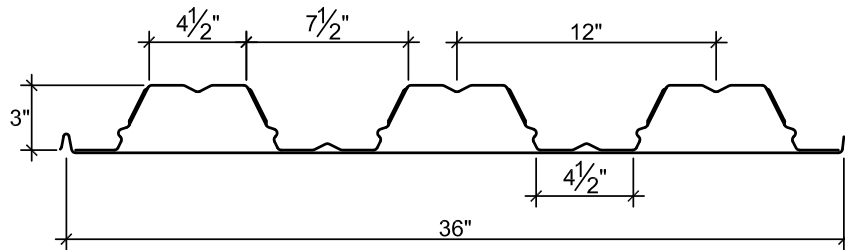

PLW3-CD, PLW3-CD AC
W3-CD or W3-CD AC
FORMLOK

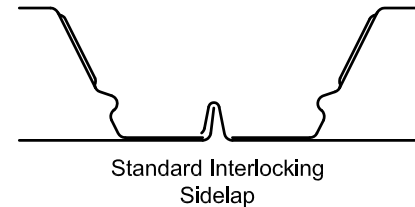

Deck Weight and Section Properties

Gage	Weight (psf)	I_d for Deflections		Positive Moment		Negative Moment		Vertical Shear	
		Single Span (in.⁴/ft)	Multiple Spans (in.⁴/ft)	+ S_{eff} (in.³/ft)	+M (in.-kips/ft)	- S_{eff} (in.³/ft)	-M (in.-kips/ft)	End (lb/ft)	Interior (lb/ft)
20/20	3.6	1.456	1.456	0.542	16.2	0.625	18.7	571	912
20/18	4.0	1.554	1.554	0.541	16.2	0.652	19.5	528	617
18/20	4.1	1.813	1.813	0.852	25.5	0.813	24.3	628	1171
18/18	4.6	1.949	1.949	0.862	25.8	0.846	25.3	869	1144
18/16	5.0	2.062	2.062	0.859	25.7	0.874	26.2	816	956
16/18	5.2	2.315	2.315	1.105	33.1	1.037	31.1	934	1354
16/16	5.7	2.453	2.453	1.123	33.6	1.073	32.1	1206	1406

Notes:

- Section properties are based on $F_y = 50,000$ psi.
- The gage "xx/yy" of cellular decks is defined as: First Number (xx) is the gage of the fluted top section. Second Number (yy) is the gage of the flat bottom section.
- I_d is the effective moment of inertia for deflection of simple or multiple span conditions due to uniform loads.
- S_{eff} (+ or -) is the effective section modulus. M (+ or -) is the ASD allowable moment, $M = M_n/\Omega_b$, where $\Omega_b = 1.67$ and M_n is the nominal flexural strength. M_n may be determined by multiplying the table values by Ω_b . LRFD moment may be determined by multiplying M_n by $\phi_b = 0.95$.
- Vertical Shear, V, is the ASD allowable vertical shear strength based on the horizontal shear strength of the resistance welds, where $V = V_n/\Omega$, where $\Omega = 2.35$ and V_n is the nominal vertical shear strength. V_n may be determined by multiplying the table values by Ω . LRFD vertical shear strength may be determined by multiplying V_n by $\phi = 0.65$. "END" shear strength values are applicable adjacent to supports where deck is not continuous and "INTERIOR" shear strength values are applicable adjacent to supports where deck is continuous.
- End and interior reactions shall be compared to the allowable reactions due to web crippling for fluted (non-cellular) deck of the same gage as the fluted top section of the cellular deck, as shown on page 68.
- Multiply tabulated cellular deck values by the following factors to obtain acoustical cellular deck section properties:

Deck Type	I_d for Deflection		Allowable Moment		Vertical Shear	
	Simple	Multi Span	Positive	Negative	End	Interior
W3CD Acoustical	0.98	0.98	0.99	0.97	1.00	1.00

PLN3™-CD or N3CD FORMLOK™

- 3" Deep Cellular FORMLOK Deck
- Galvanized
- PLN3-CD FORMLOK used with PunchLok II System
- N3CD FORMLOK used with Button Punch or 1½" Top Seam Weld

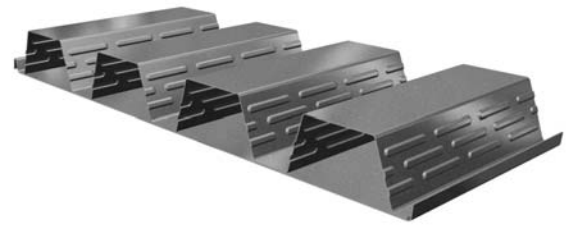

Dimensions

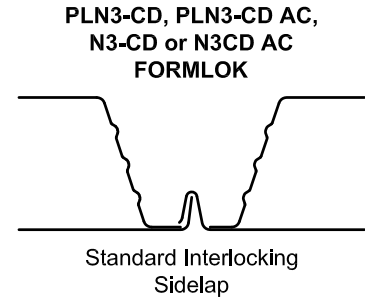
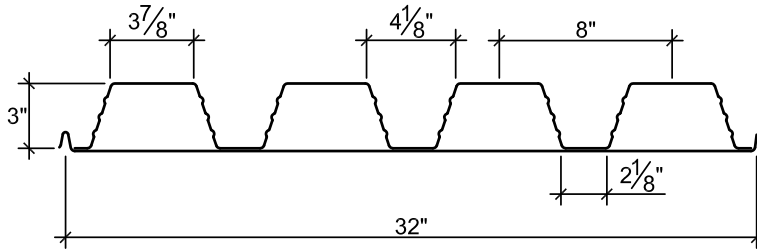

Deck Weight and Section Properties

Gage	Weight (psf)	I_d for Deflections		Positive Moment		Negative Moment		Vertical Shear	
		Single Span (in. ⁴ /ft)	Multiple Spans (in. ⁴ /ft)	+ S_{eff} (in. ³ /ft)	+M (in.-kips/ft)	- S_{eff} (in. ³ /ft)	-M (in.-kips/ft)	End (lb/ft)	Interior (lb/ft)
20/20	3.9	1.579	1.579	0.505	15.1	0.709	21.2	528	1186
20/18	4.4	1.716	1.716	0.503	15.1	0.801	24.0	489	747
18/20	4.6	2.017	2.017	0.804	24.1	0.869	26.0	579	1438
18/18	5.1	2.194	2.194	0.824	24.7	1.030	30.8	803	1426
18/16	5.7	2.346	2.346	0.829	24.8	1.077	32.2	756	1106
16/18	5.9	2.652	2.652	1.107	33.1	1.210	36.2	862	1684
16/16	6.4	2.838	2.838	1.129	33.8	1.314	39.3	1115	1734

Notes:

- Section properties are based on $F_y = 50,000$ psi.
- The gage "xx/yy" of cellular decks is defined as: First Number (xx) is the gage of the fluted top section. Second Number (yy) is the gage of the flat bottom section.
- I_d is the effective moment of inertia for deflection of simple or multiple span conditions due to uniform loads.
- S_{eff} (+ or -) is the effective section modulus. M (+ or -) is the ASD allowable moment, $M = M_n/\Omega_b$, where $\Omega_b = 1.67$ and M_n is the nominal flexural strength. M_n may be determined by multiplying the table values by Ω_b . LRFD moment may be determined by multiplying M_n by $\phi_b = 0.95$.
- Vertical Shear, V, is the ASD allowable vertical shear strength based on the horizontal shear strength of the resistance welds, where $V = V_n/\Omega$, where $\Omega = 2.35$ and V_n is the nominal vertical shear strength. V_n may be determined by multiplying the table values by Ω . LRFD vertical shear strength may be determined by multiplying V_n by $\phi = 0.65$. "END" shear strength values are applicable adjacent to supports where deck is not continuous and "INTERIOR" shear strength values are applicable adjacent to supports where deck is continuous.
- End and interior reactions shall be compared to the allowable reactions due to web crippling for fluted (non-cellular) deck of the same gage as the fluted top section of the cellular deck, as shown on page 86.
- Multiply tabulated cellular deck values by the following factors to obtain acoustical cellular deck section properties:

Deck Type	I_d for Deflection		Allowable Moment		Vertical Shear	
	Simple	Multi Span	Positive	Negative	End	Interior
N3CD Acoustical	0.97	0.99	0.99	1.00	1.00	1.00

PLN™-CD or NCD FORMLOK™

- 3" Deep Cellular FORMLOK Deck
- Galvanized
- PLN-CD FORMLOK used with PunchLok II System
- NCD FORMLOK used with Button Punch or 1½" Top Seam Weld



Dimensions

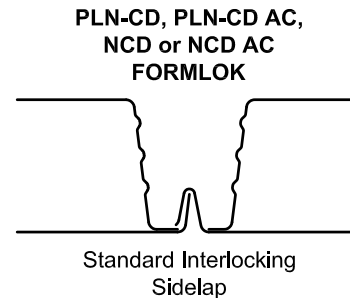
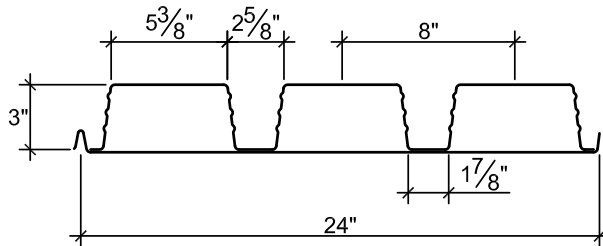

Deck Weight and Section Properties

Gage	Weight (psf)	I_d for Deflections		Positive Moment		Negative Moment		Vertical Shear	
		Single Span (in. ⁴ /ft)	Multiple Spans (in. ⁴ /ft)	+ S_{eff} (in. ³ /ft)	+M (in.-kips/ft)	- S_{eff} (in. ³ /ft)	-M (in.-kips/ft)	End (lb/ft)	Interior (lb/ft)
20/20	4.1	1.681	1.681	0.518	15.5	0.706	21.2	559	1039
20/18	4.6	1.841	1.841	0.515	15.4	0.909	27.2	522	718
18/20	4.8	2.159	2.159	0.805	24.1	0.852	25.5	608	1253
18/18	5.3	2.369	2.369	0.826	24.7	1.055	31.6	850	1275
18/16	5.8	2.544	2.544	0.843	25.2	1.318	39.5	805	966
16/18	6.1	2.881	2.881	1.121	33.6	1.199	35.9	906	1455
16/16	6.6	3.106	3.106	1.144	34.3	1.475	44.2	1181	1498

Notes:

- Section properties are based on $F_y = 50,000$ psi.
- The gage "xx/yy" of cellular decks is defined as: First Number (xx) is the gage of the fluted top section. Second Number (yy) is the gage of the flat bottom section.
- I_d is the effective moment of inertia for deflection of simple or multiple span conditions due to uniform loads.
- S_{eff} (+ or -) is the effective section modulus. M (+ or -) is the ASD allowable moment, $M = M_n/\Omega_b$, where $\Omega_b = 1.67$ and M_n is the nominal flexural strength. M_n may be determined by multiplying the table values by Ω_b . LRFD moment may be determined by multiplying M_n by $\phi_b = 0.95$.
- Vertical Shear, V, is the ASD allowable vertical shear strength based on the horizontal shear strength of the resistance welds, where $V = V_n/\Omega$, where $\Omega = 2.35$ and V_n is the nominal vertical shear strength. V_n may be determined by multiplying the table values by Ω . LRFD vertical shear strength may be determined by multiplying V_n by $\phi = 0.65$. "END" shear strength values are applicable adjacent to supports where deck is not continuous and "INTERIOR" shear strength values are applicable adjacent to supports where deck is continuous.
- End and interior reactions shall be compared to the allowable reactions due to web crippling for fluted (non-cellular) deck of the same gage as the fluted top section of the cellular deck, as shown on page 98.
- Multiply tabulated cellular deck values by the following factors to obtain acoustical cellular deck section properties:

Deck Type	I_d for Deflection		Allowable Moment		Vertical Shear	
	Simple	Multi Span	Positive	Negative	End	Interior
NCD Acoustical	0.97	0.97	0.99	1.00	1.00	1.00

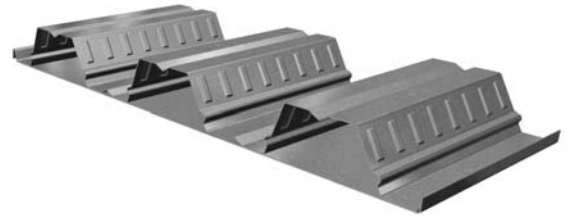

Allowable Superimposed Loads and Diaphragm Values for Cellular FORMLOK Decks with Concrete Fill

1. Allowable superimposed loads and allowable diaphragm shear strengths and flexibility factors shown in the FORMLOK tables on pages 40-108 for a given concrete type and thickness may be applied to cellular FORMLOK deck sections with a fluted top section of the same profile and gage, with or without acoustical perforations in the flat bottom section of the cellular deck.

Footnotes for Maximum Unshored Clear Span Tables

1. Shoring calculations based on the following:
 - Deck supporting dead load of concrete plus 20 psf uniform construction load or 150 pound concentrated construction live load for flexure. 4 psf is added for normal weight concrete and 3 psf is added for light weight concrete to account for ponding due to deck deflection between support members.
 - Dead load deflection limited to $L/180$ of span length, not to exceed 3/4".
 - Minimum end bearing of 2" and interior bearing of 2" for PLB-CD, PLB-CD AC, BCD and BCD AC FORMLOK.
Minimum end bearing of 2" and interior bearing of 4" for PLW2-CD, PLW2-CD AC, W2CD and W2CD AC FORMLOK.
Minimum end bearing of 2" and interior bearing of 6" for PLW3-CD, PLW3-CD AC, W3CD and W3CD AC FORMLOK.
Minimum end bearing of 2" and interior bearing of 4" for PLN3-CD, PLN3-CD AC, N3CD and N3CD AC FORMLOK.
Minimum end bearing of 2" and interior bearing of 2" for PLN-CD, PLN-CD AC, NCD and NCD AC FORMLOK.
2. Total slab depth is nominal depth from top of concrete to bottom of steel deck.

Footnotes for Allowable Uniform Load Tables

1. Stress = Allowable uniform load based on maximum allowable flexural stress in deck.
2. Shear = Allowable uniform load governed by vertical shear strength based on horizontal shear strength of the resistance welds.
3. $L/360$, $L/240$ or $L/180$ = Uniform load which produces selected deflection in deck.
4. The symbol ♦♦♦ indicates allowable uniform load based on deflection exceeds allowable uniform load based on stress or shear.
5. Nominal uniform loads based on flexural stress may be determined by multiplying the allowable uniform loads in the table by $\Omega_b = 1.67$. LRFD uniform loads may be determined by multiplying nominal uniform loads by $\phi_b = 0.95$.
6. Nominal uniform loads based on vertical shear may be determined by multiplying the allowable uniform loads in the table by $\Omega_b = 2.35$. LRFD uniform loads may be determined by multiplying nominal uniform loads by $\phi_b = 0.65$.

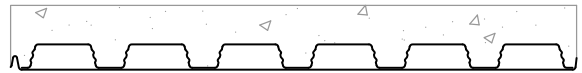

Maximum Unshored Clear Span (ft-in.)

Profile	Deck Gage	Number of Deck Spans	Total Slab Depth (in.)								
			Normal Weight Concrete (145 pcf)					Light Weight Concrete (110 pcf)			
			3½	4	4½	5	6	3½	4	4¾	5¾
PLB-CD, PLB-CD AC, BCD or BCD AC FORMLOK	20/20	1	8'-8"	8'-3"	7'-11"	7'-7"	7'-0"	9'-6"	9'-0"	8'-6"	7'-11"
		2	10'-2"	9'-8"	9'-2"	8'-10"	8'-2"	11'-1"	10'-7"	9'-11"	9'-2"
		3	10'-3"	9'-9"	9'-4"	8'-11"	8'-3"	10'-8"	10'-8"	10'-0"	9'-3"
	20/18	1	8'-10"	8'-5"	8'-0"	7'-8"	7'-1"	9'-7"	9'-2"	8'-7"	8'-0"
		2	10'-0"	9'-1"	8'-4"	7'-8"	6'-7"	11'-3"	10'-8"	9'-6"	8'-3"
		3	10'-5"	9'-6"	8'-8"	8'-0"	6'-11"	10'-8"	10'-8"	9'-11"	8'-8"
	18/20	1	10'-6"	10'-0"	9'-7"	9'-3"	8'-3"	11'-4"	10'-11"	10'-3"	9'-7"
		2	11'-8"	11'-1"	10'-7"	10'-2"	9'-5"	12'-7"	12'-1"	11'-4"	10'-7"
		3	10'-8"	10'-8"	10'-8"	10'-6"	9'-9"	10'-8"	10'-8"	10'-8"	10'-8"
	18/18	1	10'-10"	10'-3"	9'-10"	9'-6"	8'-11"	11'-7"	11'-2"	10'-6"	9'-10"
		2	12'-10"	12'-3"	11'-8"	11'-3"	10'-5"	13'-10"	13'-3"	12'-6"	11'-8"
		3	10'-8"	10'-8"	10'-8"	10'-8"	10'-8"	10'-8"	10'-8"	10'-8"	10'-8"
	18/16	1	11'-0"	10'-6"	10'-1"	9'-9"	9'-1"	11'-9"	11'-4"	10'-9"	10'-1"
		2	13'-4"	12'-7"	11'-8"	10'-9"	9'-3"	14'-7"	13'-10"	12'-11"	11'-7"
		3	10'-8"	10'-8"	10'-8"	10'-8"	9'-8"	10'-8"	10'-8"	10'-8"	10'-8"
	16/18	1	11'-4"	10'-11"	10'-5"	10'-1"	9'-5"	12'-1"	11'-8"	11'-2"	10'-5"
		2	13'-8"	13'-0"	12'-5"	11'-11"	11'-1"	14'-8"	14'-1"	13'-4"	12'-5"
		3	10'-8"	10'-8"	10'-8"	10'-8"	10'-8"	10'-8"	10'-8"	10'-8"	10'-8"
16/16	1	11'-6"	11'-1"	10'-8"	10'-3"	9'-8"	12'-3"	11'-10"	11'-4"	10'-8"	
	2	14'-5"	13'-11"	13'-6"	13'-1"	12'-2"	15'-3"	14'-9"	14'-1"	13'-5"	
	3	10'-8"	10'-8"	10'-8"	10'-8"	10'-8"	10'-8"	10'-8"	10'-8"	10'-8"	

Notes:

1. Shoring is required for span lengths greater than those shown above.
2. Span lengths listed in **bold italic** are restricted by a maximum sheet length of 32 ft as limited by production capabilities.
3. See Footnote 1 on page 115 for required bearing length.
4. See additional footnotes on page 115.



Maximum Unshored Clear Span (ft.-in.)

Profile	Deck Gage	Number of Deck Spans	Total Slab Depth (in.)								
			Normal Weight Concrete (145 pcf)					Light Weight Concrete (110 pcf)			
			4	4½	5	5½	6½	4	4½	5¼	6¼
PLW2-CD, PLW2-CD AC, W2CD or W2CD AC FORMLOK	20/20	1	9'-11"	9'-5"	9'-0"	8'-8"	8'-1"	10'-10"	10'-4"	9'-9"	9'-1"
		2	11'-6"	11'-0"	10'-6"	10'-1"	9'-4"	12'-6"	12'-0"	11'-4"	10'-7"
		3	10'-8"	10'-8"	10'-7"	10'-2"	9'-5"	10'-8"	10'-8"	10'-8"	10'-8"
	20/18	1	10'-0"	9'-6"	9'-1"	8'-9"	8'-0"	10'-11"	10'-5"	9'-10"	9'-2"
		2	10'-10"	9'-11"	9'-1"	8'-5"	7'-4"	12'-8"	11'-10"	10'-7"	9'-3"
		3	10'-8"	10'-4"	9'-6"	8'-10"	7'-8"	10'-8"	10'-8"	10'-8"	9'-8"
	18/20	1	11'-8"	11'-3"	10'-10"	10'-6"	9'-4"	12'-5"	12'-0"	11'-6"	10'-11"
		2	13'-0"	12'-5"	11'-11"	11'-5"	10'-8"	14'-1"	13'-6"	12'-9"	12'-0"
		3	10'-8"	10'-8"	10'-8"	10'-8"	10'-8"	10'-8"	10'-8"	10'-8"	10'-8"
	18/18	1	11'-10"	11'-6"	11'-1"	10'-9"	10'-1"	12'-7"	12'-2"	11'-9"	11'-2"
		2	13'-2"	12'-7"	12'-1"	11'-8"	10'-10"	14'-4"	13'-9"	13'-0"	12'-2"
		3	10'-8"	10'-8"	10'-8"	10'-8"	10'-8"	10'-8"	10'-8"	10'-8"	10'-8"
	18/16	1	12'-0"	11'-7"	11'-3"	10'-11"	10'-2"	12'-9"	12'-4"	11'-10"	11'-4"
		2	13'-4"	12'-9"	12'-3"	11'-9"	10'-10"	14'-6"	13'-11"	13'-2"	12'-4"
		3	10'-8"	10'-8"	10'-8"	10'-8"	10'-8"	10'-8"	10'-8"	10'-8"	10'-8"
	16/18	1	12'-4"	11'-11"	11'-7"	11'-4"	10'-9"	13'-1"	12'-8"	12'-2"	11'-8"
		2	14'-7"	13'-11"	13'-4"	12'-10"	12'-0"	15'-9"	15'-2"	14'-4"	13'-5"
		3	10'-8"	10'-8"	10'-8"	10'-8"	10'-8"	10'-8"	10'-8"	10'-8"	10'-8"
16/16	1	12'-6"	12'-1"	11'-9"	11'-6"	10'-11"	13'-3"	12'-10"	12'-4"	11'-10"	
	2	14'-9"	14'-1"	13'-6"	13'-0"	12'-2"	16'-0"	15'-4"	14'-6"	13'-8"	
	3	10'-8"	10'-8"	10'-8"	10'-8"	10'-8"	10'-8"	10'-8"	10'-8"	10'-8"	

Notes:

1. Shoring is required for span lengths greater than those shown above.
2. Span lengths listed in **bold italic** are restricted by a maximum sheet length of 32 ft as limited by production capabilities.
3. See Footnote 1 on page 115 for required bearing length.
4. See additional footnotes on page 115.

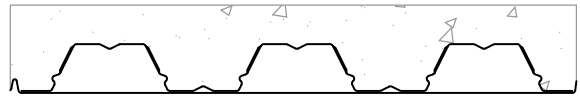

Maximum Unshored Clear Span (ft-in.)

Profile	Deck Gage	Number of Deck Spans	Total Slab Depth (in.)								
			Normal Weight Concrete (145 pcf)					Light Weight Concrete (110 pcf)			
			5	5½	6	6½	7½	5	5½	6¼	7¼
PLW3-CD, PLW3-CD AC, W3CD or W3CD AC FORMLOK	20/20	1	12'-0"	11'-5"	11'-0"	10'-7"	9'-10"	13'-3"	12'-8"	12'-0"	11'-2"
		2	13'-2"	12'-7"	12'-2"	11'-4"	9'-11"	14'-4"	13'-10"	13'-2"	12'-4"
		3	10'-8"	10'-8"	10'-8"	10'-8"	10'-8"	10'-8"	10'-8"	10'-8"	10'-8"
	20/18	1	11'-11"	11'-5"	10'-11"	10'-7"	9'-10"	13'-3"	12'-8"	11'-11"	11'-2"
		2	13'-5"	12'-11"	11'-11"	11'-1"	9'-9"	14'-8"	14'-2"	13'-5"	12'-4"
		3	10'-8"	10'-8"	10'-8"	10'-8"	10'-2"	10'-8"	10'-8"	10'-8"	10'-8"
	18/20	1	13'-7"	13'-3"	12'-11"	12'-7"	12'-1"	14'-6"	14'-1"	13'-7"	13'-0"
		2	15'-0"	14'-4"	13'-10"	13'-4"	12'-6"	16'-0"	15'-9"	14'-11"	14'-1"
		3	10'-8"	10'-8"	10'-8"	10'-8"	10'-8"	10'-8"	10'-8"	10'-8"	10'-8"
	18/18	1	13'-10"	13'-5"	13'-1"	12'-10"	12'-4"	14'-9"	14'-4"	13'-10"	13'-3"
		2	15'-3"	14'-8"	14'-1"	13'-7"	12'-9"	16'-0"	16'-0"	15'-3"	14'-4"
		3	10'-8"	10'-8"	10'-8"	10'-8"	10'-8"	10'-8"	10'-8"	10'-8"	10'-8"
	18/16	1	14'-0"	13'-7"	13'-3"	13'-0"	12'-5"	14'-11"	14'-6"	14'-0"	13'-5"
		2	15'-6"	14'-11"	14'-4"	13'-10"	13'-0"	16'-0"	16'-0"	15'-6"	14'-7"
		3	10'-8"	10'-8"	10'-8"	10'-8"	10'-8"	10'-8"	10'-8"	10'-8"	10'-8"
	16/18	1	14'-5"	14'-0"	13'-8"	13'-4"	12'-10"	15'-4"	14'-11"	14'-4"	13'-10"
		2	16'-0"	16'-0"	15'-7"	15'-0"	14'-1"	16'-0"	16'-0"	16'-0"	15'-10"
		3	10'-8"	10'-8"	10'-8"	10'-8"	10'-8"	10'-8"	10'-8"	10'-8"	10'-8"
16/16	1	14'-7"	14'-2"	13'-10"	13'-6"	13'-0"	15'-6"	15'-1"	14'-7"	14'-0"	
	2	16'-0"	16'-0"	15'-10"	15'-3"	14'-4"	16'-0"	16'-0"	16'-0"	16'-0"	
	3	10'-8"	10'-8"	10'-8"	10'-8"	10'-8"	10'-8"	10'-8"	10'-8"	10'-8"	

Notes:

1. Shoring is required for span lengths greater than those shown above.
2. Span lengths listed in **bold italic** are restricted by a maximum sheet length of 32 ft as limited by production capabilities.
3. See Footnote 1 on page 115 for required bearing length.
4. See additional footnotes on page 115.

PLN3™-CD, PLN3™-CD AC, N3CD or N3CD AC FORMLOK™

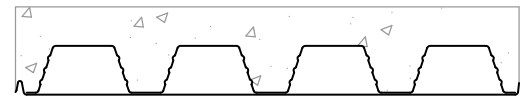

Maximum Unshored Clear Span (ft.-in.)

Profile	Deck Gage	Number of Deck Spans	Total Slab Depth (in.)								
			Normal Weight Concrete (145 pcf)					Light Weight Concrete (110 pcf)			
			5	5½	6	6½	7½	5	5½	6¼	7¼
PLN3-CD, PLN3-CD AC, N3CD or N3CD AC FORMLOK	20/20	1	11'-11"	11'-4"	10'-10"	10'-5"	9'-8"	13'-1"	12'-6"	11'-9"	10'-11"
		2	13'-9"	13'-1"	12'-7"	12'-1"	11'-2"	15'-3"	14'-6"	13'-8"	12'-8"
		3	10'-8"	10'-8"	10'-8"	10'-8"	10'-8"	10'-8"	10'-8"	10'-8"	10'-8"
	20/18	1	11'-10"	11'-3"	10'-9"	10'-4"	9'-8"	13'-0"	12'-5"	11'-8"	10'-11"
		2	13'-8"	13'-0"	12'-6"	12'-0"	11'-2"	15'-1"	14'-5"	13'-7"	12'-8"
		3	10'-8"	10'-8"	10'-8"	10'-8"	10'-8"	10'-8"	10'-8"	10'-8"	10'-8"
	18/20	1	14'-2"	13'-9"	13'-5"	13'-1"	11'-11"	15'-1"	14'-8"	14'-1"	13'-6"
		2	16'-0"	15'-5"	14'-9"	14'-3"	13'-4"	16'-0"	16'-0"	15'-11"	14'-11"
		3	10'-8"	10'-8"	10'-8"	10'-8"	10'-8"	10'-8"	10'-8"	10'-8"	10'-8"
	18/18	1	14'-5"	14'-0"	13'-8"	13'-4"	12'-8"	15'-4"	14'-11"	14'-4"	13'-9"
		2	16'-0"	16'-0"	16'-0"	15'-6"	14'-6"	16'-0"	16'-0"	16'-0"	16'-0"
		3	10'-8"	10'-8"	10'-8"	10'-8"	10'-8"	10'-8"	10'-8"	10'-8"	10'-8"
	18/16	1	14'-8"	14'-3"	13'-10"	13'-6"	12'-9"	15'-7"	15'-1"	14'-7"	13'-11"
		2	16'-0"	16'-0"	16'-0"	15'-9"	14'-9"	16'-0"	16'-0"	16'-0"	16'-0"
		3	10'-8"	10'-8"	10'-8"	10'-8"	10'-8"	10'-8"	10'-8"	10'-8"	10'-8"
	16/18	1	15'-1"	14'-8"	14'-3"	13'-11"	13'-4"	16'-0"	15'-7"	15'-0"	14'-4"
		2	16'-0"	16'-0"	16'-0"	16'-0"	15'-8"	16'-0"	16'-0"	16'-0"	16'-0"
		3	10'-8"	10'-8"	10'-8"	10'-8"	10'-8"	10'-8"	10'-8"	10'-8"	10'-8"
16/16	1	15'-4"	14'-10"	14'-6"	14'-2"	13'-7"	16'-3"	15'-10"	15'-3"	14'-7"	
	2	16'-0"	16'-0"	16'-0"	16'-0"	16'-0"	16'-0"	16'-0"	16'-0"	16'-0"	
	3	10'-8"	10'-8"	10'-8"	10'-8"	10'-8"	10'-8"	10'-8"	10'-8"	10'-8"	10'-8"

Notes:

1. Shoring is required for span lengths greater than those shown above.
2. Span lengths listed in **bold italic** are restricted by a maximum sheet length of 32 ft as limited by production capabilities.
3. See Footnote 1 on page 115 for required bearing length.
4. See additional footnotes on page 115.

PLN™-CD, PLN™-CD AC, NCD or NCD AC FORMLOK™

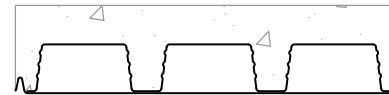

Maximum Unshored Clear Span (ft-in.)

Profile	Deck Gage	Number of Deck Spans	Total Slab Depth (in.)								
			Normal Weight Concrete (145 pcf)					Light Weight Concrete (110 pcf)			
			5	5½	6	6½	7½	5	5½	6¼	7¼
PLN-CD, PLN-CD AC, NCD or NCD AC FORMLOK	20/20	1	12'-5"	11'-10"	11'-3"	10'-10"	10'-0"	13'-8"	13'-0"	12'-3"	11'-4"
		2	14'-6"	13'-9"	13'-1"	12'-6"	11'-7"	15'-11"	15'-2"	14'-2"	13'-2"
		3	10'-8"	10'-8"	10'-8"	10'-8"	10'-8"	10'-8"	10'-8"	10'-8"	10'-8"
	20/18	1	12'-4"	11'-9"	11'-2"	10'-9"	10'-0"	13'-7"	12'-11"	12'-1"	11'-3"
		2	14'-4"	13'-7"	13'-0"	12'-5"	11'-6"	15'-10"	15'-0"	14'-1"	13'-1"
		3	10'-8"	10'-8"	10'-8"	10'-8"	10'-8"	10'-8"	10'-8"	10'-8"	10'-8"
	18/20	1	14'-9"	14'-3"	13'-10"	13'-6"	12'-10"	15'-8"	15'-2"	14'-7"	13'-11"
		2	15'-3"	14'-7"	14'-0"	13'-5"	12'-6"	16'-0"	15'-10"	15'-0"	14'-0"
		3	10'-8"	10'-8"	10'-8"	10'-8"	10'-8"	10'-8"	10'-8"	10'-8"	10'-8"
	18/18	1	15'-0"	14'-7"	14'-2"	13'-9"	12'-11"	16'-0"	15'-6"	14'-10"	14'-2"
		2	16'-0"	16'-0"	15'-5"	14'-10"	13'-10"	16'-0"	16'-0"	16'-0"	15'-6"
		3	10'-8"	10'-8"	10'-8"	10'-8"	10'-8"	10'-8"	10'-8"	10'-8"	10'-8"
	18/16	1	15'-3"	14'-9"	14'-4"	14'-0"	13'-1"	16'-2"	15'-9"	15'-1"	14'-5"
		2	16'-0"	16'-0"	16'-0"	16'-0"	15'-1"	16'-0"	16'-0"	16'-0"	16'-0"
		3	10'-8"	10'-8"	10'-8"	10'-8"	10'-8"	10'-8"	10'-8"	10'-8"	10'-8"
16/18	1	15'-9"	15'-3"	14'-10"	14'-5"	13'-10"	16'-8"	16'-2"	15'-6"	14'-10"	
	2	16'-0"	16'-0"	16'-0"	15'-11"	14'-10"	16'-0"	16'-0"	16'-0"	16'-0"	
	3	10'-8"	10'-8"	10'-8"	10'-8"	10'-8"	10'-8"	10'-8"	10'-8"	10'-8"	
16/16	1	16'-0"	15'-6"	15'-1"	14'-8"	14'-1"	16'-11"	16'-5"	15'-9"	15'-1"	
	2	16'-0"	16'-0"	16'-0"	16'-0"	16'-0"	16'-0"	16'-0"	16'-0"	16'-0"	
	3	10'-8"	10'-8"	10'-8"	10'-8"	10'-8"	10'-8"	10'-8"	10'-8"	10'-8"	

Notes:

1. Shoring is required for span lengths greater than those shown above.
2. Span lengths listed in **bold italic** are restricted by a maximum sheet length of 32 ft as limited by production capabilities.
3. See Footnote 1 on page 115 for required bearing length.
4. See additional footnotes on page 115.

PLW2™-CD or W2CD FORMLOK™

Without Concrete Fill



Allowable Uniform Loads (psf)

SPAN	DECK GAGE	CRITERIA	SPAN (ft-in.)																
			6'-0"	6'-6"	7'-0"	7'-6"	8'-0"	8'-6"	9'-0"	9'-6"	10'-0"	10'-8"	11'-0"	11'-6"	12'-0"	12'-6"	13'-0"	13'-6"	14'-0"
SINGLE	20/20	Stress	202	172	148	129	113	100	90	80	73	64	60	55	50	46	43	40	37
		Shear	135	124	115	108	101	95	90	85	81	76	73	70	67	65	62	60	58
		L/360	♦♦♦	106	85	69	57	47	40	34	29	24	22	19	17	15	13	12	11
		L/240	♦♦♦	♦♦♦	♦♦♦	104	85	71	60	51	44	36	33	29	25	22	20	18	16
		L/180	♦♦♦	♦♦♦	♦♦♦	♦♦♦	♦♦♦	95	80	68	58	48	44	38	34	30	27	24	21
		Stress	207	176	152	132	116	103	92	82	74	65	61	56	52	48	44	41	38
	20/18	Shear	126	116	108	101	94	89	84	79	75	71	69	66	63	60	58	56	54
		L/360	♦♦♦	114	91	74	61	51	43	36	31	26	23	21	18	16	14	13	11
		L/240	♦♦♦	♦♦♦	♦♦♦	♦♦♦	92	76	64	55	47	39	35	31	27	24	21	19	17
		L/180	♦♦♦	♦♦♦	♦♦♦	♦♦♦	♦♦♦	♦♦♦	♦♦♦	73	62	51	47	41	36	32	28	25	23
		Stress	292	249	215	187	164	146	130	117	105	92	87	80	73	67	62	58	54
		Shear	146	135	125	117	110	103	98	92	88	82	80	76	73	70	68	65	63
	18/20	L/360	♦♦♦	135	108	88	72	60	51	43	37	31	28	24	21	19	17	15	14
		L/240	♦♦♦	♦♦♦	♦♦♦	♦♦♦	109	91	76	65	56	46	42	37	32	28	25	23	20
		L/180	♦♦♦	♦♦♦	♦♦♦	♦♦♦	♦♦♦	♦♦♦	♦♦♦	87	74	61	56	49	43	38	34	30	27
		Stress	298	254	219	191	168	148	132	119	107	94	89	81	74	69	63	59	55
		Shear	199	183	170	159	149	140	132	125	119	112	108	104	99	95	92	88	85
		L/360	185	145	116	95	78	65	55	47	40	33	30	26	23	20	18	16	15
18/18	L/240	♦♦♦	♦♦♦	♦♦♦	142	117	97	82	70	60	49	45	39	35	31	27	24	22	
	L/180	♦♦♦	♦♦♦	♦♦♦	♦♦♦	♦♦♦	130	109	93	80	66	60	52	46	41	36	32	29	
	Stress	300	258	222	193	170	151	134	121	109	96	90	82	76	70	64	60	56	
	Shear	187	173	161	150	140	132	125	118	112	105	102	98	94	90	86	83	80	
	18/16	L/360	♦♦♦	154	123	100	82	69	58	49	42	35	32	28	24	22	19	17	15
		L/240	♦♦♦	♦♦♦	♦♦♦	♦♦♦	124	103	87	74	63	52	48	42	37	32	29	26	23
L/180		♦♦♦	♦♦♦	♦♦♦	♦♦♦	♦♦♦	♦♦♦	116	98	84	69	63	56	49	43	38	34	31	
Stress		300	300	287	250	220	195	174	156	141	124	116	106	98	90	83	77	72	
Shear		213	196	182	170	159	150	142	134	128	120	116	111	106	102	98	94	91	
L/360		♦♦♦	173	139	113	93	77	65	56	48	39	36	31	28	24	22	19	17	
16/18	L/240	♦♦♦	♦♦♦	♦♦♦	169	139	116	98	83	71	59	54	47	41	37	32	29	26	
	L/180	♦♦♦	♦♦♦	♦♦♦	♦♦♦	♦♦♦	♦♦♦	131	111	95	78	72	63	55	49	43	39	35	
	Stress	300	300	291	254	223	198	176	158	143	125	118	108	99	91	84	78	73	
	Shear	277	256	237	222	208	196	185	175	166	156	151	145	139	133	128	123	119	
	16/16	L/360	234	184	147	120	99	82	69	59	50	42	38	33	29	26	23	21	18
		L/240	♦♦♦	♦♦♦	221	179	148	123	104	88	76	62	57	50	44	39	34	31	28
L/180		♦♦♦	♦♦♦	♦♦♦	♦♦♦	197	164	138	118	101	83	76	66	58	52	46	41	37	

See footnotes on page 115.

PLW2™-CD or W2CD FORMLOK™

■ Without Concrete Fill



Allowable Uniform Loads (psf)

SPAN	DECK GAGE	CRITERIA	SPAN (ft-in.)																		
			6'-0"	6'-6"	7'-0"	7'-6"	8'-0"	8'-6"	9'-0"	9'-6"	10'-0"	10'-8"	11'-0"	11'-6"	12'-0"	12'-6"	13'-0"	13'-6"	14'-0"		
DOUBLE	20/20	Stress	238	203	175	153	134	119	106	95	86	75	71	65	60	55	51	47	44		
		Shear	164	151	140	131	123	116	109	103	98	92	89	85	82	79	76	73	70		
		L/360	◆◆◆	◆◆◆	◆◆◆	◆◆◆	◆◆◆	◆◆◆	114	96	82	70	58	53	46	41	36	32	29	26	
		L/240	◆◆◆	◆◆◆	◆◆◆	◆◆◆	◆◆◆	◆◆◆	◆◆◆	◆◆◆	◆◆◆	◆◆◆	◆◆◆	◆◆◆	◆◆◆	◆◆◆	◆◆◆	54	48	43	38
		L/180	◆◆◆	◆◆◆	◆◆◆	◆◆◆	◆◆◆	◆◆◆	◆◆◆	◆◆◆	◆◆◆	◆◆◆	◆◆◆	◆◆◆	◆◆◆	◆◆◆	◆◆◆	◆◆◆	◆◆◆	◆◆◆	◆◆◆
	20/18	Stress	248	211	182	159	139	123	110	99	89	78	74	67	62	57	53	49	45		
		Shear	116	107	99	93	87	82	77	73	69	65	63	60	58	56	53	51	50		
		L/360	◆◆◆	◆◆◆	◆◆◆	◆◆◆	◆◆◆	◆◆◆	◆◆◆	◆◆◆	◆◆◆	◆◆◆	62	56	49	44	39	34	31	27	
		L/240	◆◆◆	◆◆◆	◆◆◆	◆◆◆	◆◆◆	◆◆◆	◆◆◆	◆◆◆	◆◆◆	◆◆◆	◆◆◆	◆◆◆	◆◆◆	◆◆◆	◆◆◆	51	46	41	
		L/180	◆◆◆	◆◆◆	◆◆◆	◆◆◆	◆◆◆	◆◆◆	◆◆◆	◆◆◆	◆◆◆	◆◆◆	◆◆◆	◆◆◆	◆◆◆	◆◆◆	◆◆◆	◆◆◆	◆◆◆	◆◆◆	◆◆◆
18/20	Stress	300	260	224	195	172	152	136	122	110	97	91	83	76	70	65	60	56			
	Shear	195	180	167	156	146	138	130	123	117	110	106	102	98	94	90	87	84			
	L/360	◆◆◆	◆◆◆	◆◆◆	◆◆◆	◆◆◆	◆◆◆	◆◆◆	122	104	89	73	67	59	52	46	41	36	33		
	L/240	◆◆◆	◆◆◆	◆◆◆	◆◆◆	◆◆◆	◆◆◆	◆◆◆	◆◆◆	◆◆◆	◆◆◆	◆◆◆	◆◆◆	◆◆◆	◆◆◆	◆◆◆	69	61	54	49	
	L/180	◆◆◆	◆◆◆	◆◆◆	◆◆◆	◆◆◆	◆◆◆	◆◆◆	◆◆◆	◆◆◆	◆◆◆	◆◆◆	◆◆◆	◆◆◆	◆◆◆	◆◆◆	◆◆◆	◆◆◆	◆◆◆	◆◆◆	
18/18	Stress	300	270	233	203	178	158	141	126	114	100	94	86	79	73	67	63	58			
	Shear	198	182	169	158	148	139	132	125	119	111	108	103	99	95	91	88	85			
	L/360	◆◆◆	◆◆◆	◆◆◆	◆◆◆	◆◆◆	◆◆◆	◆◆◆	132	112	96	79	72	63	56	49	44	39	35		
	L/240	◆◆◆	◆◆◆	◆◆◆	◆◆◆	◆◆◆	◆◆◆	◆◆◆	◆◆◆	◆◆◆	◆◆◆	◆◆◆	◆◆◆	◆◆◆	◆◆◆	◆◆◆	◆◆◆	66	59	52	
	L/180	◆◆◆	◆◆◆	◆◆◆	◆◆◆	◆◆◆	◆◆◆	◆◆◆	◆◆◆	◆◆◆	◆◆◆	◆◆◆	◆◆◆	◆◆◆	◆◆◆	◆◆◆	◆◆◆	◆◆◆	◆◆◆	◆◆◆	
18/16	Stress	300	277	239	208	183	162	145	130	117	103	97	89	81	75	69	64	60			
	Shear	172	159	148	138	129	122	115	109	103	97	94	90	86	83	80	77	74			
	L/360	◆◆◆	◆◆◆	◆◆◆	◆◆◆	◆◆◆	◆◆◆	◆◆◆	◆◆◆	◆◆◆	102	84	76	67	59	52	46	41	37		
	L/240	◆◆◆	◆◆◆	◆◆◆	◆◆◆	◆◆◆	◆◆◆	◆◆◆	◆◆◆	◆◆◆	◆◆◆	◆◆◆	◆◆◆	◆◆◆	◆◆◆	◆◆◆	◆◆◆	◆◆◆	62	56	
	L/180	◆◆◆	◆◆◆	◆◆◆	◆◆◆	◆◆◆	◆◆◆	◆◆◆	◆◆◆	◆◆◆	◆◆◆	◆◆◆	◆◆◆	◆◆◆	◆◆◆	◆◆◆	◆◆◆	◆◆◆	◆◆◆	◆◆◆	
16/18	Stress	300	300	286	250	219	194	173	156	140	123	116	106	97	90	83	77	72			
	Shear	231	213	198	185	173	163	154	146	139	130	126	120	115	111	107	103	99			
	L/360	◆◆◆	◆◆◆	◆◆◆	◆◆◆	◆◆◆	◆◆◆	◆◆◆	◆◆◆	◆◆◆	134	115	94	86	75	66	59	52	47	42	
	L/240	◆◆◆	◆◆◆	◆◆◆	◆◆◆	◆◆◆	◆◆◆	◆◆◆	◆◆◆	◆◆◆	◆◆◆	◆◆◆	◆◆◆	◆◆◆	◆◆◆	◆◆◆	◆◆◆	88	78	70	63
	L/180	◆◆◆	◆◆◆	◆◆◆	◆◆◆	◆◆◆	◆◆◆	◆◆◆	◆◆◆	◆◆◆	◆◆◆	◆◆◆	◆◆◆	◆◆◆	◆◆◆	◆◆◆	◆◆◆	◆◆◆	◆◆◆	◆◆◆	◆◆◆
16/16	Stress	300	300	295	257	226	200	178	160	144	127	119	109	100	92	85	79	74			
	Shear	253	234	217	203	190	179	169	160	152	142	138	132	127	122	117	113	108			
	L/360	◆◆◆	◆◆◆	◆◆◆	◆◆◆	◆◆◆	◆◆◆	◆◆◆	◆◆◆	◆◆◆	167	142	121	100	91	80	70	62	55	49	44
	L/240	◆◆◆	◆◆◆	◆◆◆	◆◆◆	◆◆◆	◆◆◆	◆◆◆	◆◆◆	◆◆◆	◆◆◆	◆◆◆	◆◆◆	◆◆◆	◆◆◆	◆◆◆	◆◆◆	◆◆◆	83	74	66
	L/180	◆◆◆	◆◆◆	◆◆◆	◆◆◆	◆◆◆	◆◆◆	◆◆◆	◆◆◆	◆◆◆	◆◆◆	◆◆◆	◆◆◆	◆◆◆	◆◆◆	◆◆◆	◆◆◆	◆◆◆	◆◆◆	◆◆◆	◆◆◆

See footnotes on page 115.

PLW2™-CD or W2CD FORMLOK™

■ Without Concrete Fill



Allowable Uniform Loads (psf)

SPAN	DECK GAGE	CRITERIA	SPAN (ft-in.)									
			6'-0"	6'-6"	7'-0"	7'-6"	8'-0"	8'-6"	9'-0"	9'-6"	10'-0"	10'-8"
TRIPLE	20/20	Stress	298	254	219	191	168	148	132	119	107	94
		Shear	168	155	144	135	126	119	112	106	101	95
		L/360	◆◆◆	◆◆◆	◆◆◆	130	107	89	75	64	55	45
		L/240	◆◆◆	◆◆◆	◆◆◆	◆◆◆	◆◆◆	◆◆◆	◆◆◆	96	82	68
		L/180	◆◆◆	◆◆◆	◆◆◆	◆◆◆	◆◆◆	◆◆◆	◆◆◆	◆◆◆	◆◆◆	90
	20/18	Stress	300	264	227	198	174	154	138	124	111	98
		Shear	121	111	103	96	90	85	80	76	72	68
		L/360	◆◆◆	◆◆◆	◆◆◆	◆◆◆	◆◆◆	◆◆◆	◆◆◆	69	59	48
		L/240	◆◆◆	◆◆◆	◆◆◆	◆◆◆	◆◆◆	◆◆◆	◆◆◆	◆◆◆	◆◆◆	◆◆◆
		L/180	◆◆◆	◆◆◆	◆◆◆	◆◆◆	◆◆◆	◆◆◆	◆◆◆	◆◆◆	◆◆◆	◆◆◆
	18/20	Stress	300	300	280	244	215	190	170	152	137	121
		Shear	183	169	157	146	137	129	122	116	110	103
L/360		◆◆◆	◆◆◆	◆◆◆	◆◆◆	136	114	96	81	70	58	
L/240		◆◆◆	◆◆◆	◆◆◆	◆◆◆	◆◆◆	◆◆◆	◆◆◆	◆◆◆	105	86	
L/180		◆◆◆	◆◆◆	◆◆◆	◆◆◆	◆◆◆	◆◆◆	◆◆◆	◆◆◆	◆◆◆	◆◆◆	
18/18	Stress	300	300	291	253	223	197	176	158	143	125	
	Shear	206	190	176	165	154	145	137	130	123	116	
	L/360	◆◆◆	◆◆◆	◆◆◆	◆◆◆	147	122	103	88	75	62	
	L/240	◆◆◆	◆◆◆	◆◆◆	◆◆◆	◆◆◆	◆◆◆	◆◆◆	◆◆◆	113	93	
	L/180	◆◆◆	◆◆◆	◆◆◆	◆◆◆	◆◆◆	◆◆◆	◆◆◆	◆◆◆	◆◆◆	◆◆◆	
18/16	Stress	300	300	299	261	229	203	181	162	147	129	
	Shear	179	166	154	144	135	127	120	113	108	101	
	L/360	◆◆◆	◆◆◆	◆◆◆	◆◆◆	◆◆◆	◆◆◆	109	93	80	65	
	L/240	◆◆◆	◆◆◆	◆◆◆	◆◆◆	◆◆◆	◆◆◆	◆◆◆	◆◆◆	◆◆◆	98	
	L/180	◆◆◆	◆◆◆	◆◆◆	◆◆◆	◆◆◆	◆◆◆	◆◆◆	◆◆◆	◆◆◆	◆◆◆	
16/18	Stress	300	300	300	300	274	243	217	194	175	154	
	Shear	241	222	206	192	180	170	160	152	144	135	
	L/360	◆◆◆	◆◆◆	◆◆◆	◆◆◆	175	146	123	105	90	74	
	L/240	◆◆◆	◆◆◆	◆◆◆	◆◆◆	◆◆◆	◆◆◆	◆◆◆	◆◆◆	134	111	
	L/180	◆◆◆	◆◆◆	◆◆◆	◆◆◆	◆◆◆	◆◆◆	◆◆◆	◆◆◆	◆◆◆	◆◆◆	
16/16	Stress	300	300	300	300	282	250	223	200	181	159	
	Shear	264	243	226	211	198	186	176	167	158	148	
	L/360	◆◆◆	◆◆◆	◆◆◆	◆◆◆	186	155	130	111	95	78	
	L/240	◆◆◆	◆◆◆	◆◆◆	◆◆◆	◆◆◆	◆◆◆	◆◆◆	◆◆◆	166	143	
	L/180	◆◆◆	◆◆◆	◆◆◆	◆◆◆	◆◆◆	◆◆◆	◆◆◆	◆◆◆	◆◆◆	◆◆◆	

See footnotes on page 115.

PLW3™-CD or W3CD FORMLOK™

■ Without Concrete Fill

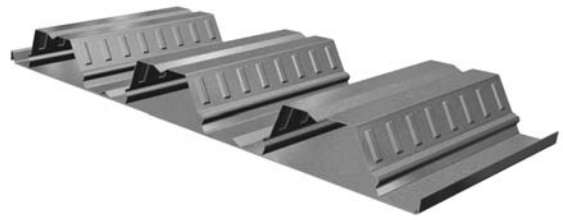

Allowable Uniform Loads (psf)

SPAN	DECK GAGE	CRITERIA	SPAN (ft-in.)															
			6'-0"	6'-6"	7'-0"	7'-6"	8'-0"	8'-6"	9'-0"	9'-6"	10'-0"	10'-8"	11'-0"	12'-0"	13'-0"	14'-0"	15'-0"	16'-0"
SINGLE	20/20	Stress	300	257	221	193	169	150	134	120	108	95	90	75	64	55	48	42
		Shear	190	176	163	152	143	134	127	120	114	107	104	95	88	82	76	71
		L/360	♦♦♦	♦♦♦	♦♦♦	151	124	104	87	74	64	52	48	37	29	23	19	16
		L/240	♦♦♦	♦♦♦	♦♦♦	♦♦♦	♦♦♦	♦♦♦	♦♦♦	111	96	79	72	55	44	35	28	23
		L/180	♦♦♦	♦♦♦	♦♦♦	♦♦♦	♦♦♦	♦♦♦	♦♦♦	♦♦♦	♦♦♦	♦♦♦	♦♦♦	74	58	46	38	31
	20/18	Stress	300	256	221	192	169	150	134	120	108	95	89	75	64	55	48	42
		Shear	176	162	151	141	132	124	117	111	106	99	96	88	81	75	70	66
		L/360	♦♦♦	♦♦♦	♦♦♦	♦♦♦	♦♦♦	111	93	79	68	56	51	39	31	25	20	17
		L/240	♦♦♦	♦♦♦	♦♦♦	♦♦♦	♦♦♦	♦♦♦	♦♦♦	♦♦♦	102	84	77	59	46	37	30	25
		L/180	♦♦♦	♦♦♦	♦♦♦	♦♦♦	♦♦♦	♦♦♦	♦♦♦	♦♦♦	♦♦♦	♦♦♦	♦♦♦	♦♦♦	62	50	40	33
	18/20	Stress	300	300	300	300	266	236	210	189	170	150	141	118	101	87	76	67
		Shear	210	194	180	168	157	148	140	132	126	118	114	105	97	90	84	79
		L/360	♦♦♦	♦♦♦	♦♦♦	♦♦♦	155	129	109	93	79	65	60	46	36	29	24	19
		L/240	♦♦♦	♦♦♦	♦♦♦	♦♦♦	♦♦♦	♦♦♦	♦♦♦	♦♦♦	119	98	89	69	54	43	35	29
		L/180	♦♦♦	♦♦♦	♦♦♦	♦♦♦	♦♦♦	♦♦♦	♦♦♦	♦♦♦	♦♦♦	♦♦♦	♦♦♦	92	72	58	47	39
	18/18	Stress	300	300	300	300	269	239	213	191	172	151	142	120	102	88	77	67
		Shear	290	267	248	232	217	204	193	183	174	163	158	145	134	124	116	109
		L/360	♦♦♦	♦♦♦	♦♦♦	202	167	139	117	100	85	70	64	49	39	31	25	21
		L/240	♦♦♦	♦♦♦	♦♦♦	♦♦♦	♦♦♦	♦♦♦	176	149	128	105	96	74	58	47	38	31
		L/180	♦♦♦	♦♦♦	♦♦♦	♦♦♦	♦♦♦	♦♦♦	♦♦♦	♦♦♦	171	140	128	99	78	62	51	42
18/16	Stress	300	300	300	300	268	238	212	190	172	151	142	119	102	88	76	67	
	Shear	272	251	233	218	204	192	181	172	163	153	148	136	125	117	109	102	
	L/360	♦♦♦	♦♦♦	♦♦♦	214	176	147	124	105	90	74	68	52	41	33	27	22	
	L/240	♦♦♦	♦♦♦	♦♦♦	♦♦♦	♦♦♦	♦♦♦	♦♦♦	158	135	111	102	78	62	49	40	33	
	L/180	♦♦♦	♦♦♦	♦♦♦	♦♦♦	♦♦♦	♦♦♦	♦♦♦	♦♦♦	♦♦♦	149	136	104	82	66	53	44	
16/18	Stress	300	300	300	300	300	300	273	245	221	194	183	153	131	113	98	86	
	Shear	300	287	267	249	234	220	208	197	187	175	170	156	144	133	125	117	
	L/360	♦♦♦	♦♦♦	♦♦♦	240	198	165	139	118	101	83	76	59	46	37	30	25	
	L/240	♦♦♦	♦♦♦	♦♦♦	♦♦♦	♦♦♦	♦♦♦	♦♦♦	177	152	125	114	88	69	55	45	37	
	L/180	♦♦♦	♦♦♦	♦♦♦	♦♦♦	♦♦♦	♦♦♦	♦♦♦	♦♦♦	♦♦♦	167	152	117	92	74	60	49	
16/16	Stress	300	300	300	300	300	300	277	249	225	197	186	156	133	115	100	88	
	Shear	300	300	300	300	300	284	268	254	241	226	219	201	186	172	161	151	
	L/360	♦♦♦	♦♦♦	♦♦♦	254	210	175	147	125	107	88	81	62	49	39	32	26	
	L/240	♦♦♦	♦♦♦	♦♦♦	♦♦♦	♦♦♦	262	221	188	161	133	121	93	73	59	48	39	
	L/180	♦♦♦	♦♦♦	♦♦♦	♦♦♦	♦♦♦	♦♦♦	♦♦♦	♦♦♦	215	177	161	124	98	78	64	52	

See footnotes on page 115.

PLW3™-CD or W3CD FORMLOK™

Without Concrete Fill

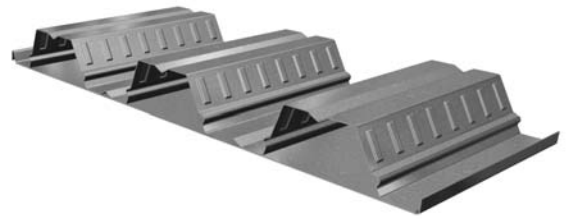

Allowable Uniform Loads (psf)

SPAN	DECK GAGE	CRITERIA	SPAN (ft-in.)																
			6'-0"	6'-6"	7'-0"	7'-6"	8'-0"	8'-6"	9'-0"	9'-6"	10'-0"	10'-8"	11'-0"	12'-0"	13'-0"	14'-0"	15'-0"	16'-0"	
DOUBLE	20/20	Stress	300	296	255	222	195	173	154	138	125	110	103	87	74	64	56	49	
		Shear	243	224	208	194	182	171	162	153	146	137	133	121	112	104	97	91	
		L/360	***	***	***	***	***	***	***	***	***	***	***	***	***	70	56	45	37
		L/240	***	***	***	***	***	***	***	***	***	***	***	***	***	***	***	***	***
		L/180	***	***	***	***	***	***	***	***	***	***	***	***	***	***	***	***	***
	20/18	Stress	300	300	266	232	204	181	161	145	130	115	108	91	77	67	58	51	
		Shear	164	152	141	132	123	116	110	104	99	92	90	82	76	70	66	62	
		L/360	***	***	***	***	***	***	***	***	***	***	***	***	75	60	49	40	
		L/240	***	***	***	***	***	***	***	***	***	***	***	***	***	***	***	***	
		L/180	***	***	***	***	***	***	***	***	***	***	***	***	***	***	***	***	
	18/20	Stress	300	300	300	289	254	225	201	180	163	143	134	113	96	83	72	63	
		Shear	280	258	240	224	210	197	186	177	168	157	152	140	129	120	112	105	
		L/360	***	***	***	***	***	***	***	***	***	***	***	111	87	70	57	47	
		L/240	***	***	***	***	***	***	***	***	***	***	***	***	***	***	***	***	
		L/180	***	***	***	***	***	***	***	***	***	***	***	***	***	***	***	***	
	18/18	Stress	300	300	300	300	264	234	209	187	169	149	140	118	100	86	75	66	
		Shear	300	282	262	244	229	215	203	193	183	172	166	153	141	131	122	114	
		L/360	***	***	***	***	***	***	***	***	***	***	***	***	93	75	61	50	
		L/240	***	***	***	***	***	***	***	***	***	***	***	***	***	***	***	***	
		L/180	***	***	***	***	***	***	***	***	***	***	***	***	***	***	***	***	
18/16	Stress	300	300	300	300	273	242	216	194	175	154	145	121	103	89	78	68		
	Shear	255	235	218	204	191	180	170	161	153	143	139	127	118	109	102	96		
	L/360	***	***	***	***	***	***	***	***	***	***	***	***	99	79	64	53		
	L/240	***	***	***	***	***	***	***	***	***	***	***	***	***	***	***	***		
	L/180	***	***	***	***	***	***	***	***	***	***	***	***	***	***	***	***		
16/18	Stress	300	300	300	300	300	287	256	230	207	182	171	144	123	106	92	81		
	Shear	300	300	300	289	271	255	241	228	217	203	197	181	167	155	144	135		
	L/360	***	***	***	***	***	***	***	***	***	***	***	141	111	89	72	60		
	L/240	***	***	***	***	***	***	***	***	***	***	***	***	***	***	***	***		
	L/180	***	***	***	***	***	***	***	***	***	***	***	***	***	***	***	***		
16/16	Stress	300	300	300	300	300	297	265	238	215	188	177	149	127	109	95	84		
	Shear	300	300	300	300	281	265	250	237	225	211	205	187	173	161	150	141		
	L/360	***	***	***	***	***	***	***	***	***	***	***	***	118	94	77	63		
	L/240	***	***	***	***	***	***	***	***	***	***	***	***	***	***	***	***		
	L/180	***	***	***	***	***	***	***	***	***	***	***	***	***	***	***	***		

See footnotes on page 115.

PLW3™-CD or W3CD FORMLOK™

■ Without Concrete Fill

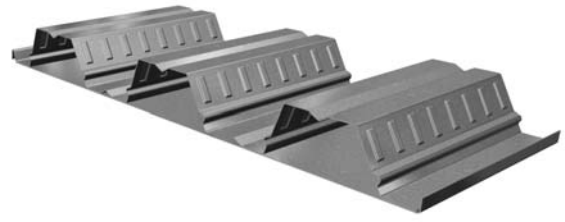

Allowable Uniform Loads (psf)

SPAN	DECK GAGE	CRITERIA	SPAN (ft-in.)										
			6'-0"	6'-6"	7'-0"	7'-6"	8'-0"	8'-6"	9'-0"	9'-6"	10'-0"	10'-8"	
TRIPLE	20/20	Stress	300	300	300	278	244	216	193	173	156	137	
		Shear	238	220	204	190	178	168	159	150	143	134	
		L/360	♦♦♦	♦♦♦	♦♦♦	♦♦♦	♦♦♦	♦♦♦	♦♦♦	♦♦♦	140	120	99
		L/240	♦♦♦	♦♦♦	♦♦♦	♦♦♦	♦♦♦	♦♦♦	♦♦♦	♦♦♦	♦♦♦	♦♦♦	♦♦♦
		L/180	♦♦♦	♦♦♦	♦♦♦	♦♦♦	♦♦♦	♦♦♦	♦♦♦	♦♦♦	♦♦♦	♦♦♦	♦♦♦
	20/18	Stress	300	300	300	290	255	226	201	181	163	143	
		Shear	171	158	147	137	128	121	114	108	103	96	
		L/360	♦♦♦	♦♦♦	♦♦♦	♦♦♦	♦♦♦	♦♦♦	♦♦♦	♦♦♦	♦♦♦	♦♦♦	
		L/240	♦♦♦	♦♦♦	♦♦♦	♦♦♦	♦♦♦	♦♦♦	♦♦♦	♦♦♦	♦♦♦	♦♦♦	
		L/180	♦♦♦	♦♦♦	♦♦♦	♦♦♦	♦♦♦	♦♦♦	♦♦♦	♦♦♦	♦♦♦	♦♦♦	
	18/20	Stress	300	300	300	300	300	281	251	225	203	178	
		Shear	262	242	225	210	197	185	175	166	157	147	
L/360		♦♦♦	♦♦♦	♦♦♦	♦♦♦	♦♦♦	♦♦♦	♦♦♦	♦♦♦	♦♦♦	150	123	
L/240		♦♦♦	♦♦♦	♦♦♦	♦♦♦	♦♦♦	♦♦♦	♦♦♦	♦♦♦	♦♦♦	♦♦♦	♦♦♦	
L/180		♦♦♦	♦♦♦	♦♦♦	♦♦♦	♦♦♦	♦♦♦	♦♦♦	♦♦♦	♦♦♦	♦♦♦	♦♦♦	
18/18	Stress	300	300	300	300	300	293	261	234	212	186		
	Shear	300	293	272	254	238	224	212	201	191	179		
	L/360	♦♦♦	♦♦♦	♦♦♦	♦♦♦	♦♦♦	♦♦♦	♦♦♦	♦♦♦	188	161	132	
	L/240	♦♦♦	♦♦♦	♦♦♦	♦♦♦	♦♦♦	♦♦♦	♦♦♦	♦♦♦	♦♦♦	♦♦♦	♦♦♦	
	L/180	♦♦♦	♦♦♦	♦♦♦	♦♦♦	♦♦♦	♦♦♦	♦♦♦	♦♦♦	♦♦♦	♦♦♦	♦♦♦	
18/16	Stress	300	300	300	300	300	300	270	242	219	192		
	Shear	265	245	228	212	199	187	177	168	159	149		
	L/360	♦♦♦	♦♦♦	♦♦♦	♦♦♦	♦♦♦	♦♦♦	♦♦♦	♦♦♦	♦♦♦	♦♦♦	140	
	L/240	♦♦♦	♦♦♦	♦♦♦	♦♦♦	♦♦♦	♦♦♦	♦♦♦	♦♦♦	♦♦♦	♦♦♦	♦♦♦	
	L/180	♦♦♦	♦♦♦	♦♦♦	♦♦♦	♦♦♦	♦♦♦	♦♦♦	♦♦♦	♦♦♦	♦♦♦	♦♦♦	
16/18	Stress	300	300	300	300	300	300	300	287	259	228		
	Shear	300	300	300	300	282	266	251	238	226	212		
	L/360	♦♦♦	♦♦♦	♦♦♦	♦♦♦	♦♦♦	♦♦♦	♦♦♦	♦♦♦	223	191	157	
	L/240	♦♦♦	♦♦♦	♦♦♦	♦♦♦	♦♦♦	♦♦♦	♦♦♦	♦♦♦	♦♦♦	♦♦♦	♦♦♦	
	L/180	♦♦♦	♦♦♦	♦♦♦	♦♦♦	♦♦♦	♦♦♦	♦♦♦	♦♦♦	♦♦♦	♦♦♦	♦♦♦	
16/16	Stress	300	300	300	300	300	300	300	297	268	236		
	Shear	300	300	300	300	293	276	260	247	234	220		
	L/360	♦♦♦	♦♦♦	♦♦♦	♦♦♦	♦♦♦	♦♦♦	♦♦♦	♦♦♦	236	202	167	
	L/240	♦♦♦	♦♦♦	♦♦♦	♦♦♦	♦♦♦	♦♦♦	♦♦♦	♦♦♦	♦♦♦	♦♦♦	♦♦♦	
	L/180	♦♦♦	♦♦♦	♦♦♦	♦♦♦	♦♦♦	♦♦♦	♦♦♦	♦♦♦	♦♦♦	♦♦♦	♦♦♦	

See footnotes on page 115.



9/16" Shallow VERCOR™ Deck

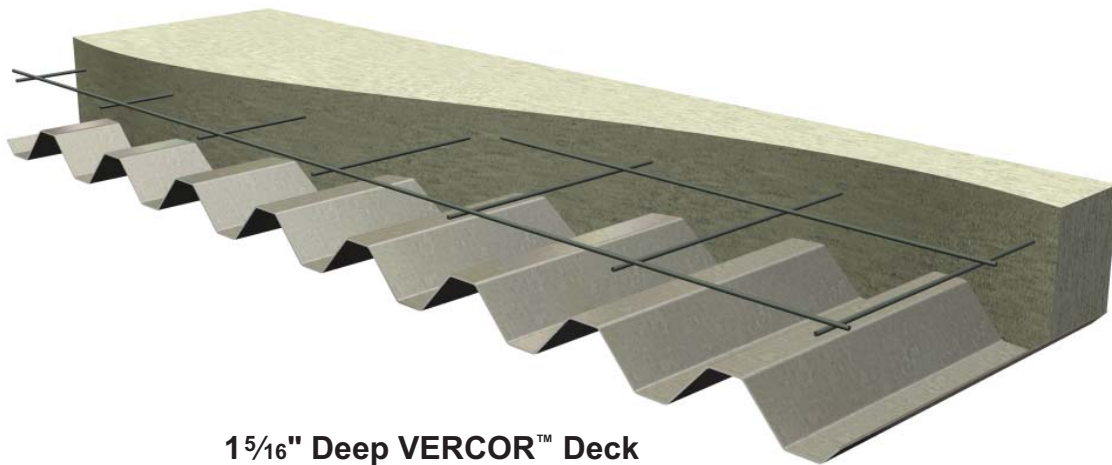

1 5/16" Deep VERCOR™ Deck

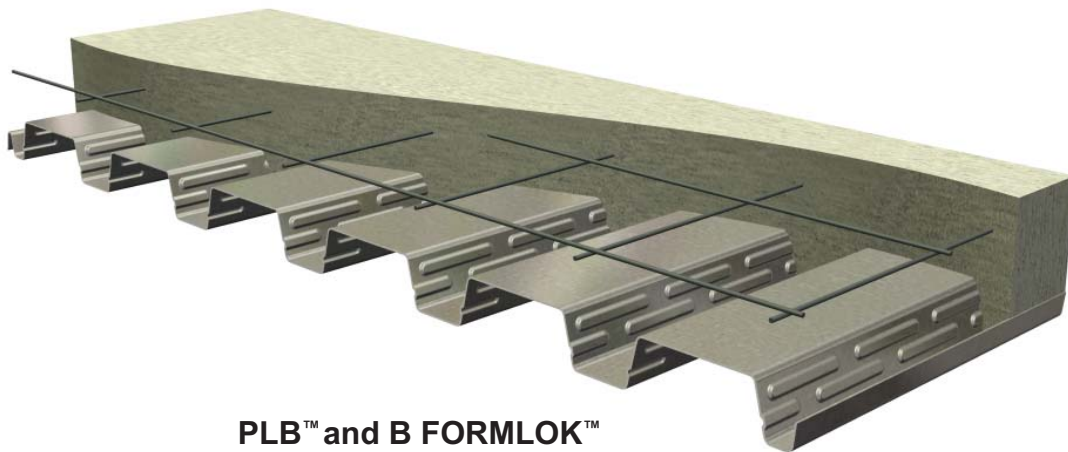

PLB™ and B FORMLOK™

SHALLOW & DEEP VERCOR, PLB & B FORMLOK CONTENTS

Section Properties	128-130
Allowable Uniform Load Tables	131-133
Shallow VERCOR™ Diaphragm Tables	134-135
Deep VERCOR™ Diaphragm Tables	136-137
PLB™ and B FORMLOK™ Diaphragm Tables	138-139

Shallow VERCOR™

- 9/16" Deep Deck
- Galvanized

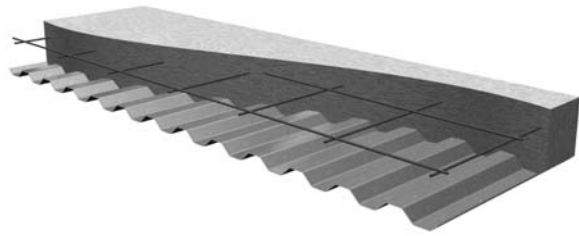

Dimensions

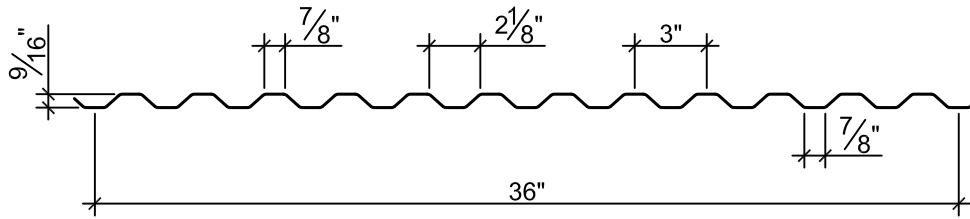

Deck Weight and Section Properties

Gage	Weight		I_d for Deflection		Moment		Allowable Reactions per ft of Width (lb) due to Web Crippling						
	Galv (psf)	Single Span (in. ⁴ /ft)	Multi Span (in. ⁴ /ft)	+ S_{eff} (in. ³ /ft)	- S_{eff} (in. ³ /ft)	One Flange Loading				Two Flange Loading			
						End Bearing Length		Interior Bearing Length		End Bearing Length		Interior Bearing Length	
						1 1/2"	2"	1 1/2"	2"	1 1/2"	2"	1 1/2"	2"
26	1.0	0.013	0.013	0.041	0.043	581	644	788	862	536	582	963	1061
24	1.3	0.018	0.018	0.059	0.059	980	1081	1375	1497	999	1080	1709	1875
22	1.6	0.022	0.022	0.073	0.073	1466	1611	2105	2283	1598	1721	2645	2889

- Notes:**
1. Section properties are based on $F_y = 60,000$ psi (specified minimum $F_y = 80,000$ psi).
 2. I_d is for deflection due to uniform loads.
 3. S_{eff} (+ or -) is the effective section modulus.
 4. Allowable (ASD) reactions are based on web crippling, per AISI S100 Section C3.4, where $\Omega_w = 1.70$ for end bearing and 1.75 for interior bearing. Nominal reactions may be determined by multiplying the table values by Ω_w . LRFD reactions may be determined by multiplying nominal reactions by $\phi_w = 0.9$ for end reactions and 0.85 for interior reactions.

Attachment Patterns to Supports

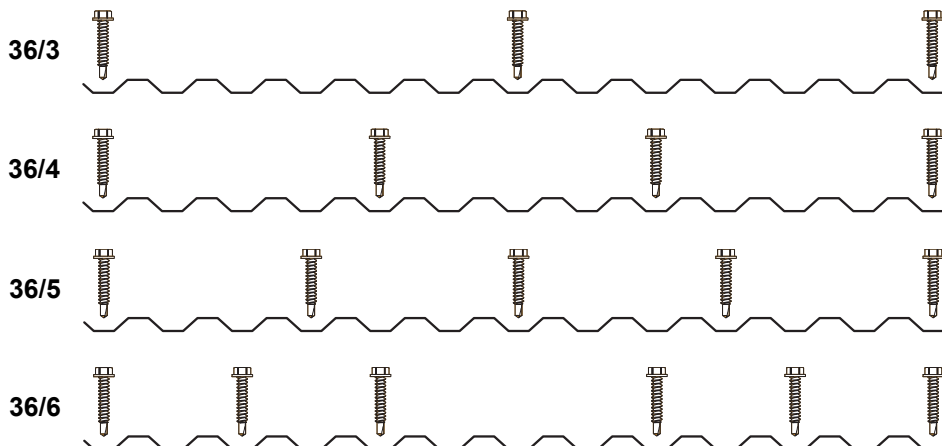

Deep VERCOR™

- 15/16" Deep Deck
- Galvanized

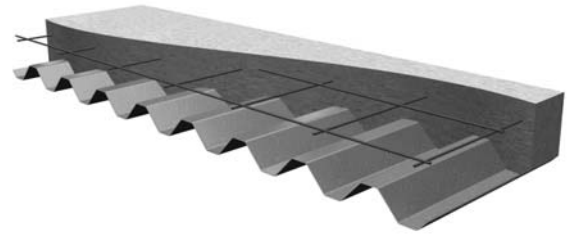

Dimensions

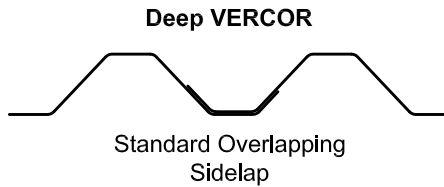
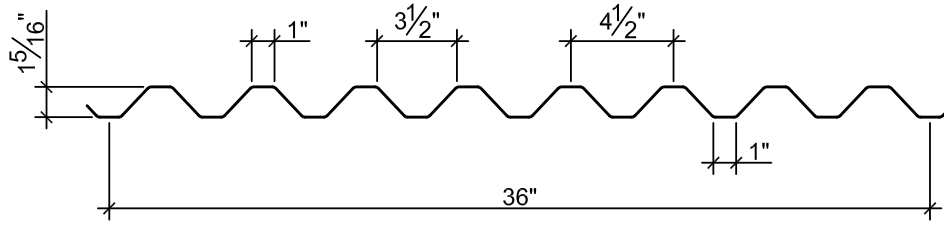

Deck Weight and Section Properties

Gage	Weight Galv (psf)	I_d for Deflection		Moment		Allowable Reactions per ft of Width (lb) due to Web Crippling One Flange Loading									
		Single Span (in.4/ft)	Multi Span (in.4/ft)	+ S_{eff} (in.3/ft)	- S_{eff} (in.3/ft)	End Bearing Length			Interior Bearing Length		End Bearing Length			Interior Bearing Length	
						2"	3"	4"	3"	4"	2"	3"	4"	3"	4"
26	1.1	0.075	0.075	0.099	0.103	492	572	639	829	916	421	477	524	973	1082
24	1.4	0.097	0.097	0.137	0.138	802	927	1032	1366	1503	762	857	937	1642	1819
22	1.7	0.120	0.120	0.172	0.171	1184	1361	1510	2029	2225	1208	1351	1472	2479	2737
20	2.1	0.143	0.143	0.204	0.204	1628	1864	2064	2807	3069	1751	1950	2118	3467	3817

Notes:

1. Section properties are based on $F_y = 60,000$ psi (specified minimum $F_y = 80,000$ psi).
2. I_d is for deflection due to uniform loads.
3. S_{eff} (+ or -) is the effective section modulus.
4. Allowable (ASD) reactions are based on web crippling, per AISI S100 Section C3.4, where $\Omega_w = 1.70$ for end bearing and 1.75 for interior bearing. Nominal reactions may be determined by multiplying the table values by Ω_w . LRFD reactions may be determined by multiplying nominal reactions by $\phi_w = 0.9$ for end reactions and 0.85 for interior reactions.

Attachment Patterns to Supports

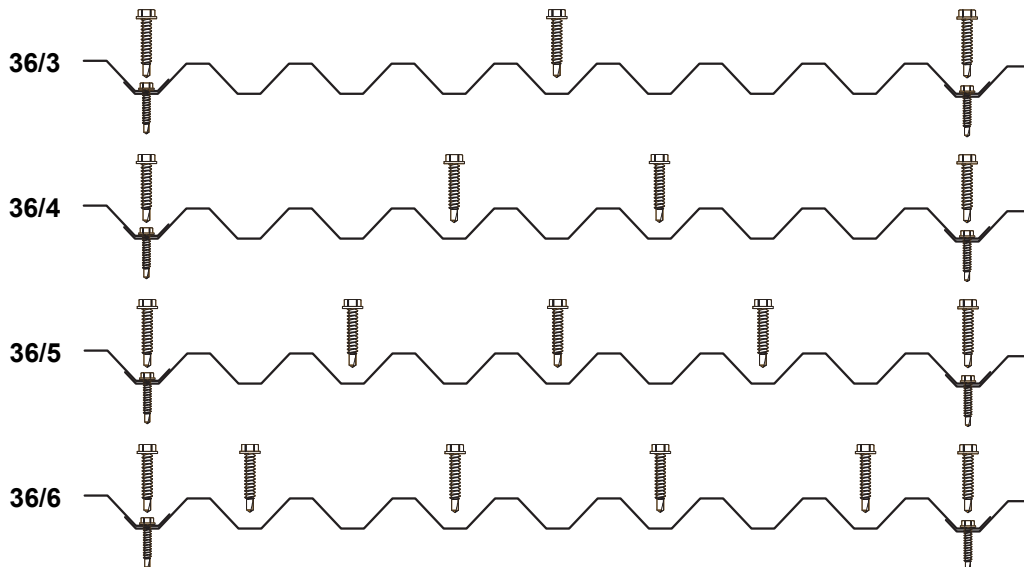

PLB™ or B FORMLOK™

- 1½" Deep Deck
- Primer Painted or Galvanized

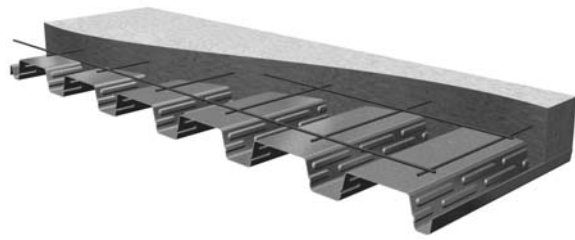

Dimensions

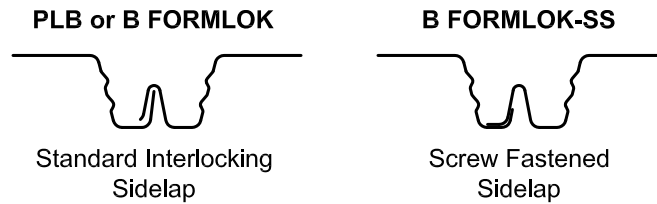
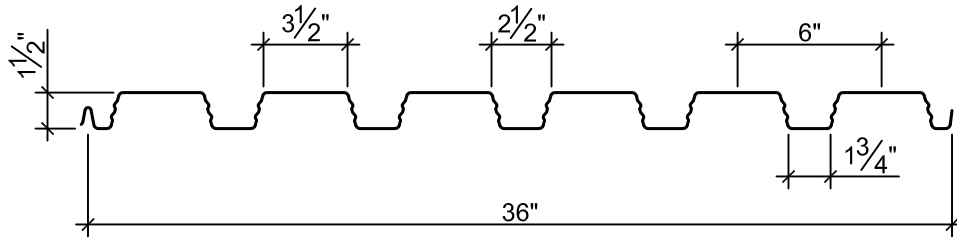

Deck Weight and Section Properties

Gage	Weight		I_d for Deflection		Moment		Allowable Reactions per ft of Width (lb) due to Web Crippling									
	Galv (psf)	Painted (psf)	Single Span (in. ⁴ /ft)	Multi Span (in. ⁴ /ft)	+ S_{eff} (in. ³ /ft)	- S_{eff} (in. ³ /ft)	One Flange Loading				Two Flange Loading					
							End Bearing Length		Interior Bearing Length		End Bearing Length		Interior Bearing Length			
							2"	3"	4"	3"	4"	2"	3"	4"	3"	4"
22	1.9	1.8	0.177	0.192	0.176	0.188	935	1076	1163	1559	1671	962	1078	1150	1935	2084
20	2.3	2.2	0.219	0.231	0.230	0.237	1301	1492	1609	2190	2340	1413	1576	1675	2744	2947
18	2.9	2.8	0.302	0.306	0.314	0.331	2181	2484	2667	3714	3950	2551	2823	2987	4713	5038
16	3.5	3.4	0.381	0.381	0.399	0.410	3265	3699	3955	5607	5938	4018	4422	4660	7168	7631

- Notes:**
1. Section properties are based on $F_y = 50,000$ psi.
 2. I_d is for deflection due to uniform loads.
 3. S_{eff} (+ or -) is the effective section modulus.
 4. Allowable (ASD) reactions are based on web crippling, per AISI S100 Section C3.4, where $\Omega_w = 1.70$ for end bearing and 1.75 for interior bearing. Nominal reactions may be determined by multiplying the table values by Ω_w . LRFD reactions may be determined by multiplying nominal reactions by $\Phi_w = 0.90$ for end reactions and 0.85 for interior reactions.

Attachment Patterns to Supports

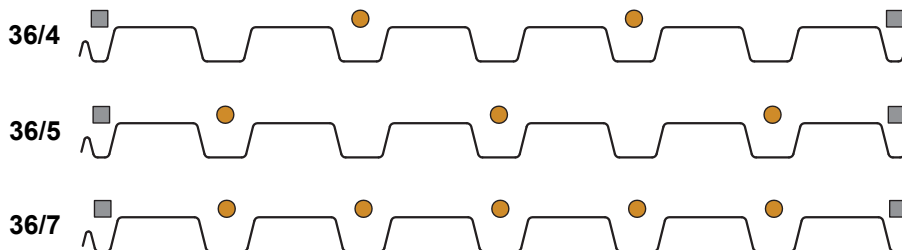



Allowable Uniform Loads (psf)

Span	Deck Gage	Criteria	Span (ft-in.)										
			1'-0"	1'-6"	2'-0"	2'-6"	3'-0"	3'-6"	4'-0"	4'-6"	5'-0"	5'-6"	6'-0"
SINGLE	26	Stress	300	300	246	157	109	80	62	49	39	33	27
		L/360	◆◆◆	169	71	36	21	13	9	6	5	3	3
		L/240	◆◆◆	253	107	55	32	20	13	9	7	5	4
		L/180	◆◆◆	◆◆◆	142	73	42	27	18	12	9	7	5
	24	Stress	300	300	300	227	157	116	89	70	57	47	39
		L/360	◆◆◆	233	98	50	29	18	12	9	6	5	4
		L/240	◆◆◆	◆◆◆	148	76	44	28	18	13	9	7	5
		L/180	◆◆◆	◆◆◆	197	101	58	37	25	17	13	9	7
	22	Stress	300	300	300	280	195	143	110	87	70	58	49
		L/360	◆◆◆	285	120	62	36	22	15	11	8	6	4
		L/240	◆◆◆	◆◆◆	181	92	54	34	23	16	12	9	7
		L/180	◆◆◆	◆◆◆	241	123	71	45	30	21	15	12	9
DOUBLE	26	Stress	300	300	258	165	115	84	65	51	41	34	29
		L/360	◆◆◆	◆◆◆	171	88	51	32	21	15	11	8	6
		L/240	◆◆◆	◆◆◆	257	132	76	48	32	23	16	12	10
		L/180	◆◆◆	◆◆◆	◆◆◆	◆◆◆	101	64	43	30	22	16	13
	24	Stress	300	300	300	227	157	116	89	70	57	47	39
		L/360	◆◆◆	◆◆◆	237	121	70	44	30	21	15	11	9
		L/240	◆◆◆	◆◆◆	◆◆◆	182	105	66	44	31	23	17	13
		L/180	◆◆◆	◆◆◆	◆◆◆	◆◆◆	141	88	59	42	30	23	18
	22	Stress	300	300	300	280	195	143	110	87	70	58	49
		L/360	◆◆◆	◆◆◆	290	148	86	54	36	25	19	14	11
		L/240	◆◆◆	◆◆◆	◆◆◆	223	129	81	54	38	28	21	16
		L/180	◆◆◆	◆◆◆	◆◆◆	◆◆◆	172	108	72	51	37	28	21
TRIPLE	26	Stress	300	300	300	206	143	105	81	64	52	43	36
		L/360	◆◆◆	◆◆◆	134	69	40	25	17	12	9	6	5
		L/240	◆◆◆	◆◆◆	201	103	60	38	25	18	13	10	7
		L/180	◆◆◆	◆◆◆	268	137	79	50	34	24	17	13	10
	24	Stress	300	300	300	283	197	144	111	87	71	59	49
		L/360	◆◆◆	◆◆◆	186	95	55	35	23	16	12	9	7
		L/240	◆◆◆	◆◆◆	278	143	82	52	35	24	18	13	10
		L/180	◆◆◆	◆◆◆	◆◆◆	190	110	69	46	33	24	18	14
	22	Stress	300	300	300	300	243	179	137	108	88	72	61
		L/360	◆◆◆	◆◆◆	227	116	67	42	28	20	15	11	8
		L/240	◆◆◆	◆◆◆	◆◆◆	174	101	63	43	30	22	16	13
		L/180	◆◆◆	◆◆◆	◆◆◆	232	134	85	57	40	29	22	17

1. Stress = Allowable uniform load based on maximum allowable flexural stress in deck.
2. L/360, L/240 or L/180 = Uniform load which produces selected deflection in deck.
3. The symbol ◆◆◆ indicates allowable uniform load based on deflection exceeds allowable uniform load based on stress.
4. Nominal uniform loads based on flexure stress may be determined by multiplying the allowable uniform loads in the table by $\Omega_b = 1.67$. LRFD uniform loads may be determined by multiplying nominal uniform loads by $\phi_b = 0.95$.
5. Allowable superimposed load for concrete filled Vercor deck is bare deck capacity minus dead load of concrete plus design applied dead and live load.



Allowable Uniform Loads (psf)

Span	Deck Gage	Criteria	Span (ft.-in.)														
			3'-0"	3'-6"	4'-0"	4'-6"	5'-0"	5'-6"	6'-0"	6'-6"	7'-0"	7'-6"	8'-0"	8'-6"	9'-0"	9'-6"	10'-0"
SINGLE	26	Stress	264	194	149	117	95	79	66	56	48	42	37	33	29	26	24
		L/360	122	77	51	36	26	20	15	12	10	8	6	5	5	4	3
		L/240	182	115	77	54	39	30	23	18	14	12	10	8	7	6	5
		L/180	243	153	103	72	53	39	30	24	19	16	13	11	9	8	7
	24	Stress	300	268	206	162	132	109	91	78	67	58	51	46	41	36	33
		L/360	157	99	66	47	34	26	20	15	12	10	8	7	6	5	4
		L/240	236	149	100	70	51	38	29	23	19	15	12	10	9	7	6
		L/180	◆◆◆	198	133	93	68	51	39	31	25	20	17	14	12	10	8
	22	Stress	300	300	258	204	165	136	115	98	84	73	65	57	51	46	41
		L/360	195	123	82	58	42	32	24	19	15	12	10	9	7	6	5
		L/240	292	184	123	86	63	47	36	29	23	19	15	13	11	9	8
		L/180	◆◆◆	245	164	115	84	63	49	38	31	25	21	17	14	12	11
20	Stress	300	300	300	242	196	162	136	116	100	87	77	68	60	54	49	
	L/360	232	146	98	69	50	38	29	23	18	15	12	10	9	7	6	
	L/240	◆◆◆	219	147	103	75	56	43	34	27	22	18	15	13	11	9	
	L/180	◆◆◆	292	196	137	100	75	58	46	36	30	24	20	17	15	13	
DOUBLE	26	Stress	275	202	155	122	99	82	69	59	50	44	39	34	31	27	25
		L/360	◆◆◆	184	123	87	63	48	37	29	23	19	15	13	11	9	8
		L/240	◆◆◆	◆◆◆	◆◆◆	◆◆◆	95	71	55	43	35	28	23	19	16	14	12
		L/180	◆◆◆	◆◆◆	◆◆◆	◆◆◆	◆◆◆	◆◆◆	◆◆◆	58	46	37	31	26	22	18	16
	24	Stress	300	270	207	164	132	109	92	78	68	59	52	46	41	37	33
		L/360	◆◆◆	238	160	112	82	61	47	37	30	24	20	17	14	12	10
		L/240	◆◆◆	◆◆◆	◆◆◆	◆◆◆	123	92	71	56	45	36	30	25	21	18	15
		L/180	◆◆◆	◆◆◆	◆◆◆	◆◆◆	◆◆◆	◆◆◆	◆◆◆	74	60	48	40	33	28	24	20
	22	Stress	300	300	257	203	164	136	114	97	84	73	64	57	51	45	41
		L/360	◆◆◆	295	198	139	101	76	59	46	37	30	25	21	17	15	13
		L/240	◆◆◆	◆◆◆	◆◆◆	◆◆◆	152	114	88	69	55	45	37	31	26	22	19
		L/180	◆◆◆	◆◆◆	◆◆◆	◆◆◆	◆◆◆	◆◆◆	◆◆◆	92	74	60	49	41	35	29	25
20	Stress	300	300	300	242	196	162	136	116	100	87	77	68	60	54	49	
	L/360	◆◆◆	◆◆◆	235	165	121	91	70	55	44	36	29	25	21	18	15	
	L/240	◆◆◆	◆◆◆	◆◆◆	◆◆◆	181	136	105	82	66	54	44	37	31	26	23	
	L/180	◆◆◆	◆◆◆	◆◆◆	◆◆◆	◆◆◆	◆◆◆	◆◆◆	110	88	71	59	49	41	35	30	
TRIPLE	26	Stress	300	252	193	153	124	102	86	73	63	55	48	43	38	34	31
		L/360	229	144	97	68	49	37	29	23	18	15	12	10	8	7	6
		L/240	◆◆◆	216	145	102	74	56	43	34	27	22	18	15	13	11	9
		L/180	◆◆◆	◆◆◆	◆◆◆	136	99	74	57	45	36	29	24	20	17	14	12
	24	Stress	300	300	259	204	166	137	115	98	84	74	65	57	51	46	41
		L/360	296	187	125	88	64	48	37	29	23	19	16	13	11	9	8
		L/240	◆◆◆	280	187	132	96	72	56	44	35	28	23	20	16	14	12
		L/180	◆◆◆	◆◆◆	250	176	128	96	74	58	47	38	31	26	22	19	16
	22	Stress	300	300	300	253	205	170	143	121	105	91	80	71	63	57	51
		L/360	◆◆◆	231	155	109	79	59	46	36	29	23	19	16	14	12	10
		L/240	◆◆◆	◆◆◆	232	163	119	89	69	54	43	35	29	24	20	17	15
		L/180	◆◆◆	◆◆◆	◆◆◆	217	158	119	92	72	58	47	39	32	27	23	20
20	Stress	300	300	300	300	245	202	170	145	125	109	96	85	76	68	61	
	L/360	◆◆◆	275	184	129	94	71	55	43	34	28	23	19	16	14	12	
	L/240	◆◆◆	◆◆◆	276	194	142	106	82	64	52	42	35	29	24	21	18	
	L/180	◆◆◆	◆◆◆	◆◆◆	259	189	142	109	86	69	56	46	38	32	28	24	

See footnotes on page 131.



Allowable Uniform Loads (psf)

Span	Deck Gage	Criteria	Span (ft.-in.)																
			2'-0"	3'-0"	4'-0"	5'-0"	5'-6"	6'-0"	6'-6"	7'-0"	7'-6"	8'-0"	8'-6"	9'-0"	9'-6"	10'-0"	11'-0"	12'-0"	
SINGLE	22	Stress	300	300	220	141	116	98	83	72	63	55	49	43	39	35	29	24	
		L/360	◆◆◆	287	121	62	47	36	28	23	18	15	13	11	9	8	6	4	
		L/240	◆◆◆	◆◆◆	182	93	70	54	42	34	28	23	19	16	14	12	9	7	
		L/180	◆◆◆	◆◆◆	◆◆◆	124	93	72	56	45	37	30	25	21	18	15	12	9	
	20	Stress	300	300	288	184	152	128	109	94	82	72	64	57	51	46	38	32	
		L/360	◆◆◆	◆◆◆	150	77	58	44	35	28	23	19	16	13	11	10	7	6	
		L/240	◆◆◆	◆◆◆	225	115	86	67	52	42	34	28	23	20	17	14	11	8	
		L/180	◆◆◆	◆◆◆	◆◆◆	153	115	89	70	56	45	37	31	26	22	19	14	11	
	18	Stress	300	300	300	251	208	174	149	128	112	98	87	78	70	63	52	44	
		L/360	◆◆◆	◆◆◆	207	106	79	61	48	39	31	26	22	18	15	13	10	8	
		L/240	◆◆◆	◆◆◆	◆◆◆	159	119	92	72	58	47	39	32	27	23	20	15	11	
		L/180	◆◆◆	◆◆◆	◆◆◆	212	159	122	96	77	63	52	43	36	31	26	20	15	
16	Stress	300	300	300	300	264	222	189	163	142	125	110	99	88	80	66	55		
	L/360	◆◆◆	◆◆◆	261	133	100	77	61	49	40	33	27	23	19	17	13	10		
	L/240	◆◆◆	◆◆◆	◆◆◆	200	150	116	91	73	59	49	41	34	29	25	19	14		
	L/180	◆◆◆	◆◆◆	◆◆◆	267	200	154	121	97	79	65	54	46	39	33	25	19		
DOUBLE	22	Stress	300	300	235	150	124	104	89	77	67	59	52	46	42	38	31	26	
		L/360	◆◆◆	◆◆◆	◆◆◆	◆◆◆	122	94	74	59	48	40	33	28	24	20	15	12	
		L/240	◆◆◆	◆◆◆	◆◆◆	◆◆◆	◆◆◆	◆◆◆	◆◆◆	◆◆◆	◆◆◆	◆◆◆	◆◆◆	49	42	35	30	23	18
		L/180	◆◆◆	◆◆◆	◆◆◆	◆◆◆	◆◆◆	◆◆◆	◆◆◆	◆◆◆	◆◆◆	◆◆◆	◆◆◆	◆◆◆	◆◆◆	◆◆◆	◆◆◆	30	23
	20	Stress	300	300	296	190	157	132	112	97	84	74	66	59	53	47	39	33	
		L/360	◆◆◆	◆◆◆	◆◆◆	◆◆◆	146	113	89	71	58	48	40	33	28	24	18	14	
		L/240	◆◆◆	◆◆◆	◆◆◆	◆◆◆	◆◆◆	◆◆◆	◆◆◆	◆◆◆	◆◆◆	71	59	50	43	37	27	21	
		L/180	◆◆◆	◆◆◆	◆◆◆	◆◆◆	◆◆◆	◆◆◆	◆◆◆	◆◆◆	◆◆◆	◆◆◆	◆◆◆	◆◆◆	◆◆◆	◆◆◆	◆◆◆	37	28
	18	Stress	300	300	300	265	219	184	157	135	118	103	92	82	73	66	55	46	
		L/360	◆◆◆	◆◆◆	◆◆◆	258	194	149	117	94	76	63	53	44	38	32	24	19	
		L/240	◆◆◆	◆◆◆	◆◆◆	◆◆◆	◆◆◆	◆◆◆	◆◆◆	◆◆◆	115	94	79	66	56	48	36	28	
		L/180	◆◆◆	◆◆◆	◆◆◆	◆◆◆	◆◆◆	◆◆◆	◆◆◆	◆◆◆	◆◆◆	◆◆◆	◆◆◆	◆◆◆	◆◆◆	◆◆◆	64	48	37
16	Stress	300	300	300	300	271	228	194	167	146	128	113	101	91	82	68	57		
	L/360	◆◆◆	◆◆◆	◆◆◆	◆◆◆	241	186	146	117	95	78	65	55	47	40	30	23		
	L/240	◆◆◆	◆◆◆	◆◆◆	◆◆◆	◆◆◆	◆◆◆	◆◆◆	◆◆◆	◆◆◆	143	118	98	83	70	60	45	35	
	L/180	◆◆◆	◆◆◆	◆◆◆	◆◆◆	◆◆◆	◆◆◆	◆◆◆	◆◆◆	◆◆◆	◆◆◆	◆◆◆	◆◆◆	◆◆◆	◆◆◆	80	60	46	
TRIPLE	22	Stress	300	300	294	188	155	131	111	96	84	73	65	58	52	47	39	33	
		L/360	◆◆◆	◆◆◆	247	127	95	73	58	46	38	31	26	22	18	16	12	9	
		L/240	◆◆◆	◆◆◆	◆◆◆	◆◆◆	143	110	86	69	56	46	39	33	28	24	18	14	
		L/180	◆◆◆	◆◆◆	◆◆◆	◆◆◆	◆◆◆	◆◆◆	◆◆◆	◆◆◆	92	75	62	52	43	37	32	24	18
	20	Stress	300	300	300	237	196	165	140	121	105	93	82	73	66	59	49	41	
		L/360	◆◆◆	◆◆◆	298	152	115	88	69	56	45	37	31	26	22	19	14	11	
		L/240	◆◆◆	◆◆◆	◆◆◆	229	172	132	104	83	68	56	47	39	33	29	21	17	
		L/180	◆◆◆	◆◆◆	◆◆◆	◆◆◆	◆◆◆	◆◆◆	139	111	90	74	62	52	44	38	29	22	
	18	Stress	300	300	300	300	274	230	196	169	147	129	115	102	92	83	68	57	
		L/360	◆◆◆	◆◆◆	◆◆◆	202	152	117	92	74	60	49	41	35	29	25	19	15	
		L/240	◆◆◆	◆◆◆	◆◆◆	◆◆◆	228	175	138	110	90	74	62	52	44	38	28	22	
		L/180	◆◆◆	◆◆◆	◆◆◆	◆◆◆	◆◆◆	◆◆◆	184	147	120	99	82	69	59	50	38	29	
16	Stress	300	300	300	300	300	285	243	209	182	160	142	127	114	103	85	71		
	L/360	◆◆◆	◆◆◆	◆◆◆	251	189	145	114	92	74	61	51	43	37	31	24	18		
	L/240	◆◆◆	◆◆◆	◆◆◆	◆◆◆	283	218	172	137	112	92	77	65	55	47	35	27		
	L/180	◆◆◆	◆◆◆	◆◆◆	◆◆◆	◆◆◆	◆◆◆	229	183	149	123	102	86	73	63	47	36		

See footnotes on page 131.

Shallow VERCOR™

- ≥ 3 in. Total Slab Depth
- Normal Weight Concrete

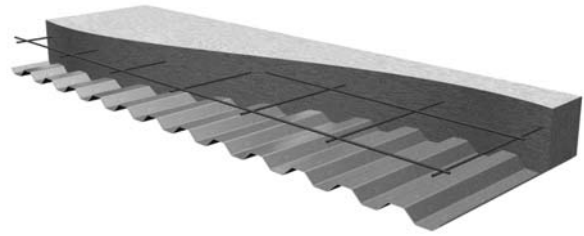

Allowable Interior Diaphragm Shear Strengths, q (plf) and Flexibility Factors, F (in./lb. x 10⁶)

Deck Gage	Total Slab Thickness	Attachment Pattern	Span (ft-in.)								
			2'-0"	2'-6"	3'-0"	3'-6"	4'-0"	4'-6"	5'-0"	5'-6"	6'-0"
26	3.0"	q - 3 screws	1629	1600	1582	1566	1559	1549	1541	1535	1529
		q - 4 screws	1642	1611	1591	1574	1566	1555	1547	1540	1534
		q - 5 screws	1658	1624	1603	1584	1575	1564	1554	1547	1541
		q - 6 screws	1694	1653	1628	1606	1595	1582	1571	1562	1554
	Thickness ≥ 3.5"	q - 3 screws	1931	1902	1884	1868	1860	1851	1843	1837	1831
		q - 3 screws	1691	1651	1625	1603	1592	1579	1568	1559	1552
		q - 4 screws	1708	1665	1637	1614	1602	1588	1576	1566	1558
		q - 5 screws	1730	1682	1653	1627	1614	1598	1586	1575	1567
24	3.0"	q - 6 screws	1777	1721	1687	1656	1641	1623	1607	1595	1585
		q - 3 screws	1993	1952	1927	1905	1894	1881	1870	1861	1854
		q - 4 screws	2010	1967	1939	1915	1904	1889	1878	1868	1860
		q - 5 screws	2032	1984	1955	1929	1916	1900	1888	1877	1868
	Thickness ≥ 4.0"	q - 6 screws	2079	2023	1988	1958	1943	1924	1909	1897	1887
		q - 3 screws	2295	2254	2229	2207	2196	2182	2172	2163	2155
		q - 3 screws	1756	1703	1670	1642	1627	1610	1596	1585	1575
		q - 4 screws	1777	1721	1685	1655	1640	1621	1606	1594	1584
22	3.0"	q - 5 screws	1804	1743	1705	1671	1655	1635	1618	1605	1594
		q - 6 screws	1863	1792	1747	1708	1689	1665	1645	1630	1616
		q - 3 screws	2057	2005	1972	1943	1929	1912	1898	1887	1877
		q - 4 screws	2079	2023	1987	1957	1941	1923	1908	1896	1885
	3.5"	q - 5 screws	2106	2045	2007	1973	1957	1936	1920	1907	1896
		q - 6 screws	2165	2094	2049	2009	1991	1967	1947	1931	1918
		q - 3 screws	2359	2307	2274	2245	2231	2214	2200	2188	2179
		q - 4 screws	2381	2325	2289	2258	2243	2225	2210	2197	2187
	4.0"	q - 5 screws	2408	2347	2308	2275	2259	2238	2222	2209	2197
		q - 6 screws	2467	2396	2351	2311	2293	2268	2249	2233	2220
		q - 3 screws	2661	2609	2576	2547	2533	2515	2502	2490	2481

See footnotes on page 135. See page 131 for vertical loads footnotes.

Shallow VERCOR™

- ≥ 3 in. Total Slab Depth
- Normal Weight Concrete

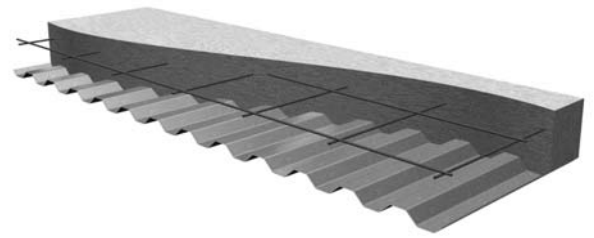

Concrete Properties

Density (pcf)	Uniform Weight (psf)	Uniform Volume (yd ³ /100 ft ²)	Compressive Strength, f' _c (psi)
145	32.9 to 69.1	0.839 to 1.852	3000

Notes:

1. Volumes and weights do not include allowance for deflection.
2. Weights are for concrete only and do not include weight of steel deck.
3. Total slab depth is nominal depth from top of concrete to bottom of steel deck.
4. Uniform and weight volume depend on slab thickness selected. See pages 20-21 for further information.

Footnotes for Maximum Unshored Clear Span and Allowable Diaphragm Shear Strength Tables

1. Interior connections may be #12, #14 or Shearflex® screws.
2. Connections at diaphragm perimeter or other collector elements are to be based on the actual shear to be transferred and the capacity of the connections used.

Allowable Shear Capacity per Connection (lbs)	Fastener Type	9/16" SV - Deck Gage		
		26	24	22
	#12 Screw	199 lbs	266 lbs	333 lbs
	#14 Screw or Shearflex®	230 lbs	308 lbs	385 lbs

3. If higher shear values than those shown are required, please contact Verco Engineering Dept.
4. Total slab depth is nominal depth from top of concrete to bottom of steel deck.
5. Concrete fill to be normal weight (145 pcf) and have minimum compressive strength f'_c = 3,000 psi.
6. SV decks with structural concrete fill have a Flexibility Factor of F < 1.
7. Sidelap connections - minimum 1 - #10 screw per span, maximum 36" oc spacing.
8. A continuous 3 span condition is assumed for all span lengths 4 ft and greater. For span lengths less than 4 ft, a 12 ft long sheet is assumed, with a maximum of 7 continuous spans.
9. To convert to nominal values multiply by Ω_d (ASD) = 3.25. To convert to LRFD multiple nominal value by Φ_d = .5

Maximum Unshored Clear Span (ft-in.)

Gage	Span	Total Slab Depth Normal Weight Conc. (145 pcf)						
		3.0" NW	3.5" NW	4.0" NW	4.5" NW	5.0" NW	5.5" NW	6.0" NW
26	1	2'-5"	2'-5"	2'-4"	2'-3"	2'-2"	2'-2"	2'-1"
	2	2'-11"	2'-10"	2'-9"	2'-8"	2'-7"	2'-7"	2'-6"
	3	3'-0"	2'-11"	2'-9"	2'-9"	2'-8"	2'-7"	2'-6"
24	1	3'-3"	3'-2"	3'-1"	3'-0"	2'-11"	2'-10"	2'-9"
	2	3'-11"	3'-9"	3'-8"	3'-6"	3'-5"	3'-4"	3'-3"
	3	3'-11"	3'-10"	3'-8"	3'-7"	3'-6"	3'-4"	3'-3"
22	1	3'-8"	3'-6"	3'-4"	3'-2"	3'-1"	3'-0"	2'-11"
	2	4'-7"	4'-5"	4'-3"	4'-1"	4'-0"	3'-10"	3'-9"
	3	4'-6"	4'-3"	4'-1"	3'-11"	3'-10"	3'-8"	3'-7"

1. Shoring calculations based on the following:
 - Deck supporting dead load of concrete plus 20 psf uniform construction load or 150 pound concentrated construction live load for flexure.
 - Dead load deflection limited to L/180 of span length, not to exceed 3/4".
 - Allowable reactions based on maximum bearing length permitted by AISI S100. Support reactions for unshored spans due to dead loads and uniform construction live loads must be evaluated based on the allowable reactions set forth on page 128.
2. Shoring is required at midspan for spans greater than those shown.

- ≥ 4 in. Total Slab Depth
- Normal Weight Concrete

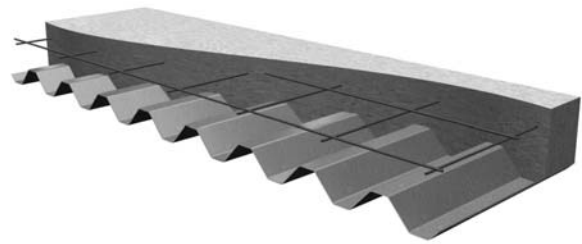

Allowable Interior Diaphragm Shear Strengths, q (plf) and Flexibility Factors, F (in./lb. x 10⁶)

Deck Gage	Total Slab Thickness	Attachment Pattern	Span (ft-in.)								
			2'-0"	2'-6"	3'-0"	3'-6"	4'-0"	4'-6"	5'-0"	5'-6"	6'-0"
26	4.0"	q - 3 screws	1796	1764	1744	1727	1718	1708	1699	1692	1686
		q - 4 screws	1804	1771	1750	1732	1723	1712	1703	1695	1689
		q - 5 screws	1828	1790	1767	1746	1736	1724	1714	1705	1698
		q - 6 screws	1875	1829	1801	1775	1763	1748	1735	1725	1716
	Thickness ≥ 4.5"	q - 3 screws	2098	2066	2046	2029	2020	2009	2001	1994	1988
24	4.0"	q - 3 screws	1858	1814	1787	1764	1752	1737	1726	1716	1709
		q - 4 screws	1868	1823	1794	1770	1758	1743	1731	1721	1712
		q - 5 screws	1899	1848	1817	1789	1775	1758	1745	1734	1724
		q - 6 screws	1961	1899	1861	1827	1811	1790	1773	1759	1748
	4.5"	q - 3 screws	2160	2116	2089	2065	2054	2039	2028	2018	2010
		q - 4 screws	2170	2125	2096	2072	2059	2044	2032	2022	2014
		q - 5 screws	2201	2150	2118	2091	2077	2060	2046	2035	2026
		q - 6 screws	2263	2201	2162	2128	2112	2091	2075	2061	2050
		Thickness ≥ 5.0"	q - 3 screws	2461	2418	2391	2367	2355	2341	2329	2320
22	4.0"	q - 3 screws	1923	1868	1833	1802	1787	1769	1754	1742	1732
		q - 4 screws	1936	1878	1842	1810	1795	1775	1760	1748	1737
		q - 5 screws	1974	1910	1869	1834	1816	1795	1778	1763	1752
		q - 6 screws	2051	1972	1924	1880	1860	1834	1812	1795	1781
	4.5"	q - 3 screws	2225	2169	2134	2104	2089	2071	2056	2044	2034
		q - 4 screws	2238	2180	2143	2112	2096	2077	2062	2049	2039
		q - 5 screws	2276	2211	2171	2135	2118	2097	2079	2065	2053
		q - 6 screws	2352	2274	2225	2182	2162	2135	2114	2097	2083
	5.0"	q - 3 screws	2527	2471	2436	2406	2391	2372	2358	2346	2336
		q - 4 screws	2539	2482	2445	2414	2398	2379	2364	2351	2341
		q - 5 screws	2578	2513	2473	2437	2420	2398	2381	2367	2355
		q - 6 screws	2654	2576	2527	2484	2464	2437	2416	2399	2384
		Thickness ≥ 5.5"	q - 3 screws	2829	2773	2738	2708	2693	2674	2660	2648
20	4.0"	q - 3 screws	1991	1923	1880	1843	1824	1802	1784	1769	1757
		q - 4 screws	2006	1935	1891	1852	1833	1809	1791	1775	1763
		q - 5 screws	2052	1973	1923	1880	1859	1832	1811	1794	1780
		q - 6 screws	2143	2048	1988	1936	1911	1879	1853	1832	1815
	4.5"	q - 3 screws	2293	2225	2182	2145	2126	2103	2085	2071	2059
		q - 4 screws	2308	2237	2192	2154	2135	2111	2092	2077	2064
		q - 5 screws	2354	2275	2225	2182	2161	2134	2113	2096	2082
		q - 6 screws	2445	2350	2290	2238	2213	2180	2155	2134	2116
5.0"	q - 3 screws	2595	2527	2483	2447	2428	2405	2387	2373	2360	
	q - 4 screws	2610	2539	2494	2456	2436	2413	2394	2379	2366	
	q - 5 screws	2656	2577	2527	2484	2462	2436	2415	2398	2383	
	q - 6 screws	2747	2651	2592	2539	2514	2482	2457	2436	2418	
5.5"	q - 3 screws	2897	2828	2785	2748	2729	2707	2689	2674	2662	
	q - 4 screws	2912	2841	2796	2758	2738	2715	2696	2681	2668	
	q - 5 screws	2957	2878	2829	2786	2764	2738	2717	2700	2685	
	q - 6 screws	3048	2953	2894	2841	2816	2784	2758	2737	2720	
Thickness ≥ 6.0"	q - 3 screws	3198	3130	3087	3050	3031	3009	2991	2976	2964	

See footnotes on page 137. See page 131 for vertical loads footnotes.

Deep VERCOR™

- ≥ 4 in. Total Slab Depth
- Normal Weight Concrete

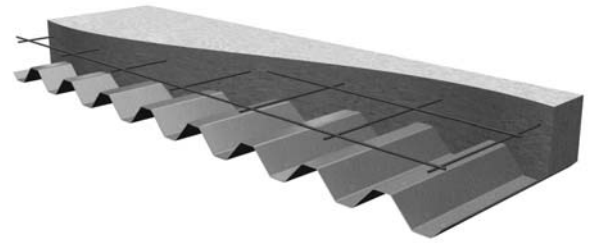

Concrete Properties

Density (pcf)	Uniform Weight (psf)	Uniform Volume (yd ³ /100 ft ²)	Compressive Strength, f' _c (psi)
145	40.4 to 76.7	1.032 to 1.958	3000

Notes:

1. Volumes and weights do not include allowance for deflection.
2. Weights are for concrete only and do not include weight of steel deck.
3. Total slab depth is nominal depth from top of concrete to bottom of steel deck.
4. Uniform and weight volume depend on slab thickness selected. See pages 20-21 for further information.

Footnotes for Maximum Unshored Clear Span and Allowable Diaphragm Shear Strength Tables

1. Interior connections may be #12, #14 or Shearflex® screws.
2. Connections at diaphragm perimeter or other collector elements are to be based on the actual shear to be transferred and the capacity of the connections used.

Allowable Shear Capacity per Connection (lbs)	Fastener Type	1-5/16" DV - Deck Gage			
		26	24	22	20
	#12 Screw	217 lbs	283 lbs	349 lbs	416 lbs
	#14 Screw	251 lbs	327 lbs	404 lbs	482 lbs
	Shearflex®	See table below			

3. If higher shear values than those shown are required, please contact Verco Engineering Dept.
4. Total slab depth is nominal depth from top of concrete to bottom of steel deck.
5. Concrete fill to be normal weight (145 pcf) and have minimum compressive strength f'_c = 3,000 psi.
6. DV decks with structural concrete fill have a Flexibility Factor of F < 1.
7. Sidelap connections - minimum 1 - #10 screw per span, maximum 36" oc spacing.
8. A continuous 3 span condition is assumed for all span lengths less than 4 ft, a 12 ft long sheet is assumed, with a maximum of 7 continuous spans.
9. To convert to nominal values multiply by Ω_d (ASD) = 3.25. To convert to LRFD multiple nominal value by φ_d = .5.

Allowable Interior Shear Strength for Shearflex Screws as Part of Diaphragm System

Screw Designation	Thread Diameter (in)	Screw Length (in)	Steel Deck Panel	Allowable Shear Strength per Connection (lbs)					
				Design Thickness of Structural Support (in.)					
				0.113	0.155	0.187	0.212	0.250	0.313
Shearflex® Standoff Screw	3/8	3	Deep VERCOR™	1283	1356	1461	1495	1464	1418

1. See IAPMO UES ER-0217 and ER-0366 for further information on Shearflex screws.
2. Values shown are based on a maximum of one Shearflex® screw per steel deck rib with the fastener installed at the center of the steel deck rib.

Maximum Unshored Clear Span (ft-in.)

Gage	Span	Total Slab Depth Normal Weight Conc. (145 pcf)						
		4.0" NW	4.5" NW	5.0" NW	6.5" NW	6.0" NW	6.5" NW	7.0" NW
26	1	4'-7"	4'-5"	4'-3"	4'-2"	4'-0"	3'-11"	3'-10"
	2	5'-5"	5'-3"	5'-0"	4'-10"	4'-9"	4'-7"	4'-6"
	3	5'-6"	5'-3"	5'-1"	4'-11"	4'-9"	4'-8"	4'-6"
24	1	5'-8"	5'-5"	5'-3"	5'-1"	4'-11"	4'-9"	4'-8"
	2	6'-9"	6'-6"	6'-3"	6'-0"	5'-10"	5'-8"	5'-6"
	3	6'-10"	6'-7"	6'-4"	6'-1"	5'-11"	5'-9"	5'-7"
22	1	6'-1"	5'-10"	5'-7"	5'-5"	5'-3"	5'-1"	5'-0"
	2	7'-10"	7'-6"	7'-2"	6'-11"	6'-8"	6'-6"	6'-3"
	3	7'-6"	7'-2"	6'-11"	6'-8"	6'-6"	6'-4"	6'-2"
20	1	6'-5"	6'-2"	5'-11"	5'-9"	5'-7"	5'-5"	5'-3"
	2	8'-6"	8'-2"	7'-10"	7'-7"	7'-4"	7'-1"	6'-10"
	3	7'-11"	7'-7"	7'-4"	7'-1"	6'-11"	6'-8"	6'-6"

1. Shoring calculations based on the following:
 - Deck supporting dead load of concrete plus 20 psf uniform construction load or 150 pound concentrated construction live load for flexure.
 - Dead load deflection limited to L/180 of span length, not to exceed 3/4".
 - Allowable reactions based on maximum bearing length permitted by AISI S100. Support reactions for unshored spans due to dead loads and uniform construction live loads must be evaluated based on the allowable reactions set forth on page 129.
2. Shoring is required at midspan for spans greater than those shown.

- 1½ in. Total Slab Depth
- Normal Weight Concrete

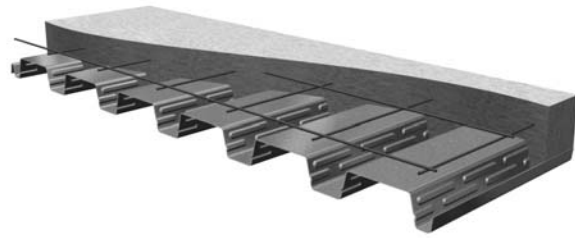

Allowable Interior Diaphragm Shear Strengths, q (plf) and Flexibility Factors, F (in./lb. x 10⁶)

Deck Gage	Total Slab Thickness	Attachment Pattern	Span (ft-in.)								
			4'-0"	5'-0"	6'-0"	7'-0"	8'-0"	9'-0"	10'-0"	11'-0"	12'-0"
22	3.5"	q - 4 screws	1377	1343	1321	1304	1292	1283	1275	1269	1264
		q - 5 screws	1416	1374	1346	1327	1312	1300	1291	1283	1277
		q - 7 screws	1429	1385	1355	1334	1318	1306	1296	1288	1281
	4.0"	q - 4 screws	1679	1645	1622	1606	1594	1585	1577	1571	1566
		q - 5 screws	1718	1676	1648	1628	1613	1602	1593	1585	1579
		q - 7 screws	1731	1686	1657	1636	1620	1608	1598	1590	1583
	4.5"	q - 4 screws	1981	1947	1924	1908	1896	1886	1879	1873	1868
		q - 5 screws	2020	1978	1950	1930	1915	1904	1894	1887	1880
		q - 7 screws	2033	1988	1959	1938	1922	1909	1900	1891	1885
	5.0"	q - 4 screws	2283	2249	2226	2210	2198	2188	2181	2174	2169
		q - 5 screws	2322	2280	2252	2232	2217	2205	2196	2189	2182
		q - 7 screws	2334	2290	2260	2239	2224	2211	2201	2193	2187
Thickness ≥ 5.5"	q - 4 screws	2585	2551	2528	2512	2499	2490	2482	2476	2471	
20	3.5"	q - 4 screws	1417	1375	1347	1327	1312	1300	1291	1283	1277
		q - 5 screws	1463	1412	1378	1354	1335	1321	1310	1300	1293
		q - 7 screws	1479	1425	1388	1362	1343	1328	1316	1306	1298
	4.0"	q - 4 screws	1719	1677	1649	1629	1614	1602	1593	1585	1579
		q - 5 screws	1765	1714	1680	1655	1637	1623	1612	1602	1594
		q - 7 screws	1781	1726	1690	1664	1645	1630	1618	1608	1600
	4.5"	q - 4 screws	2021	1979	1951	1931	1916	1904	1895	1887	1881
		q - 5 screws	2067	2016	1982	1957	1939	1925	1913	1904	1896
		q - 7 screws	2083	2028	1992	1966	1947	1932	1920	1910	1901
	5.0"	q - 4 screws	2322	2280	2252	2232	2217	2206	2197	2189	2183
		q - 5 screws	2369	2318	2283	2259	2241	2227	2215	2206	2198
		q - 7 screws	2384	2330	2294	2268	2248	2233	2221	2211	2203
Thickness ≥ 5.5"	q - 4 screws	2624	2582	2554	2534	2519	2508	2498	2491	2484	
18	3.5"	q - 4 screws	1499	1441	1402	1374	1353	1337	1324	1313	1305
		q - 5 screws	1561	1490	1443	1409	1384	1365	1349	1336	1325
		q - 7 screws	1582	1507	1457	1421	1395	1374	1357	1343	1332
	4.0"	q - 4 screws	1801	1743	1704	1676	1655	1639	1626	1615	1606
		q - 5 screws	1863	1792	1745	1711	1686	1666	1651	1638	1627
		q - 7 screws	1884	1809	1759	1723	1696	1675	1659	1645	1634
	4.5"	q - 4 screws	2103	2044	2005	1978	1957	1941	1928	1917	1908
		q - 5 screws	2165	2094	2047	2013	1988	1968	1952	1940	1929
		q - 7 screws	2185	2110	2061	2025	1998	1977	1961	1947	1936
	5.0"	q - 4 screws	2405	2346	2307	2279	2259	2242	2229	2219	2210
		q - 5 screws	2467	2396	2349	2315	2290	2270	2254	2241	2231
		q - 7 screws	2487	2412	2362	2327	2300	2279	2262	2249	2237
Thickness ≥ 5.5"	q - 4 screws	2706	2648	2609	2581	2560	2544	2531	2521	2512	
16	3.5"	q - 4 screws	1587	1511	1460	1424	1397	1376	1359	1345	1334
		q - 5 screws	1623	1573	1512	1468	1436	1410	1390	1373	1360
		q - 7 screws	1630	1593	1529	1483	1449	1422	1400	1383	1368
	4.0"	q - 4 screws	1888	1813	1762	1726	1699	1678	1661	1647	1636
		q - 5 screws	1966	1875	1814	1770	1737	1712	1692	1675	1661
		q - 7 screws	1992	1895	1831	1785	1750	1724	1702	1685	1670
	4.5"	q - 4 screws	2190	2114	2064	2028	2001	1979	1963	1949	1937
		q - 5 screws	2268	2176	2115	2072	2039	2014	1994	1977	1963
		q - 7 screws	2294	2197	2133	2087	2052	2025	2004	1986	1972
	5.0"	q - 4 screws	2492	2416	2366	2329	2302	2281	2264	2251	2239
		q - 5 screws	2570	2478	2417	2374	2341	2316	2295	2279	2265
		q - 7 screws	2595	2499	2434	2389	2354	2327	2306	2288	2274
Thickness ≥ 5.5"	q - 4 screws	2794	2718	2667	2631	2604	2583	2566	2552	2541	

See footnotes on page 139. See page 131 for vertical loads footnotes.

PLB™ or B FORMLOK™

- 1½ in. Total Slab Depth
- Normal Weight Concrete

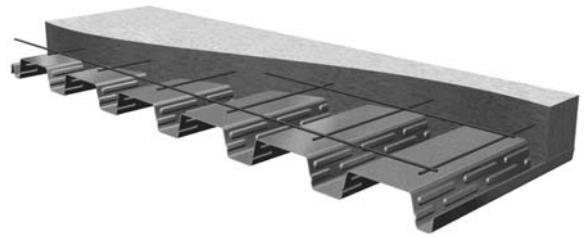

Concrete Properties

Density (pcf)	Uniform Weight (psf)	Uniform Volume (yd ³ /100 ft ²)	Compressive Strength, f' _c (psi)
145	30.6 to 60.8	0.781 to 1.553	3000

Notes:

1. Volumes and weights do not include allowance for deflection.
2. Weights are for concrete only and do not include weight of steel deck.
3. Total slab depth is nominal depth from top of concrete to bottom of steel deck.
4. Uniform and weight volume depend on slab thickness selected. See pages 20-21 for further information.

Footnotes for Maximum Unshored Clear Span and Allowable Diaphragm Shear Strength Tables

1. Interior connections may be #12, #14 or Shearflex® screws.
2. Connections at diaphragm perimeter or other collector elements are to be based on the actual shear to be transferred and the capacity of the connections used.

Allowable Shear Capacity per Connection (lbs)	Fastener Type	PLB & B- FORMLOK Deck Gage			
		22	20	18	16
	#12 Screw	348 lbs	418 lbs	557 lbs	697 lbs
	#14 Screw	403 lbs	484 lbs	645 lbs	807 lbs
	Shearflex®	See table below			

See page 130 or additional footnotes.

Allowable Interior Shear Strength for Shearflex Screws as Part of Diaphragm System

Screw Designation	Thread Diameter (in)	Screw Length (in)	Steel Deck Panel	Allowable Shear Strength per Connection (lbs)					
				Design Thickness of Structural Support (in)					
				0.113	0.155	0.187	0.212	0.250	0.313
Shearflex® Standoff Screw	3/8	3	PLB™, HSB, PLB™-FORMLOK, B-FORMLOK™	1335	1387	1486	1470	1455	1409

1. See IAPMO UES ER-0217 and ER-0366 for further information on Shearflex screws.
2. Values shown are based on a maximum of one Shearflex® screw per steel deck rib with the fastener installed at the center of the steel deck rib.

Maximum Unshored Clear Span (ft-in.)

Gage	Span	Allowable Shear Strength per Connection (lbs)							
		3.5" NW	4.0" NW	4.5" NW	5.0" NW	5.5" NW	6.0" NW	6.5" NW	7.0" NW
22	1	6'-6"	6'-2"	5'-11"	5'-8"	5'-6"	5'-4"	5'-2"	5'-0"
	2	7'-8"	7'-3"	6'-11"	6'-8"	6'-5"	6'-3"	6'-0"	5'-10"
	3	7'-9"	7'-4"	7'-0"	6'-9"	6'-6"	6'-3"	6'-1"	5'-11"
20	1	7'-9"	7'-5"	7'-1"	6'-9"	6'-6"	6'-4"	6'-1"	5'-11"
	2	9'-1"	8'-8"	8'-3"	7'-11"	7'-7"	7'-4"	7'-1"	6'-10"
	3	9'-3"	8'-9"	8'-4"	8'-0"	7'-8"	7'-5"	7'-2"	7'-0"
18	1	8'-10"	8'-5"	8'-1"	7'-9"	7'-6"	7'-3"	7'-1"	6'-11"
	2	10'-8"	10'-2"	9'-9"	9'-4"	9'-0"	8'-8"	8'-4"	8'-1"
	3	11'-0"	10'-5"	10'-0"	9'-7"	9'-3"	8'-11"	8'-8"	8'-5"
16	1	9'-6"	9'-1"	8'-8"	8'-4"	8'-1"	7'-10"	7'-7"	7'-5"
	2	11'-10"	11'-3"	10'-9"	10'-4"	9'-11"	9'-7"	9'-3"	9'-0"
	3	11'-7"	11'-2"	10'-9"	10'-4"	10'-0"	9'-8"	9'-5"	9'-2"

1. Shoring calculations based on the following:
 - Deck supporting dead load of concrete plus 20 psf uniform construction load or 150 pound concentrated construction live load for flexure.
 - Dead load deflection limited to L/180 of span length, not to exceed 3/4".
 - Allowable reactions based on maximum bearing length permitted by AISI S100. Support reactions for unshored spans due to dead loads and uniform construction live loads must be evaluated based on the allowable reactions set forth on page 130.
2. Shoring is required at midspan for spans greater than those shown.

Metric (SI) Conversions

	US	Multiplied by	= Metric		US	Multiplied by	= Metric
Length	in.	x	25.4 = mm	Mass	oz	x	28.34952 = g
	in.	x	2.54 = cm		lb	x	0.4535924 = kg
	ft	x	304.8 = mm		plf	x	1.488164 = kg/m
	ft	x	30.48 = cm		psf	x	4.882428 = kg/m ²
	ft	x	0.3048 = m		pcf	x	16.01846 = kg/m ³
Area	in. ²	x	645.16 = mm ²	Force	lb	x	4.448222 = N
	in. ²	x	6.4516 = cm ²		plf	x	14.5939 = N/m
	ft ²	x	0.09290304 = m ²		psi	x	6.894757 = kN/m ²
Volume	in. ³	x	16,387.06 = mm ³		psf	x	47.88026 = N/m ²
	in. ³	x	16.38706 = cm ³		in.-lb (in.-kips)	x	0.1129848 = Nm (kNm)
	ft ³	x	0.02831685 = m ³	in.-lb/ft (in.-kips/ft)	x	0.3706850 = Nm/m (kNm/m)	
Moment of Inertia	in. ⁴	x	416231.4 = mm ⁴	Flexibility	in./lb x 10 ⁶	x	5.71015 = mm/N x 10 ⁶
	in. ⁴	x	41.62314 = cm ⁴		Galvanizing	oz/ft ²	x
	in. ⁴ /ft	x	1365588 = mm ⁴ /m	Paint		mil	x
	in. ⁴ /ft	x	136.5588 = cm ⁴ /m				
Section Modulus	in. ³ /ft	x	53763 = mm ³ /m				
	in. ³ /ft	x	53.763 = cm ³ /m				

Metric Definitions:

"m" - meter "kg" - kilogram
 "cm" - centimeter "N" - Newton
 "mm" - millimeter "Pa" - Pascal
 "g" - gram

Note: "Metric" is the common term used to refer to measurements denoted by the formal term "Standard International" or "SI."

Conversion factors and notation as per IEEE/ASTM SI 10-2010 and common mathematical practices.

The PunchLok II tool and the method of using it are the subject of U.S. Patent No. 6,212,932, U.S. Patent No. 6,397,469 and/or U.S. Patent No. 8,667,656.

VERCO®, PUNCHLOK®, SHEARTRANZ®, and HSB®, are registered trademarks of Verco Decking, Inc. PLB™, PLW2™, PLW3™, PLN3™, PLN™, VERCOR™, and FORMLOK™ are trademarks of Verco Decking, Inc. All other names may be trademarks of their respective owners. All rights reserved.

VERCO DECKING, INC., reserves the right to change the design or details of its products without notice. The information in this catalog is presented for general information only and is not to be used or relied upon for any application without complete review of the proposed application and without a complete review by a licensed professional architect, engineer, designer or other qualified professional.

VERCO DECKING, INC. assumes no liability whatsoever for the accuracy or completeness of the information contained herein.

VERCO DECKING, INC., makes no representation or warranty of any kind, either express or implied, respecting any information contained in this catalog including, but not limited to, the accuracy, completeness or suitability of such information for any particular purpose or use.

In addition, VERCO DECKING, INC., expressly disclaims any liability for incidental, special, consequential or punitive damages including, but not limited to, loss of profits or loss of use.

VERCO DECKING, INC.'S liability, warranties and other obligations with respect to its decking products are set forth in the VERCO DECKING, INC. Terms and Conditions of Sale provided to Buyer in connection with the provision of such decking products.

As used herein, references to VERCO DECKING, INC., includes any parents, affiliates and subsidiaries.

INDEX

- A**
 - Accessories 29
 - Acoustical Cellular FORMLOK deck 34
 - Acoustical Insulation 34
 - Appearance 14, 35
 - Attachment
 - Button punches 11
 - Deep VERCOR™ 129
 - Mechanical Fasteners 11
 - Parallel collectors 12
 - PLB™ or B FORMLOK™ 38, 130
 - PLN™ or N FORMLOK™ 98
 - PLN3™ or N3 FORMLOK™ 86
 - PLW2™ or W2 FORMLOK™ 50
 - PLW3™ or W3 FORMLOK™ 68
 - Screws 11
 - Shallow VERCOR™ 128
 - Sidelaps 11
 - Supports 10
 - Welds 10, 11
- B**
 - B FORMLOK™ Tables 40–48
 - BCD FORMLOK™ Tables 110, 116
 - Bearing 15
 - Button punches 11
- C**
 - Cantilevered FORMLOK deck 6
 - Cellular Acoustical FORMLOK Deck 34
 - Cellular Deck 109
 - Closures 29
 - Concentrated loads 5
 - Concrete
 - Placement 15
 - Thickness 7
 - Types 7
 - Volumes and weights 20
 - Concrete fill 7
 - Concrete reinforcing 7
- D**
 - Deep VERCOR™
 - Concrete Properties 137
 - Diaphragm Tables 136
 - Footnotes 137
 - Section Properties 129
 - Uniform Load Tables 132
 - Design example 18
 - Diaphragms 9
 - Dimensions
 - Deep VERCOR™ 129
 - PLB™ or B FORMLOK™ 38, 130
 - PLB™-CD or BCD FORMLOK™ 110
 - PLN™ or N FORMLOK™ 98
 - PLN™-CD or NCD FORMLOK™ 114
 - PLN3™ or N3 FORMLOK™ 86
 - PLN3™-CD or N3CD FORMLOK™ 113
 - PLW2™ or W2 FORMLOK™ 50
 - PLW2™-CD or W2CD FORMLOK™ 111
 - PLW3™ or W3 FORMLOK™ 68
 - PLW3™-CD or W3CD FORMLOK™ 112
 - Shallow VERCOR™ 128
- E**
 - Exposed product appearance 14
- F**
 - Finishes 13
 - Fire resistance ratings 8
 - Floor deck concrete fill 7
 - Floor deck design considerations 7
 - Floor deck diaphragms 9
- G**
 - Gage selection 15
 - Galvanized with primer 14
- H**
 - Hanging loads 6
 - Hilti fasteners 11, 12
 - How to use tables 36
- L**
 - Loads, concentrated 5
- M**
 - Material 4
 - Mechanical Fasteners 11
 - Metric conversions 141
- N**
 - N FORMLOK™ Tables 97, 100–108
 - N3 FORMLOK™ Tables 85, 88–96
 - Noise Reduction Coefficients 34
- O**
 - Overhanging 6
- P**
 - Parallel collector attachment 12
 - Parking structures 6
 - PLB or B FORMLOK™
 - Concrete Properties 139
 - Footnotes 139
 - PLB™ FORMLOK™ Tables 40–48
 - PLB™ or B FORMLOK™ Tables 130, 138
 - PLB™-CD FORMLOK™ Tables 110, 116
 - PLN™ FORMLOK™ Tables 97, 100–108
 - PLN™-CD or NCD FORMLOK™
 - Tables 114, 120
 - PLN3™ FORMLOK™ Tables 85, 88–96
 - PLN3™-CD or N3CD FORMLOK™
 - Tables 113, 119
 - PLW2™ and W2 FORMLOK™
 - Tables 49, 52–60
 - PLW2™-CD or W2CD FORMLOK™
 - Tables 111, 117
 - PLW3™ and W3 FORMLOK™
 - Tables 67, 70–78
 - PLW3™-CD or W3CD FORMLOK™
 - Tables 112, 118
 - Pneutek fasteners 11, 12
 - Primered deck 13, 14
 - Profiles
 - Designations 4, 12, 33
 - Summary 2
 - Properties
 - Deep VERCOR™ 129
 - PLB™ or B FORMLOK™ 38, 130
- R**
 - Reinforcing 7
- S**
 - Screws 11, 12
 - Shallow VERCOR™
 - Concrete Properties 135
 - Diaphragm Tables 134
 - Footnotes 135
 - Section Properties 128
 - Uniform Load Tables 131
 - Sidelap connections 11
 - Sound transmission 35
 - Spans 14
 - Specification 35
 - Steel headed stud anchors 10, 25
 - Superimposed load tables 5
- T**
 - Top seam welds 11
- U**
 - Uniform Load Tables 5
 - Cellular Deck 121–126
 - Deep VERCOR™ 132
 - PLW2™ or W2 FORMLOK™ 61–63
 - PLW2™-CD or W2CD FORMLOK™ 121–123
 - PLW3™ or W3 FORMLOK™ 79–81
 - PLW3™-CD or W3CD FORMLOK™ 124–126
 - Shallow VERCOR™ 131
- V**
 - Venting 8
 - Vertical loads 5
 - Vibrations 7
- W**
 - Weights
 - Deep VERCOR™ 129
 - PLB™ or B FORMLOK™ 38, 130
 - PLB™-CD or BCD FORMLOK™ 110
 - PLN™ or N FORMLOK™ 98
 - PLN™-CD or NCD 114
 - PLN3™ or N3 FORMLOK™ 86
 - PLN3™-CD or N3CD FORMLOK™ 113
 - PLW2™ or W2 FORMLOK™ 50
 - PLW2™-CD or W2CD FORMLOK™ 111
 - PLW3™ or W3 FORMLOK™ 68
 - PLW3™-CD or W3CD FORMLOK™ 112
 - Shallow VERCOR™ 128
 - Welds 11

THE PunchLok[®] SYSTEM CARRIES THE LOAD

In 2001, prior to the release of the original PunchLok System, Verco engineers conducted a test to demonstrate the capabilities of the Verco Sidelap Connection (VSC) made by the PunchLok tool to resist the vertical loads during typical construction processes including: heavy foot traffic, staging of construction materials and pouring of concrete.

Three 10' long panels of 20 gage PLB™-36 roof deck were secured to a structural frame with arc spot welds using a 36/4 attachment pattern. Sidelaps were secured with the PunchLok tool using four VSC's per span. Load equivalent to 138 psf was applied to the center panel by adding water to steel drums stacked three rows high. The two outside deck panels were not loaded. As shown in the photograph, the load from the center panel was transferred to the adjacent unloaded sheet entirely through the four VSC's between the panels.

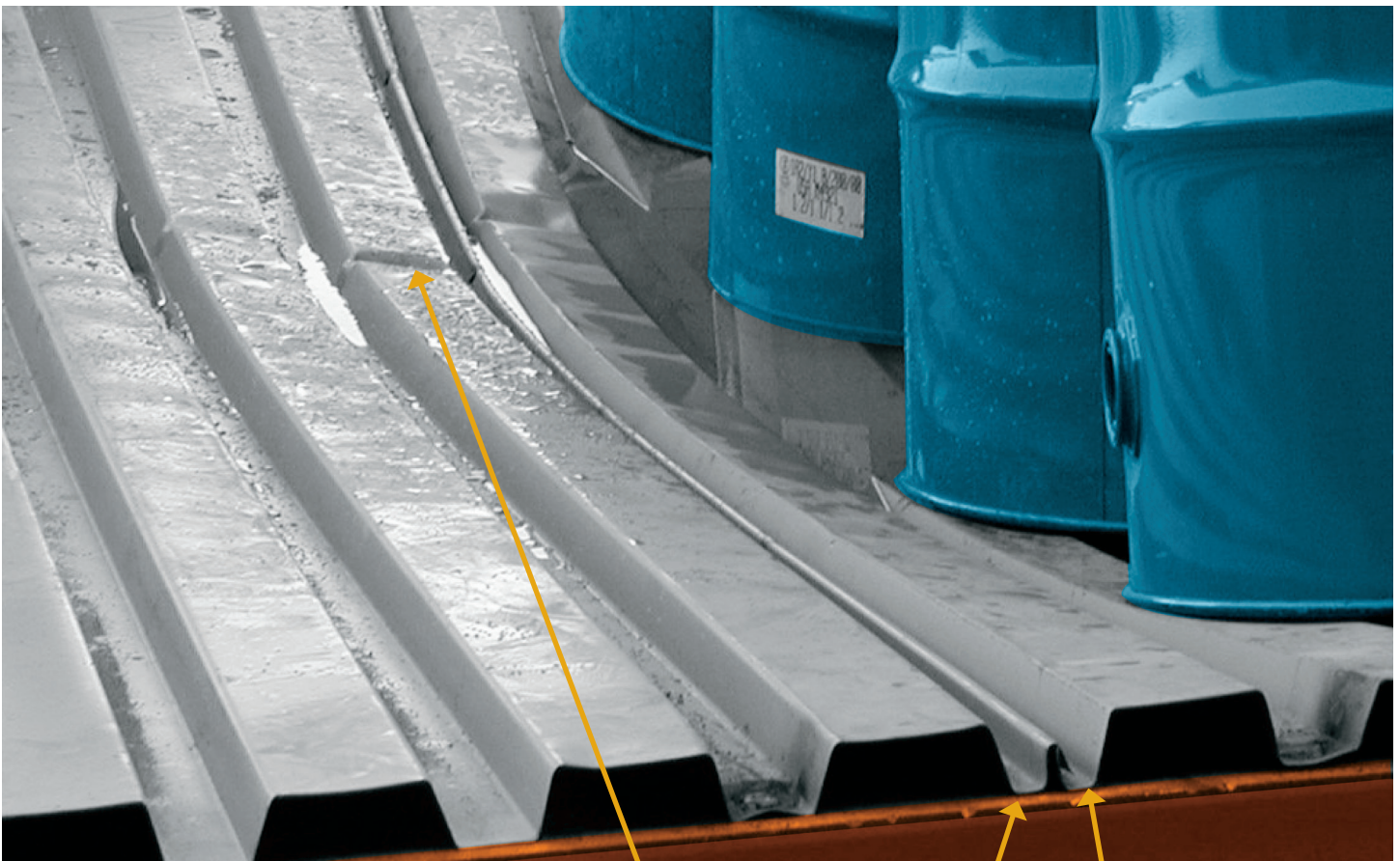

Buckling at the top flange of the adjacent unloaded deck panel demonstrates the vertical load transfer capabilities of the VSC

Female Sidelap

Male Sidelap

While under load and after the test, there were no signs of disengagement or slippage of any type on the VSC's made with the original PunchLok tool. The top flange of the adjacent "unloaded" panel was buckled due to the load transferred entirely thru the Verco Sidelap Connection. This demonstrates the excellent ability of the PunchLok system to transfer vertical load across the sidelaps.

Verco's new sidelap connection (VSC2) is even stronger than the original VSC! Expect equivalent results from the new

[Catalog VF5](#)

PunchLok[®] II
SYSTEM

1964  2014
VERCO DECKING, INC.
HONORING THE PAST | CELEBRATING THE PRESENT | EMBRACING THE FUTURE

DIVISION HEADQUARTERS

4340 N. 42nd Avenue
Phoenix, Arizona 85019
Tel (602) 272-1347
www.vercodeck.com

DISTRICT SALES OFFICES

Northern California

Tel (916) 488-8180
Fax (916) 488-8099
NorthernCaliforniaSales@vercodeck.com

Southern California

Tel (714) 939-9128
Fax (714) 939-9109
SouthernCaliforniaSales@vercodeck.com

Phoenix – Arizona

Tel (623) 385-1649
Fax (623) 385-1660
PhoenixSales@vercodeck.com

Salt Lake City – Utah

Tel (801) 292-0730
Fax (801) 621-0927
SaltLakeCitySales@vercodeck.com

Seattle – Washington

Tel (425) 883-8250
Fax (425) 882-0134
SeattleSales@vercodeck.com

ENGINEERING OFFICES

Northern California

Seattle – Washington
Tel (510) 792-8370
Fax (510) 792-2429
VercoEngineeringNW@vercodeck.com

Southern California

Tel (714) 938-0307
Fax (714) 938-0340
VercoEngineeringSoCal@vercodeck.com

Phoenix – Arizona

Salt Lake City – Utah
Tel (623) 385-1651
Fax (623) 385-1660
VercoEngineeringPHX@vercodeck.com

MANUFACTURING PLANTS

Antioch, California
Fontana, California
Phoenix, Arizona

LITERATURE REQUEST

Fax (510) 792-2429
literature-request@vercodeck.com

PunchLok® II

S Y S T E M

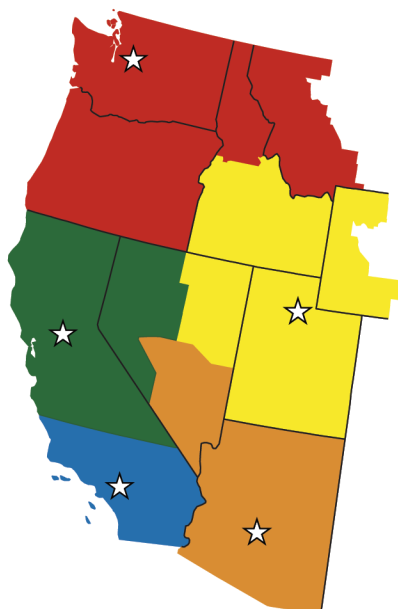
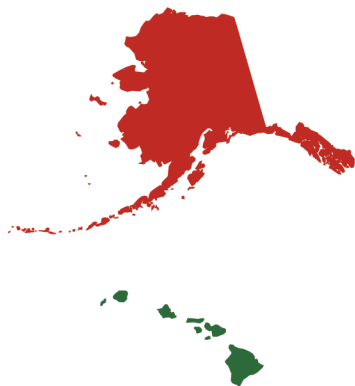

SALES TERRITORIES

VF5



LEVERAGING TECHNOLOGY. CREATING SOLUTIONS.